

OCEANIA

This program is free software; you can redistribute it and/or modify it under the terms of the GNU General Public License as published by the Free Software Foundation; either version 2 of the License, or (at your option) any later version.

As a special exception, permission is granted to include this font program in a Postscript or PDF file that consists of a document that contains text to be displayed or printed using this font, regardless of the conditions or license applying to the document itself.

This program is distributed in the hope that it will be useful, but WITHOUT ANY WARRANTY; without even the implied warranty of MERCHANTABILITY or FITNESS FOR A PARTICULAR PURPOSE. See the GNU General Public License for more details.

To Daniela

PREFACE

This is OCEANIA, the font from the logo of the Australian television series OCEAN GIRL. It has a rather decorative style and should be most appropriate for use in headlines. The history of the typeface reaches back to approximately 1993 during the production of the first season of OCEAN GIRL. Phil Watts who was a member of the crew already at that time has some memories about who created it:

From: Phil Watts
 To: Peter Backes
 Subject: Re: ocean girl font
 Date: 28 Oct 2002
 Organization: Jonathan M. Shiff Productions

Hi Peter

[. . .]

The font in question was especially designed by a graphic designer who was hired by the production designer. As far as I know it never even made it to a computer font, and only the letters needed where ever designed.[. . .]

Phil Watts

-*-*-

From: Phil Watts
 To: Peter Backes
 Subject: Re: ocean girl font
 Date: 02 Nov 2002
 Organization: Jonathan M. Shiff Productions

Hi Peter,

Yes, I remember who designed the original font—his name was Phil Cordingly—think he worked for the ABC television network at the time (www.abc.net.au)[. . .]

[. . .]Yes, the font looks good, and I agree with you about the ‘O’. It’s the kind of font that looks better underused, if you know what I mean.

Phil

Note that there is a less known fact that not only the letters ‘O’, ‘C’, ‘E’, ‘A’, ‘N’, ‘G’, ‘I’, ‘R’, ‘L’ and an ‘O’ with the lower left quarter of the circle cut out (as part of the ORCA logo) can be seen in the series, but also an ‘T’ and ‘Y’ in the third episode of the second season in the banner of ORCA CITY (an installation of interconnected underwater research stations at the ocean floor) and further ‘D’ and ‘S’ in the alternative title OCEAN ODYSSEY used in the United Kingdom for the series.

Phil Watts remembers that he did the additional letters for ORCA CITY and OCEAN ODYSSEY:

From: Philip Watts
 To: Peter Backes
 Subject: Re: Ocean Girl font version 1.08
 Date: 07 Jul 2005
 Organization: Jonathan M. Shiff Productions

Hi Peter,

[. . .] By-the-way—It was me who did that artwork for the “Ocean Odyssey” title for the UK. Takes me back!

Phil Watts

-*-*

From: Philip Watts
To: Peter Backes
Subject: Re: Ocean Girl font version 1.08
Date: 13 Jul 2005
Organization: Jonathan M. Shiff Productions

Hi Peter,

That's correct—I did those extra letters . . . At least, I'm assuming I must have done ORCA CITY as well, because I think it was on one of the computer screen displays I did.

[. . .]

Phil

All other letters not in one of the logos were designed by myself. The principles on which the construction of the letterforms is based are actually quite simple, so it was not that hard to guess how most letters are supposed to look like. Nevertheless it has taken a long time until the font reached an adequate uniformness (with long breaks in between, as I have of course not been working full time on it). I didn't know about such elementary things in typography as overshoot, descenders and ascenders etc. until recently. I also didn't know about the fine points of font rendering. So the first versions of this font were actually quite crude, with bad dimensions everywhere, no kerning, no hinting (except in the old Type 1 version an awful automatic hinting done by the conversion software). Some of the problems could be corrected in the old versions, for example the extremely tight spacing between letters in the early drafts of the font.

However the software used for the design of old versions, COREL DRAW, really had it's limits concerning font design. I mostly used it because it was the only software which was accessible to me that offered some functionality of writing a font file, and because it was quite straight forward to use. The very first draft of the font was actually even sketched in POWERPOINT. Every program has two purposes, one for which it was written and another one for which it wasn't. This was surely an application of the program for which it was neither written nor which was one of it's purposes, so COREL DRAW offered some real improvements for me. Actually it's curve drawing functionality is quite sophisticated and based on the same principles as the glyphs in Type 1 fonts, which luckily made the conversion to real font processing software quite easy. Even today I use COREL DRAW from time to time to sketch letters, so I can quickly see if some idea I have works or not. It's more comfortable than drawing on paper with pencil and eraser.

Now this is the all new, greatly improved version of OCEANIA with plenty of new accented letters, lower case and some symbols, covering all of Adobe StandardEncoding and ISO-8859-1 plus the Euro symbol. I choose METATYPE1 as the design software because I like the idea of programming a font by describing the mathematical relations underlying the constructions of the letterforms. And because it is based on a programming language whose source code files are ASCII text files, I am not dependent on some proprietary binary files which noone can read anymore in a few years. It also makes it possible for me to have the font under real revision control instead of making copies of the COREL DRAW files everytime a stable state has been reached. Finally there is support for literate programming so you can now read the font's construction program together with these lines beautifully typeset by \TeX . METATYPE1 is an excellent program, excellent in it's idea and in it's design, but the extreme uniformness of the font revealed some deficiencies which required modification of the underlying engine. I have given back the improvements I made to the program and sent patches to the authors so hopefully it will be part of the next official version.

The readme file says something mysterious about that the differences between this font and the official one has become negative. This is because this font is now actually kind of the official font, as it is the one which Animation Works were using on the web page for their animated OCEAN GIRL series. (I don't like it, it's like Arielle and doesn't have any relation at all to the live action series.)

A derivative of a very early version of this font was also used in the intro of the animated series itself, you can notice this at the lower left of the 'O' where they tried to 'repair' the part that had been cut out. It's quite subtle so you have to look closely. It was during the production of the series in 1998 when I contacted Animation Works because I was interested in what their new animated series would look like. It took quite some time until there was a reaction, mainly because of the mail address I had written to. But when I got a reply I was astonished that it actually was from someone of the crew, Sam Venning, and not from a public

relations manager who writes you five lines of text that doesn't really say anything, doesn't answer any of your questions and only praises how great the show is. Sam Venning was responsible for the editing of THE NEW ADVENTURES OF NERI, so he did about the same job as Phil Watts for the real live action series. (Interesting to note that they met once at a party, as I was told by Phil.) I coincidentally mentioned the existence of an early version of the OCEANIA font and I was even more surprised to learn that there was a need for it.

From: Sam Venning
 To: Peter Backes
 Subject: RE: Ocean Girl Series 5
 Date: 10 Dec 1998
 Organization: Animation Works

[. . .]

I would be really keen to get a digital copy (Corel?) of the logo from the original series. I've sent an email to the original series producers (Jonathan M. Shiff Productions) but they seem a bit busy to get around to sending me a copy. I'd really like to provide you with something in return. Wait and I'll see what I can do.

[. . .]

Regards,

Sam

It is a good feeling to know that not only fans of OCEAN GIRL have this problem of communicating with Jonathan M. Shiff Productions. I sent him the font, together with some 3D scenes for rendering the title screen and I exchanged a few more mails with Sam, but he got very busy with the production and so he couldn't provide me with something in return. But that is okay for me as it is a honor to have my work used in such a TV production, even though I was not quite in the target audience anymore. Sam isn't credited on the Animation Works web page, too, and he was even working full time on it.

Concerning the 3D scenes of the title screen, I don't know if it was used by them, but it is quite possible. (The letters in the title screen now rotate much faster and in the opposited direction compared to the version I sent them, and they are faded instead of rotated out.)

Liz O'Dea kindly collected information from Sam and another former member of Animation Works' OCEAN GIRL team about what they did with the font and how they got the TrueType version running on the Mac.

From: Liz O'Dea
 To: Peter Backes
 Subject: RE: ocean girl
 Date: 02 Nov 2002
 Organization: Animation Works

> I heard you have some Macs in use. Have you succeeded to install the font on Macs? If so I
 > would be thankful for some positive feedback so I can add to the README that someone has
 > confirmed it's usable on Macs. It would be great if you could add one or two words on how to
 > install it (never used Macs myself and don't know anything about them).

[. . .]Neither of the editors who worked on the animated OG series work here now, but they have responded to your technical query via email ...

David. I used a mac font utility called TT Font Converter to create a Mac font from the one he sent to us (which was pc). In general, all True Type fonts are scalable for media/tv type usage. The utility just makes it Mac Friendly.

(From memory, there were some letters with circles in them instead of lines and they confused people.)

Sam. Here is a bit of technical info about the font. It is a TrueType front. TrueType fonts can be used on both Apple Macintosh and Microsoft Windows computers. I believe TrueType is a technology jointly developed by Apple and Microsoft. While TrueType fronts can be used on both Apple Macintosh and Microsoft Windows computers the font needs go through a simple conversion process first. A shareware (public domain) piece of software called TTConverter 1.5 is available on the Macintosh platform to do this. It hasn't been updated since July 1993!

[. . .]

I've used the converter on the Ocean Girl font and it works just fine. The only odd thing is that during the conversion the name of the font (the name that appears in the font menu) changes. I can't remember what it becomes but it isn't "Ocean Girl". Still, it is easy enough to locate in the menu and use.

I hope this helps you with the Mac question!

Kind regards,

Liz O'Dea

OCEANIA has also been used on numerous OCEAN GIRL web pages of which Martin Requart's is surely the most important to mention. I am disappointed that some people don't use the most recent version, there are still pages out there on which I am confronted with my ugly first attempts with tight spacing, straight lines instead of curves etc. Please update, this new version looks so much better.

Concerning the name of the game, 'Oceania' is a term used to designate the various islands of the South Pacific, including Australia. In THE NEW ADVENTURES OF NERI, the home planet of Neri is called 'Oceana,' which sounds similar, in contrast to the live action series, where it is exclusively referred to as 'The Planet Of The Oceans.' However no relation is intended (although Sam Venning used 'Oceania' in one of his mails in 1998, but that might have been a typo). After all I have chosen the name to show my admiration of Oceania as one of the most beautiful places on earth, used also for filming the wonderful live action series.

Finally, I want to thank David Banz for his great help in converting the font between formats. The Euro character is especially dedicated to you, David!

December 2005

Peter Backes

PREAMBLE

input fontbase;

The font has been designed using native Type 1 size, so this essentially defines a 1:1 mapping of the coordinates.

pf_info_designsize 1000;

The placing of points in OCEANIA is done according to a very strict grid system. The total height of an uppercase character has been divided into 16 equally sized parts, called an extended unit (*xu*). Sometimes it was necessary to specify points with a finer granularity, for this purpose the extended unit consists of eight basic units. The size of vertical and horizontal main strokes of OCEANIA relate 3 : 2. These dimensions have been measured in a high resolution printing on the title page of the OCEAN GIRL book, in a frame capture of the OCEAN GIRL intro scene and in an autotraced outline used by Jonathan M. Shiff Productions in the flash animations on their web page.

```

s# := 0; % Extra space at the left and right
u# := 8; % Unit size
xu# := 5u#; % Entended unit size
xgap# := 2xu#; % Serif size
ygap# := xu#; % Not used
ht# := 80u#; % Hight of capitals
o# := u#; % Overshoot
px# := 3xu#; py# := 2xu#; % Stroke width
ho# := o#;
leftstemloc# := xu# + s#; % Position of left stem
rightbear# := xu# + s#; % Space at the right
dotheight# := 3.6xu#; % Height of the dots, analogous to bars.
xheight# := .5ht# + py#; % Height of lowercase x

```

The font has several characteristic crescents which appear in most characters: The ones used at the outside of the strokes, the ones used at the inside and those used at the bottom left of some stems. These quantities specify the size of these crescents.

```

lbow# := 19u#; lctl# := 7u#; % I bow dimensions
obow# := 4xu#; octl# := .5 * obow#; % Crescent dimensions
ibow# := .5 * obow#; ictl# := .5 * ibow#; % Inner bow dimensions

```

```

space# := 12xu# + 2s#;
space_stretch# := 6xu#;
space_shrink# := 4xu#;
quad# := 36xu# + 2s#;

```

```

define_ps_units(ht, s, u, xu, o, ho, space, space_stretch, space_shrink, quad);
define_whole_ps_units(xgap, ygap, leftstemloc, rightbear, dotheight, xheight);
define_whole_ps_units(lbow, lctl, obow, octl, ibow, ictl);
define_even_ps_units(px, py);

```

This is the information for the Type 1 font format. It describes the name of the font as it will appear in the menu, copyright information, position of the design lines and stem alignment zones for the hinting engine. The version number is read from the topmost record in the the HISTORY file.

```

begingroup save s, t, i; string t;
for s := 0 upto 24:
  t := readfrom "HISTORY";
  exitif t = EOF;
  if substring(0, 2) of t = "*_":
    for i := 22 downto 2:
      if substring(i - 1, i) of t <> "_":
        message "<VERSION_" & substring(2, i) of t & ">";

```

```

    pf_info_version substring(2, i) of t;
  fi
  exitif substring(i - 1, i) of t <> " ";
endfor
fi
exitif substring(0, 2) of t = "* ";
endfor
endgroup;
pf_info_quad quad;
pf_info_space space, space_stretch, space_shrink;
pf_info_familyname "Oceania";
pf_info_weight "Regular";
pf_info_fontname "OCEANIA", "Oceania";
pf_info_pfm "Oceania", 0, 0;
pf_info_author "(c) 1998-2000, 2004 The PLASMA Organization.
& "All Rights Reserved.";
pf_info_encoding "FontSpecific";
pf_info_italicangle 0;
pf_info_underline -100, 50;
pf_info_fixedpitch false;
pf_info_ascender ht + xu;
depth := 200;
pf_info_descender -200;
pf_info_adl ht + xu, 200, 0;
blue_fuzz := 0;
blue_scale := 0.03963;
blue_shift := 7;
pf_info_overshoots(0, -o), (ht, o), (xheight, o), (descender, -eps);
pf_info_capheight ht;
pf_info_xheight xheight;
pf_info_creationdate "03.03.1998_20:26:45";
italic_shift := 0;
math_axis := .5ht;
% UniqueID
% FontMatrix 0.001 0 0 0.001 0 0
% FontBBox 40 0 696 640
% StdHW
% StdVW
% StemSnapH
% StemSnapV
%use_emergency_turningnumber;
def stem_crescent(suffix p, q) =
  z_p .. controls(x_p, y_p - lctl) and (x_q - lctl, y_q) .. z_q enddef;

```

For the crescent features of the letters not to be straight lines, appropriate tangents need to be specified for the starting and ending points. These tangents are being calculated by this macro.

```

vardef bend @#(suffix p*, q*)(expr ctl*, scale*) =
  begingroup
  save left, right, up, down;
  def left(suffix p, q)(expr ctl, scale) = z_p .. controls
    (x_p - abs(xpart scale) * ctl, y_p) and (x_q, y_q + (ypart scale) * ctl) .. z_q enddef;
  def up(suffix p, q)(expr ctl, scale) = z_p .. controls
    (x_p, y_p + abs(ypart scale) * ctl) and (x_q + (xpart scale) * ctl, y_q) .. z_q enddef;
  def right(suffix p, q)(expr ctl, scale) = z_p .. controls
    (x_p + abs(xpart scale) * ctl, y_p) and (x_q, y_q - (ypart scale) * ctl) .. z_q enddef;
  def down(suffix p, q)(expr ctl, scale) = z_p .. controls
    (x_p, y_p - abs(ypart scale) * ctl) and (x_q - (xpart scale) * ctl, y_q) .. z_q enddef;

```

```

    @#(p*, q*)(ctl*, scale*)
endgroup
enddef;

```

If two outline crescents intersect, as for example in the ‘8’, then it will result in a bay. This is a macro to calculate the tangents at the start, end and intersection points.

```

vardef bay @#(suffix p*, q*) =
begingroup
save left, right, up, down;
def left(suffix p, q)(expr ctl) = z_p .. controls
(x_p - .4 * ctl, y_p - .3ctl) and (x_q, y_q + .7 * ctl) .. z_q enddef;
def right(suffix p, q)(expr ctl) = z_p .. controls
(x_p + .4 * ctl, y_p + .3ctl) and (x_q, y_q - .7 * ctl) .. z_q enddef;
def up(suffix p, q)(expr ctl) = z_p .. controls
(x_p, y_p + .7 * ctl) and (x_q + .4 * ctl, y_q - .3ctl) .. z_q enddef;
def down(suffix p, q)(expr ctl) = z_p .. controls
(x_p, y_p - .7 * ctl) and (x_q - .4 * ctl, y_q + .3ctl) .. z_q enddef;
@#(p*, q*)(octl)
endgroup
enddef;

```

The macro **bend** above was written in a flexible fashion, it can actually deal with different crescents of different sizes. Here are some macros for convenience which describe the tangents of the crescents most often used throughout the character set. **small_crescent** and **small_bow** are outer and inner crescents used in some lowercase characters, while **crescent** and **bow** have a bigger size and are more common. **med_crescent**, **med_bow** and **mini_bow** are for superior and circled characters.

```

vardef small_crescent @#(suffix p, q) = bend @#(p, q)(octl, (.8, .8)) enddef;
vardef small_bow @#(suffix p, q) = bend @#(p, q)(ictl, (-.6, -.6)) enddef;
vardef med_crescent @#(suffix p, q) = bend @#(p, q)(octl, (.5, .5)) enddef;
vardef med_bow @#(suffix p, q) = bend @#(p, q)(ictl, (-.8, -.8)) enddef;
vardef mini_bow @#(suffix p, q) = bend @#(p, q)(ictl, (-.4, -.4)) enddef;
vardef crescent @#(suffix p, q) = bend @#(p, q)(octl, (1, 1)) enddef;
vardef bow @#(suffix p, q) = bend @#(p, q)(ictl, (-1, -1)) enddef;

```

This is a handy macro to save typing. It sets the dimensions of a character to the specified width, height, depth and italic correction.

```

def fix_dimens(expr w, h, d, i) =
wd.glyph_name := w;
ht.glyph_name := h;
dp.glyph_name := d;
ic.glyph_name := i;
enddef;

```

CONSTRUCTION OF LETTERFORMS

Construction of the character breve:

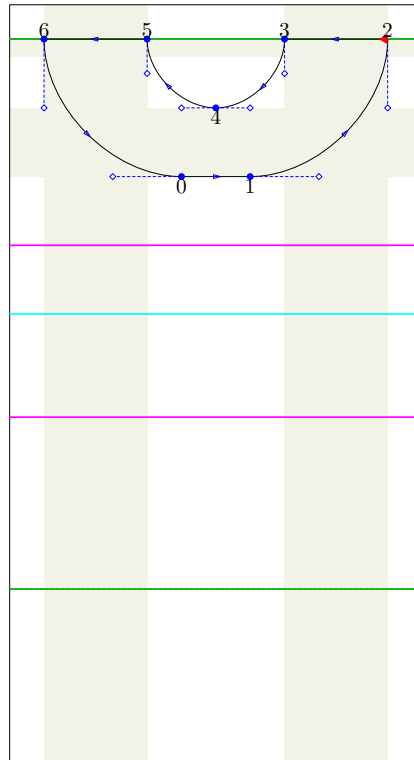

```

beginfont
encode("breve")(5); standard_introduce("breve");
beginglyph(breve);
 $y_0 = y_1 = lc\_height + 2xu; x_6 = leftstemloc;$ 
 $x_5 - x_6 = x_2 - x_3 = px; y_4 - y_0 = py;$ 
 $hh_0 := y_4;$ 
 $z_2 = z_1 + (obow, obow); z_4 = z_3 - (ibow, ibow); z_5 = z_4 + (-ibow, ibow); z_0 = z_6 + (obow, -obow);$ 
Fill  $z_0$  -- crescent right(1, 2) -- bow down(3, 4) & bow left(4, 5)
  -- crescent down(6, 0) & cycle;

ghost_stem top;
fix_vstem(px)(glyph_stored.glyph_name 1);
fix_hstem(py)(glyph_stored.glyph_name 1)( $y \leq hh_0$ );
fix_dimens( $x_2 + rightbear, y_2, 0, 0$ );

just_labels bot(0, 1, 4);
just_labels top(2, 3, 5, 6);

standard_exact_hsbw("breve");
endglyph;

```

Construction of the character dotaccent:

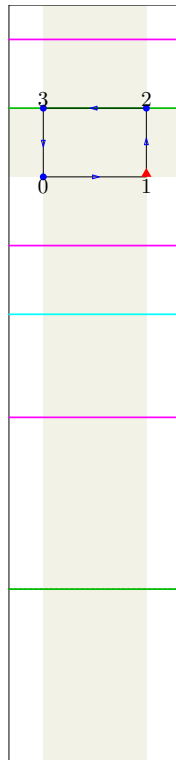

```

encode("dotaccent")(6); standard_introduce("dotaccent");
beginglyph(dotaccent);
 $y_0 = y_1 = lc\_height + 2xu;$   $x_0 = x_3 = leftstemloc;$ 
 $x_2 - x_3 = x_1 - x_0 = px;$   $y_3 - y_0 = y_2 - y_1 = py;$ 
Fill  $z_0$  --  $z_1$  --  $z_2$  --  $z_3$  -- cycle;
fix_vstem( $px$ )(glyph_stored.glyph_name 1);
fix_hstem( $py$ )(glyph_stored.glyph_name 1);
fix_dimens( $x_1 + rightbear$ ,  $y_2$ , 0, 0);
just_labels bot(0, 1);
just_labels top(2, 3);
standard_exact_hsbw("dotaccent");
endglyph;

```

Construction of the character ring:

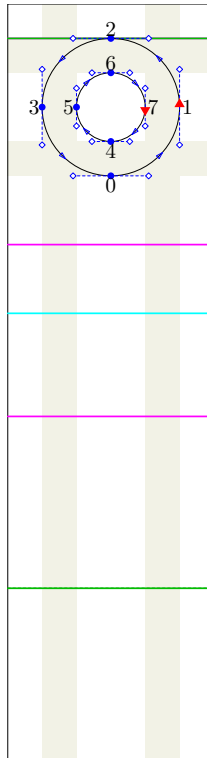

```

encode("ring")(8); standard_introduce("ring");
beginglyph(ring);
x3 = leftstemloc;
x1 - x3 = y2 - y0 = 4xu; x2 = x0 = x6 = x4 = .5[x3, x1] = .5[x5, x7];
x7 - x5 = y6 - y4 = 2xu; y3 = y5 = y7 = y1 = .5[y0, y2] = .5[y4, y6];
y0 = lc_height + 2xu;

Fill z0 .. z1 .. z2 .. z3 .. cycle;
unFill z4 .. z5 .. z6 .. z7 .. cycle;

fix_hstem(y4 - y0)(glyph_stored.glyph_name 1, glyph_stored.glyph_name 2);
fix_vstem(x5 - x3)(glyph_stored.glyph_name 1, glyph_stored.glyph_name 2);
fix_dimens(x1 + rightbear, y2, 0, 0);

just_labels bot(0, 4);
just_labels top(2, 6);
just_labels lft(3, 5);
just_labels rt(1, 7);

standard_exact_hsbw("ring");
endglyph;

```

Construction of the character hungarumlaut:

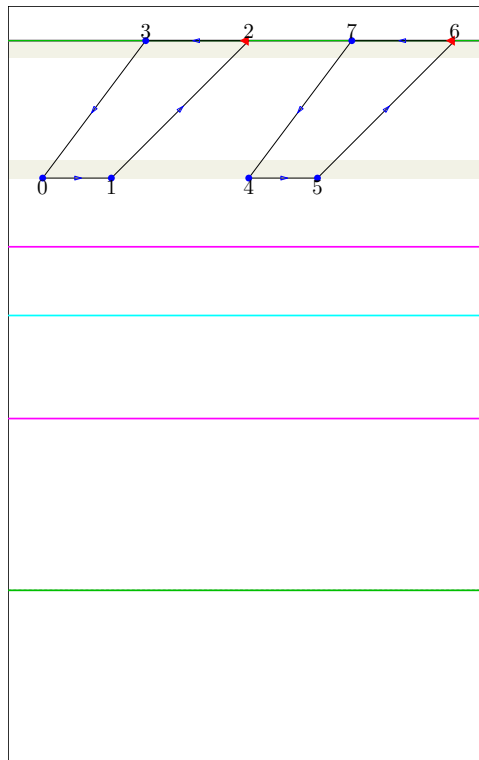

```

encode("hungarumlaut")(10); standard_introduce("hungarumlaut");
begin_glyph(hungarumlaut);
 $x_0 = \text{leftstemloc}; x_4 = x_2;$ 
 $x_2 - x_3 = x_6 - x_7 = px = x_1 - x_0 + xu = x_5 - x_4 + xu; y_3 - y_0 = y_2 - y_1 = y_7 - y_4 = y_6 - y_5 = 4xu;$ 
 $x_3 - x_0 = x_7 - x_4 = 3xu;$ 
 $y_0 = y_1 = y_4 = y_5 = lc\_height + 2xu;$ 
Fill  $z_0 \text{ -- } z_1 \text{ -- } z_2 \text{ -- } z_3 \text{ -- cycle}, z_4 \text{ -- } z_5 \text{ -- } z_6 \text{ -- } z_7 \text{ -- cycle};$ 
ghost_stem top, bot;
fix_dimens( $x_6 + \text{rightbear}, y_6, 0, 0$ );
just_labels bot(0, 1, 4, 5);
just_labels top(2, 3, 6, 7);
standard_exact_hsbw("hungarumlaut");
end_glyph;

```

Construction of the character ogonek:

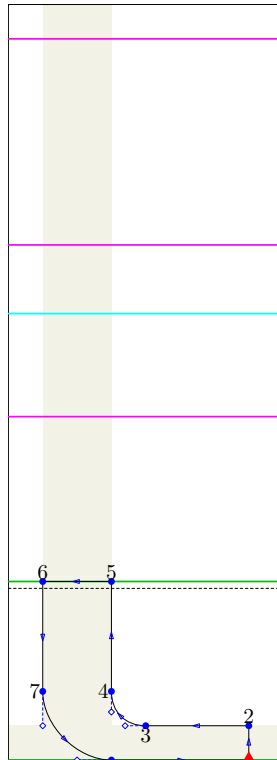

```
encode("ogonek")(11); standard_introduce("ogonek");
beginglyph(ogonek);
```

```
 $y_0 = y_1 = \text{descender}; x_6 = x_7 = \text{leftstemloc}; y_5 = y_6 = u;$ 
 $x_5 - x_6 = x_4 - x_7 = 2xu; x_2 - x_3 = 3xu; x_1 = x_2;$ 
 $y_3 - y_0 = y_2 - y_1 = xu;$ 
 $z_4 = z_3 + (-.5ibow, .5ibow); z_0 = z_7 + (.5obow, -.5obow);$ 
```

```
Fill  $z_0$  --  $z_1$  --  $z_2$  -- small_bow left(3, 4) --  $z_5$  --  $z_6$  -- med_crescent down(7, 0) & cycle;
```

```
fix_vstem(2xu)(glyph_stored.glyph_name 1);
fix_hstem(xu)(glyph_stored.glyph_name 1);
fix_dimens( $x_1 + \text{rightbear}$ ,  $y_5$ ,  $y_0$ , 0);
```

```
just_labels bot(0, 1, 3);
just_labels top(2, 5, 6);
just_labels lft(4, 7);
```

```
standard_exact_hsbw("ogonek");
endglyph;
```

Construction of the character caron:

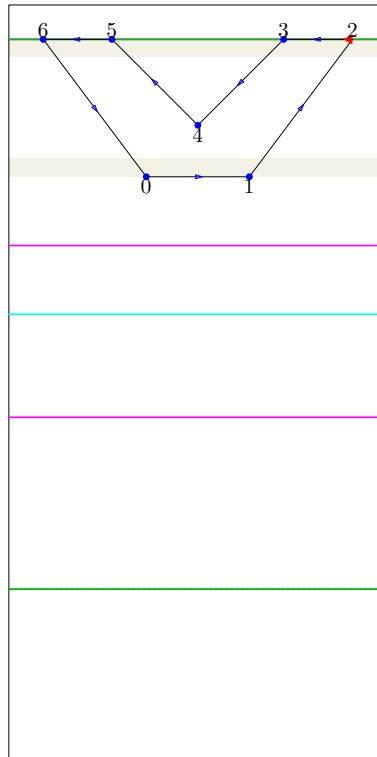

```

encode("caron")(12); standard_introduce("caron");
begin_glyph(caron);
 $x_6 = \text{leftstemloc}$ ;
 $x_1 - x_0 = px = x_5 - x_6 + xu = x_2 - x_3 + xu$ ;  $y_6 - y_0 = y_2 - y_1 = 4xu$ ;  $y_5 = y_6$ ;  $y_3 = y_2$ ;
 $x_0 - x_6 = x_2 - x_1 = 3xu$ ;
 $y_0 = y_1 = \text{lc.height} + 2xu$ ;
 $z_4 = \text{whatever}[z_0, z_3] = \text{whatever}[z_1, z_5]$ ;

Fill  $z_0$  --  $z_1$  --  $z_2$  --  $z_3$  --  $z_4$  --  $z_5$  --  $z_6$  -- cycle;

ghost_stem top, bot;
fix_dimens( $x_2 + \text{rightbear}$ ,  $y_2$ , 0, 0);

just_labels bot(0, 1, 4);
just_labels top(2, 3, 5, 6);

standard_exact_hsbw("caron");
end_glyph;

```

Construction of the character dotlessi:

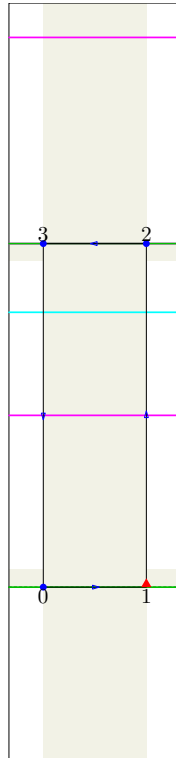

```

encode("dotlessi")(13); standard_introduce("dotlessi");
begin_glyph(dotlessi);
 $y_0 = y_1 = 0$ ;  $x_0 = x_3 = \textit{leftstemloc}$ ;  $y_2 = y_3 = \textit{lc\_height}$ ;
 $x_2 - x_3 = x_1 - x_0 = \textit{px}$ ;
Fill  $z_0$  --  $z_1$  --  $z_2$  --  $z_3$  -- cycle;
fix_vstem( $\textit{px}$ )(glyph_stored.glyph_name 1);
ghost_stem bot, top;
fix_dimens( $x_1 + \textit{rightbear}$ ,  $y_2$ , 0, 0);
just_labels bot(0, 1);
just_labels top(2, 3);
standard_exact_hsbw("dotlessi");
end_glyph;

```

Construction of the character fraction:

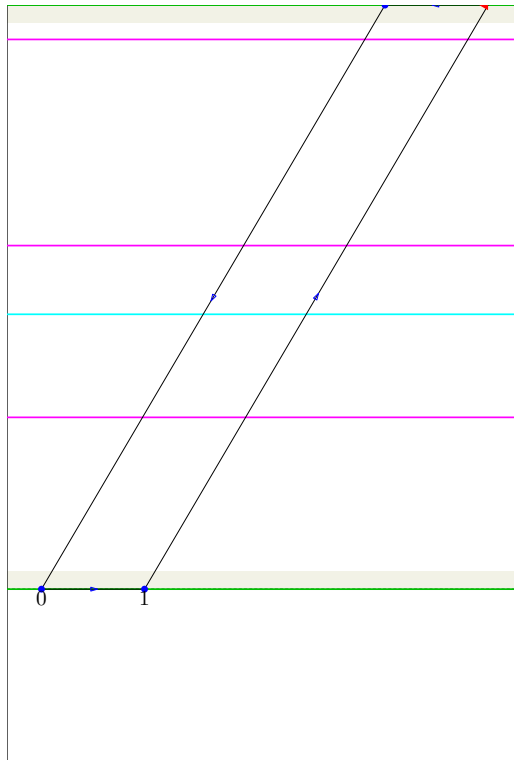

```

encode("fraction")(25); standard_introduce("fraction");
beginglyph(fraction);
 $y_0 = y_1 = 0$ ;  $x_0 = \textit{leftstemloc}$ ;  $y_2 = y_3 = \textit{ascender}$ ;
 $x_1 - x_0 = x_2 - x_3 = \textit{px}$ ;  $x_3 - x_1 = 7\textit{xu}$ ;
Fill  $z_0$  --  $z_1$  --  $z_2$  --  $z_3$  -- cycle;
ghost_stem bot, top;
fix_dimens( $x_2 + \textit{rightbear}$ ,  $y_2$ , 0, 0);
just_labels bot(0, 1);
just_labels top(2, 3);
standard_exact_hsbw("fraction");
endglyph;

```

Construction of the character fi:

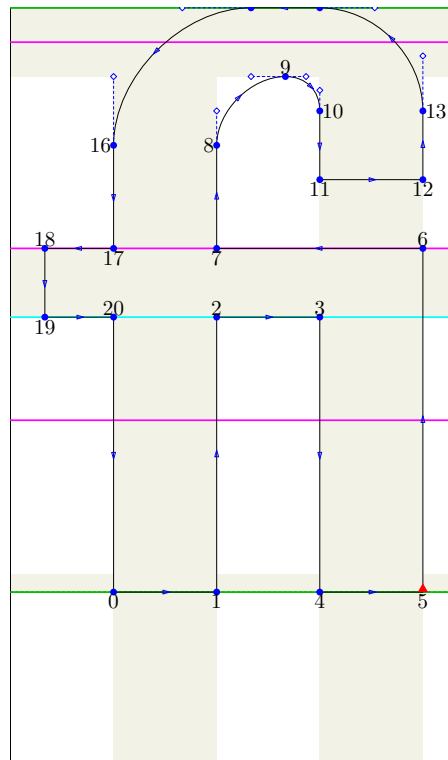

```
encode("fi")(26); standard_introduce("fi");
beginlyph(fi);
```

```
y0 = y1 = y4 = y5 = 0; x18 = x19 = leftstemloc; y14 = y15 = ascender;
x1 - x0 = x2 - x20 = x7 - x17 = x8 - x16 = x13 - x10
= x12 - x11 = x6 - x3 = x5 - x4 = px; x3 = x4 = x11 = x10; x17 - x18 = x20 - x19 = 2xu; x16 = x17; x20 = x0;
y6 = y7 = y17 = y18 = lc_height; y15 - y9 = y18 - y19 = y17 - y20 = y7 - y2 = y6 - y3 = py;
y10 - y11 = 2xu; y12 = y11;
hv0 := x2; hv1 := x3; hh0 := y6; hh1 := y12;
z9 = z8 + (ibow, ibow); z10 = z9 + (.5ibow, -.5ibow); z14 = z13 + (-.75obow, .75obow);
z16 = z15 - (obow, obow);
```

```
Fill z0 -- z1 -- z2 -- z3 -- z4 -- z5 -- z6 -- z7 -- bow up(8, 9) & small_bow right(9, 10) -- z11
-- z12 -- small_crescent up(13, 14) -- crescent left(15, 16) -- z17 -- z18 -- z19
-- z20 -- cycle;
```

```
fix_vstem(px)(glyph_stored.glyph_name 1)(x <= hv0);
fix_vstem(px)(glyph_stored.glyph_name 1)(x >= hv1);
fix_hstem(py)(glyph_stored.glyph_name 1)((y <= hh0) or (y > hh1));
ghost_stem bot;
fix_dimens(x5 + rightbear, y14, 0, 0);

just_labels bot(0, 1, 4, 5, 7, 11, 12, 17, 19);
just_labels top(2, 3, 6, 9, 14, 15, 18, 20);
just_labels rt(10, 13);
just_labels lft(8, 16);
```

```
standard_exact_hsbw("fi");
endglyph;
```

Construction of the character fl:

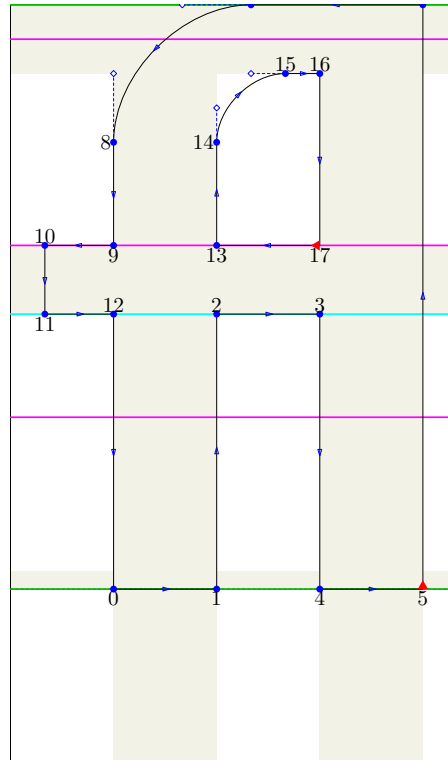

```

encode("fl")(27); standard_introduce("fl");
beginglyph(fl);
 $y_0 = y_1 = y_4 = y_5 = 0; x_{10} = x_{11} = \text{leftstemloc}; y_6 = y_7 = \text{ascender};$ 
 $x_1 - x_0 = x_2 - x_{12} = x_{13} - x_9 = x_{14} - x_8 = x_6 - x_{16}$ 
 $= x_6 - x_{17} = x_5 - x_4 = px; x_9 - x_{10} = x_{12} - x_{11} = 2xu; x_{16} - x_{15} = xu;$ 
 $x_3 = x_4 = x_{17}; x_8 = x_9; x_{12} = x_0; y_{17} - y_3 = y_{13} - y_2 = y_9 - y_{12} = y_{10} - y_{11}$ 
 $= y_6 - y_{16} = y_7 - y_{15} = py; y_9 = y_{10} = y_{13} = y_{17} = \text{lc\_height};$ 
 $z_8 = z_7 - (\text{obow}, \text{obow}); z_{15} = z_{14} + (\text{ibow}, \text{ibow});$ 
 $hv_0 := x_1; hv_1 := x_4;$ 

Fill  $z_0$  --  $z_1$  --  $z_2$  --  $z_3$  --  $z_4$  --  $z_5$  --  $z_6$  -- crescent left(7, 8) --  $z_9$  --  $z_{10}$  --  $z_{11}$ 
--  $z_{12}$  -- cycle;
unFill  $z_{13}$  -- bow up(14, 15) --  $z_{16}$  --  $z_{17}$  -- cycle;

fix_vstem( $px$ )(glyph_stored.glyph_name 1, glyph_stored.glyph_name 2)( $x \leq hv_0$ );
fix_vstem( $px$ )(glyph_stored.glyph_name 1, glyph_stored.glyph_name 2)( $x \geq hv_1$ );
fix_hstem( $py$ )(glyph_stored.glyph_name 1, glyph_stored.glyph_name 2);
fix_dimens( $x_5 + \text{rightbear}$ ,  $y_6$ , 0, 0);
ghost_stem bot;

just_labels bot(0, 1, 4, 5, 9, 11, 13, 17);
just_labels top(2, 3, 6, 7, 10, 12, 15, 16);
just_labels lft(8, 14);

standard_exact_hsbw("fl");
endglyph;

```

Construction of the character ffi:

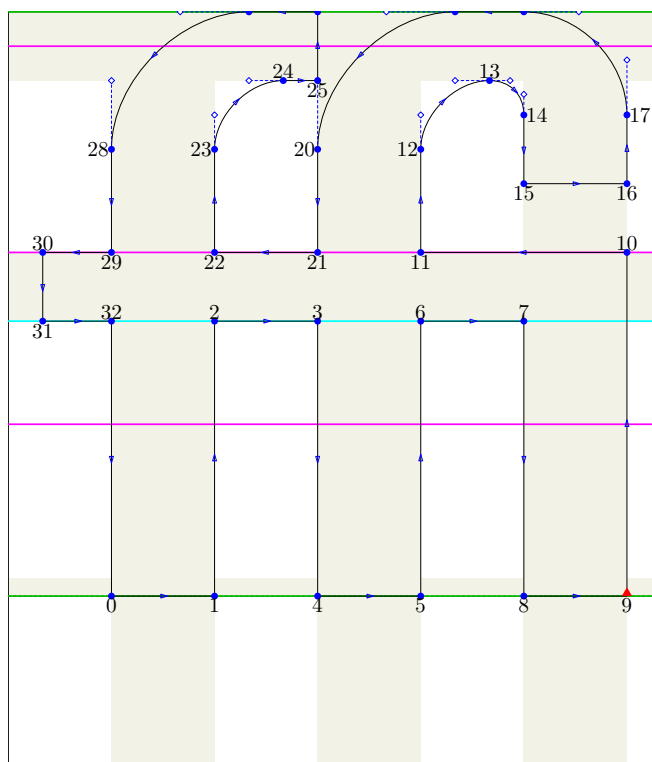

```

encode("ffi")(20); standard_introduce("ffi");
beginlyph(ffi);
y0 = y1 = y4 = y5 = y8 = y9 = 0; x30 = x31 = leftstemloc; y18 = y19 = y26 = y27 = ascender;
x1 - x0 = x2 - x32 = x22 - x29 = x23 - x28 = x5 - x4 = x6 - x3
= x11 - x21 = x12 - x20 = x17 - x14 = x16 - x15 = x10 - x7
= x9 - x8 = px; x32 - x31 = x29 - x30 = 2xu; x32 = x0; x28 = x29; x8 = x7 = x15 = x14;
x4 - x1 = x8 - x5; x3 - x2 = x7 - x6; x15 - x11 = x21 - x22; x14 - x12 = x20 - x23; x25 = x26 = x20;
y26 - y25 = y27 - y24 = y18 - y13 = y30 - y31 = y29 - y32
= y22 - y2 = y21 - y3 = y11 - y6 = y10 - y7 = py; y30 = y29 = y22 = y21 = y11 = y10 = lc_height;
y14 - y15 = 2xu; y16 = y15;
z13 = z12 + (ibow, ibow); z14 = z13 + (.5ibow, -.5ibow); z18 = z17 + (-.75obow, .75obow);
z20 = z19 - (obow, obow); z24 = z23 + (ibow, ibow); z28 = z27 - (obow, obow);
hv0 := x1; hv1 := x8; hh0 := y10; hh1 := y15;

Fill z0 -- z1 -- z2 -- z3 -- z4 -- z5 -- z6 -- z7 -- z8 -- z9 -- z10 -- z11 -- bow up(12, 13)
  & small_bow right(13, 14) -- z15 -- z16 -- small_crescent up(17, 18)
  -- crescent left(19, 20) -- z21 -- z22 -- bow up(23, 24) -- z25 -- z26
  -- crescent left(27, 28) -- z29 -- z30 -- z31 -- z32 -- cycle;

fix_vstem(px)(glyph_stored.glyph_name 1)((x <= hv0) or (x >= hv1));
fix_vstem(px)(glyph_stored.glyph_name 1)((x > hv0) and (x < hv1));
fix_hstem(py)(glyph_stored.glyph_name 1)((y <= hh0) or (y > hh1));
fix_dimens(x9 + rightbear, y18, 0, 0);
ghost_stem bot;

just_labels bot(0, 1, 4, 5, 8, 9, 11, 15, 16, 21, 22, 25, 29, 31);
just_labels top(2, 3, 6, 7, 10, 13, 18, 19, 24, 26, 27, 30, 32);
just_labels lft(12, 20, 23, 28);
just_labels rt(14, 17);

standard_exact_hsbw("ffi");
endglyph;

```

Construction of the character ffl:

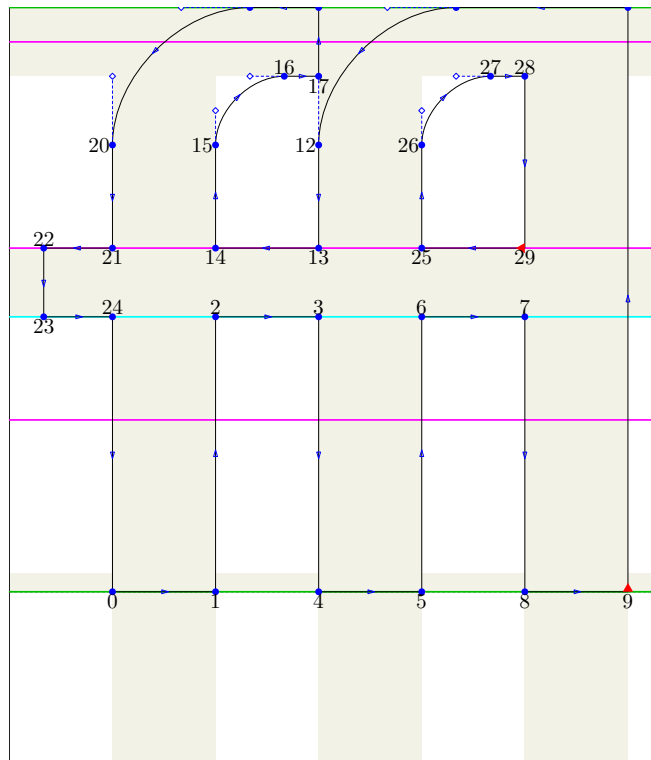

```

encode("ffl")(21); standard_introduce("ffl");
beginglyph(ffl);
 $y_0 = y_1 = y_4 = y_5 = y_8 = y_9 = 0$ ;  $x_{22} = x_{23} = \text{leftstemloc}$ ;  $y_{10} = y_{11} = y_{18} = y_{19} = \text{ascender}$ ;
 $x_1 - x_0 = x_2 - x_{24} = x_{14} - x_{21} = x_{15} - x_{20} = x_5 - x_4 = x_6 - x_3$ 
 $= x_{25} - x_{13} = x_{26} - x_{12} = x_9 - x_8 = x_{10} - x_{28} = px$ ;  $x_{28} - x_{27} = xu$ ;  $x_{20} = x_{21}$ ;  $x_0 = x_{24}$ ;
 $x_7 = x_{29} = x_8$ ;  $x_9 = x_{10}$ ;  $x_8 - x_5 = x_4 - x_1$ ;  $x_7 - x_6 = x_3 - x_2$ ;  $x_{29} - x_{25} = x_{13} - x_{14}$ ;
 $x_{28} - x_{26} = x_{12} - x_{15}$ ;  $x_{17} = x_{12}$ ;  $x_{21} - x_{22} = x_{24} - x_{23} = 2xu$ ;  $x_{18} = x_{17}$ ;
 $y_{22} - y_{23} = y_{21} - y_{24} = y_{14} - y_2 = y_{13} - y_3 = y_{25} - y_6$ 
 $= y_{29} - y_7 = y_{19} - y_{16} = y_{18} - y_{17} = y_{11} - y_{27} = y_{10} - y_{28} = py$ ;
 $y_{13} = y_{14} = y_{21} = y_{22} = y_{25} = y_{29} = \text{lc\_height}$ ;
 $z_{12} = z_{11} - (\text{obow}, \text{obow})$ ;  $z_{16} = z_{15} + (\text{ibow}, \text{ibow})$ ;  $z_{20} = z_{19} - (\text{obow}, \text{obow})$ ;
 $z_{27} = z_{26} + (\text{ibow}, \text{ibow})$ ;
 $hv_0 := x_2$ ;  $hv_1 := x_7$ ;

Fill  $z_0$  --  $z_1$  --  $z_2$  --  $z_3$  --  $z_4$  --  $z_5$  --  $z_6$  --  $z_7$  --  $z_8$  --  $z_9$  --  $z_{10}$ 
  -- crested left(11, 12) --  $z_{13}$  --  $z_{14}$  -- bow up(15, 16) --  $z_{17}$  --  $z_{18}$ 
  -- crested left(19, 20) --  $z_{21}$  --  $z_{22}$  --  $z_{23}$  --  $z_{24}$  -- cycle;
unFill  $z_{25}$  -- bow up(26, 27) --  $z_{28}$  --  $z_{29}$  -- cycle;

fix_vstem( $px$ )(glyph_stored.glyph_name 1,
  glyph_stored.glyph_name 2)(( $x \leq hv_0$ ) or ( $x \geq hv_1$ ));
fix_vstem( $px$ )(glyph_stored.glyph_name 1,
  glyph_stored.glyph_name 2)(( $x > hv_0$ ) and ( $x < hv_1$ ));
fix_hstem( $py$ )(glyph_stored.glyph_name 1, glyph_stored.glyph_name 2);
fix_dimens( $x_9 + \text{rightbear}$ ,  $y_{10}$ , 0, 0);
ghost_stem bot;

just_labels bot(0, 1, 4, 5, 8, 9, 13, 14, 17, 21, 23, 25, 29);
just_labels top(2, 3, 6, 7, 10, 11, 16, 18, 19, 22, 24, 27, 28);
just_labels lft(12, 15, 20, 26);

standard_exact_hsbw("ffl");
endglyph;

```

Construction of the character ff:

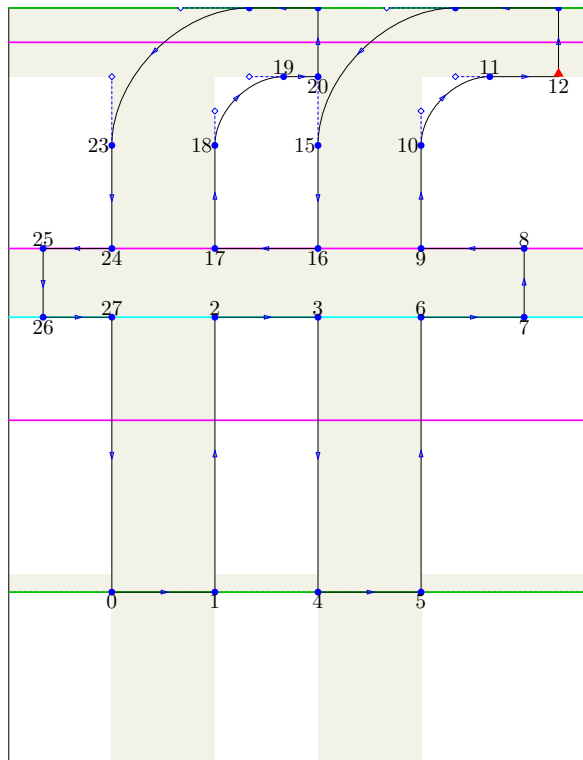

```
encode("ff")(19); standard_introduce("ff");
beginlyph(ff);
```

```
y0 = y1 = y4 = y5 = 0; x25 = x26 = leftstemloc; y13 = y14 = y21 = y22 = ascender;
x1 - x0 = x2 - x27 = x17 - x24 = x18 - x23 = x5 - x4
= x6 - x3 = x9 - x16 = x10 - x15 = px; x27 - x26 = x24 - x25 = 2xu; x20 - x19 = xu;
x12 - x11 = 2xu; x8 - x9 = x7 - x6 = 3xu; x0 = x27; x23 = x24; x4 - x1 = x3 - x2
= x16 - x17 = x15 - x18 = x20 - x18; x21 = x20; x13 = x12;
y25 - y26 = y24 - y27 = y17 - y2 = y16 - y3 = y9 - y6
= y8 - y7 = y22 - y19 = y21 - y20 = y14 - y11 = y13 - y12 = py; y8 = y9 = y16 = y17 = y24 = y25 = lc_height;
z11 = z10 + (ibow, ibow); z15 = z14 - (obow, obow); z19 = z18 + (ibow, ibow);
z23 = z22 - (obow, obow);
hv0 := x2; hv1 := x6;
```

```
Fill z0 -- z1 -- z2 -- z3 -- z4 -- z5 -- z6 -- z7 -- z8 -- z9 -- bow up(10, 11) -- z12 -- z13
-- crescent left(14, 15) -- z16 -- z17 -- bow up(18, 19) -- z20 -- z21
-- crescent left(22, 23) -- z24 -- z25 -- z26 -- z27 -- cycle;
```

```
fix_vstem(px)(glyph_stored.glyph_name 1)(x <= hv0);
fix_vstem(px)(glyph_stored.glyph_name 1)((x > hv0) and (x <= hv1));
fix_hstem(py)(glyph_stored.glyph_name 1);
fix_dimens(x12 + rightbear, y13, 0, 0);
ghost_stem bot;
```

```
just_labels bot(0, 1, 4, 5, 7, 9, 12, 16, 17, 20, 24, 26);
just_labels top(2, 3, 6, 8, 11, 13, 14, 19, 21, 22, 25, 27);
just_labels lft(10, 15, 18, 23);
```

```
standard_exact_hsbw("ff");
endglyph;
```

Construction of the character space:

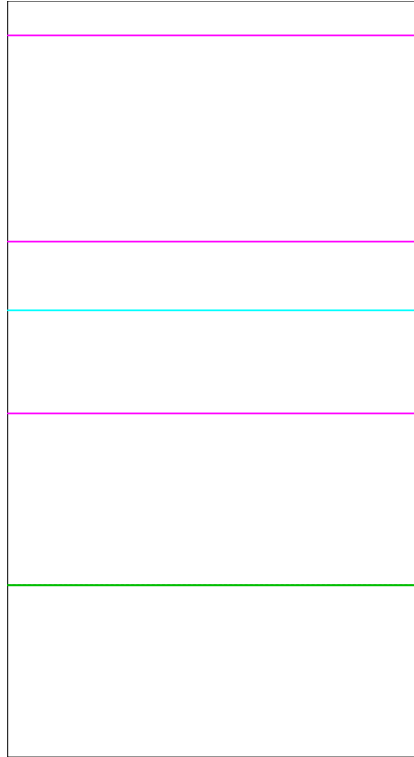

```
encode("space")(32); standard_introduce("space");
beginlyph(space);
fix_dimens(space, 0, 0, 0);
standard_exact_hsbw("space");
endglyph;
```

Construction of the character exclam:

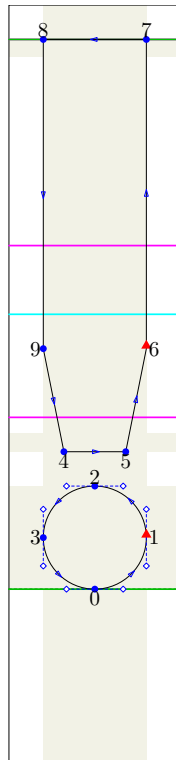

```

encode("exclam")(33); standard_introduce("exclam");
beginlyph(exclam);
y0 = 0; x3 = x8 = x9 = leftstemloc; y8 = y7 = uc_height;
x7 - x8 = x6 - x9 = px = x1 - x3 = y2 - y0; x2 = x0 = .5[x3, x1]; y1 = y3 = .5[y2, y0];
y4 - y2 = y5 - y2 = xu; x4 - x9 = x6 - x5 = 3u; y9 = y6 = .5uc_height - .5py; %y8-y9=y7-y6=7xu;

Fill z0 .. z1 .. z2 .. z3 .. cycle, z4 -- z5 -- z6 -- z7 -- z8 -- z9 -- cycle;

fix_vstem(px)(glyph_stored.glyph_name 1, glyph_stored.glyph_name 2);
fix_hstem(px)(glyph_stored.glyph_name 1, glyph_stored.glyph_name 2);
fix_dimens(x1 + rightbear, y7, 0, 0);
ghost_stem bot(y4), top;

just_labels bot(0, 4, 5);
just_labels top(2, 8, 7);
just_labels rt(1, 6);
just_labels lt(3, 9);

standard_exact_hsbw("exclam");
endglyph;

```

Construction of the character `quotedbl`:

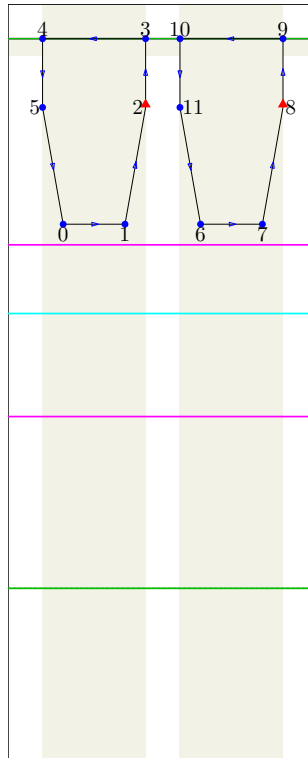

```
encode("quotedbl")(34); standard_introduce("quotedbl");
beginlyph(quotedbl);
```

```
 $x_4 = x_5 = \text{leftstemloc}; y_3 = y_4 = y_9 = y_{10} = \text{uc\_height};$ 
 $y_4 - y_5 = y_3 - y_2 = y_{10} - y_{11} = y_9 - y_8 = 2xu;$ 
 $y_5 - y_0 = y_2 - y_1 = y_{11} - y_6 = y_8 - y_7 = 3xu + 2u;$ 
 $x_0 - x_5 = x_2 - x_1 = x_6 - x_{11} = x_8 - x_7 = 3u;$ 
 $x_2 - x_5 = x_3 - x_4 = x_8 - x_{11} = x_9 - x_{10} = px;$ 
 $x_{10} = x_{11} = x_3 + xu;$ 
```

```
Fill  $z_0$  --  $z_1$  --  $z_2$  --  $z_3$  --  $z_4$  --  $z_5$  -- cycle,  $z_6$  --  $z_7$  --  $z_8$  --  $z_9$  --  $z_{10}$  --  $z_{11}$  -- cycle;
```

```
fix_vstem(px)(glyph_stored.glyph_name 1, glyph_stored.glyph_name 2);
```

```
ghost_stem top;
```

```
fix_dimens( $x_8 + \text{rightbear}$ ,  $y_9$ , 0, 0);
```

```
just_labels bot(0, 1, 6, 7);
```

```
just_labels top(3, 4, 9, 10);
```

```
just_labels rt(11, 8);
```

```
just_labels lft(2, 5);
```

```
standard_exact_hsbw("quotedbl");
```

```
endglyph;
```

Construction of the character numbersign:

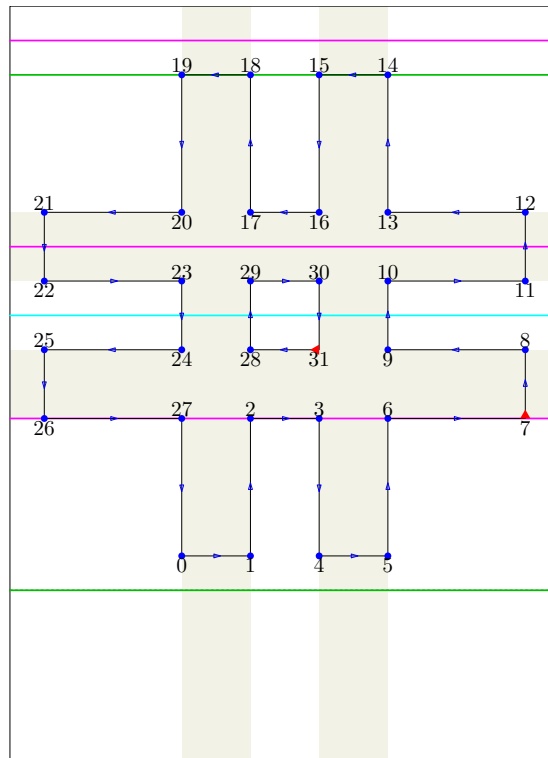

```

encode("numbersign")(35); standard_introduce("numbersign");
beginglyph(numbersign);
y0 = y1 = y4 = y5 = xu; x21 = x22 = x25 = x26 = leftstemloc; y14 = y15 = y18 = y19 = uc_height - xu;
x12 - x21 = x11 - x22 = x8 - x25 = x7 - x26 = y19 - y0;
x18 - x19 = x17 - x20 = x29 - x23 = x28 - x24 = x2 - x27
= x1 - x0 = x14 - x15 = x13 - x16 = x10 - x30 = x9 - x31
= x6 - x3 = x5 - x4 = py = y21 - y22 = y20 - y23 = y17 - y29
= y16 - y30 = y13 - y10 = y12 - y11 = y25 - y26 = y24 - y27
= y28 - y2 = y31 - y3 = y9 - y6 = y8 - y7;
x0 = x19 = x20 = x23 = x24 = x27; x3 = x4 = x15 = x16 = x30 = x31;
y12 = y13 = y16 = y17 = y20 = y21; y8 = y9 = y24 = y25 = y28 = y31;
hv0 := x1; hv1 := x4; hh0 := y8; hh1 := y11;

.5[x2, x3] = .5[x26, x7]; .5[y23, y24] = .5[y0, y19]; x3 - x2 = y23 - y24 = 2xu;

Fill z0 -- z1 -- z2 -- z3 -- z4 -- z5 -- z6 -- z7 -- z8 -- z9 -- z10 -- z11
-- z12 -- z13 -- z14 -- z15 -- z16 -- z17 -- z18 -- z19 -- z20 -- z21 -- z22
-- z23 -- z24 -- z25 -- z26 -- z27 -- cycle;
unFill z28 -- z29 -- z30 -- z31 -- cycle;

fix_vstem(py)(glyph_stored.glyph_name 1, glyph_stored.glyph_name 2)(x <= hv0);
fix_vstem(py)(glyph_stored.glyph_name 1, glyph_stored.glyph_name 2)(x >= hv1);
fix_hstem(py)(glyph_stored.glyph_name 1, glyph_stored.glyph_name 2)(y <= hh0);
fix_hstem(py)(glyph_stored.glyph_name 1, glyph_stored.glyph_name 2)(y >= hh1);
fix_dimens(x7 + rightbear, y14, 0, 0);

just_labels bot(0, 1, 4, 5, 7, 9, 11, 13, 16, 17, 20, 22, 24, 26, 28, 31);
just_labels top(2, 3, 6, 8, 10, 12, 14, 15, 18, 19, 21, 23, 25, 27, 29, 30);

standard_exact_hsbw("numbersign");
endglyph;

```

Construction of the character dollar:

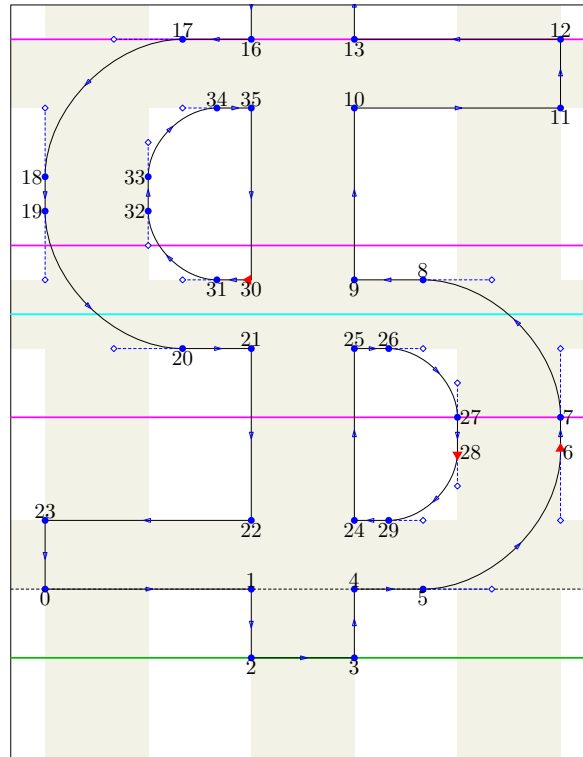

```
encode("dollar")(36); standard_introduce("dollar");
beginlyph(dollar);
```

```
 $y_0 = y_1 = y_4 = y_5 = 0$ ;  $x_0 = x_{18} = x_{19} = x_{23} = \text{leftstemloc}$ ;  $y_{12} = y_{13} = y_{16} = y_{17} = \text{uc.height}$ ;
```

```
 $x_{33} - x_{18} = x_{32} - x_{19} = x_7 - x_{27} = x_6 - x_{28}$ 
```

```
 $= x_3 - x_2 = x_4 - x_1 = x_9 - x_{30} = x_{10} - x_{35}$ 
```

```
 $= x_{13} - x_{16} = x_{14} - x_{15} = x_{24} - x_{22} = x_{25} - x_{21} = px$ ;
```

```
 $x_{26} - x_{31} = 5xu$ ;  $x_6 = x_7 = x_{11} = x_{12}$ ;
```

```
 $y_{13} - y_{10} = y_{12} - y_{11} = y_{17} - y_{34} = y_{16} - y_{35}$ 
```

```
 $= y_8 - y_{26} = y_9 - y_{25} = y_{30} - y_{21} = y_{31} - y_{20}$ 
```

```
 $= y_{22} - y_1 = y_{23} - y_0 = y_{24} - y_4 = y_{29} - y_5 = py$ ;
```

```
 $.5[y_{20}, y_{31}] = .5[y_{21}, y_{30}] = .5[y_{25}, y_9]$ 
```

```
 $= .5[y_{26}, y_8] = .5\text{uc.height}$ ;
```

```
 $y_1 - y_2 = y_4 - y_3 = y_{15} - y_{16} = y_{14} - y_{13} = 2xu$ ;
```

```
 $z_6 = z_5 + (\text{obow}, \text{obow})$ ;  $z_8 = z_7 + (-\text{obow}, \text{obow})$ ;
```

```
 $z_{32} = z_{31} + (-\text{ibow}, \text{ibow})$ ;  $z_{34} = z_{33} + (\text{ibow}, \text{ibow})$ ;
```

```
 $z_{18} = z_{17} - (\text{obow}, \text{obow})$ ;  $z_{20} = z_{19} + (\text{obow}, -\text{obow})$ ;
```

```
 $z_{27} = z_{26} + (\text{ibow}, -\text{ibow})$ ;  $z_{29} = z_{28} - (\text{ibow}, \text{ibow})$ ;
```

```
 $.5[x_1, x_4] = .5[x_2, x_3] = .5[x_{15}, x_{14}] = .5[x_{16}, x_{13}]$ 
```

```
 $= .5[x_{21}, x_{25}] = .5[x_{22}, x_{24}] = .5[x_{30}, x_9] = .5[x_{35}, x_{10}]$ 
```

```
 $= .5[x_{31}, x_{26}]$ ;
```

```
 $hv_0 := x_{32}$ ;  $hv_1 := x_{30}$ ;  $hv_2 := x_{25}$ ;  $hv_3 := x_{27}$ ;  $hh_0 := y_2$ ;  $hh_1 := y_{14}$ ;
```

```

Fill  $z_0$  --  $z_1$  --  $z_2$  --  $z_3$  --  $z_4$  -- crescent right(5, 6) -- crescent up(7, 8)
  --  $z_9$  --  $z_{10}$  --  $z_{11}$  --  $z_{12}$  --  $z_{13}$  --  $z_{14}$  --  $z_{15}$  --  $z_{16}$  -- crescent left(17, 18)
  -- crescent down(19, 20) --  $z_{21}$  --  $z_{22}$  --  $z_{23}$  -- cycle;
unFill  $z_{24}$  --  $z_{25}$  -- bow right(26, 27) -- bow down(28, 29) -- cycle,
   $z_{30}$  -- bow left(31, 32) -- bow up(33, 34) --  $z_{35}$  -- cycle;

fix_vstem( $px$ )(glyph_stored.glyph_name 1, glyph_stored.glyph_name 2,
  glyph_stored.glyph_name 3)( $x \leq hv_0$ );
fix_vstem( $px$ )(glyph_stored.glyph_name 1, glyph_stored.glyph_name 2,
  glyph_stored.glyph_name 3)(( $x \geq hv_1$ ) and ( $x \leq hv_2$ ));
fix_vstem( $px$ )(glyph_stored.glyph_name 1, glyph_stored.glyph_name 2,
  glyph_stored.glyph_name 3)( $x \geq hv_3$ );
fix_hstem( $py$ )(glyph_stored.glyph_name 1, glyph_stored.glyph_name 2,
  glyph_stored.glyph_name 3)(( $y > hh_0$ ) and ( $y < hh_1$ ));
fix_dimens( $x_6 + rightbear$ ,  $y_{14}$ ,  $y_2$ , 0);

just_labels bot(0, 2, 3, 5, 9, 11, 13, 16, 20, 22, 24, 29, 30, 31);
just_labels top(1, 4, 8, 10, 12, 14, 15, 17, 21, 23, 25, 26, 34, 35);
just_labels lft(18, 19, 32, 33);
just_labels rt(6, 7, 27, 28);

vstem_triple := true;

standard_exact_hsbw("dollar");
endglyph;

```

Construction of the character zerosuperior:

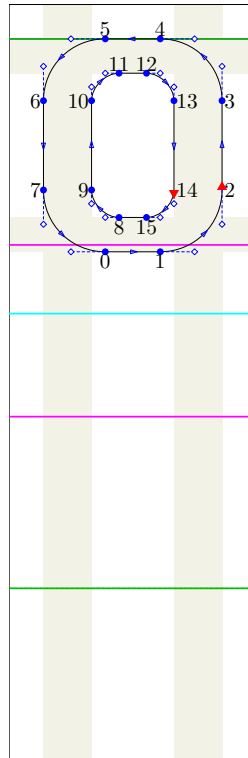

```

standard_introduce("zerosuperior");
beginglyph(zerosuperior);
y0 = y1 = lc_height - u; x6 = x7 = leftstemloc; y4 = y5 = uc_height;
x10 - x6 = x9 - x7 = x3 - x13 = x2 - x14 = .5(px - u);
x12 - x11 = x15 - x8 = 4u;
y8 - y0 = y15 - y1 = y5 - y11 = y4 - y12 = .5py;
z2 = z1 + (.45obow, .45obow); z4 = z3 + (-.45obow, .45obow); z6 = z5 - (.45obow, .45obow);
z0 = z7 + (.45obow, -.45obow);
z9 = z8 + (-.4ibow, .4ibow); z11 = z10 + (.4ibow, .4ibow); z13 = z12 + (.4ibow, -.4ibow);
z15 = z14 - (.4ibow, .4ibow);

Fill z0 -- med_crescent right(1, 2) -- med_crescent up(3, 4) -- med_crescent left(5, 6)
  -- med_crescent down(7, 0) & cycle;
unFill mini_bow left(8, 9) -- mini_bow up(10, 11) -- mini_bow right(12, 13)
  -- mini_bow down(14, 15) -- cycle;

fix_hstem(.5py)(glyph_stored.glyph_name 1, glyph_stored.glyph_name 2);
fix_vstem(.5(px - u))(glyph_stored.glyph_name 1, glyph_stored.glyph_name 2);
fix_dimens(round(x2 + rightbear), y4, 0, 0);

just_labels bot(0, 1, 8, 15);
just_labels top(4, 5, 11, 12);
just_labels rt(2, 3, 13, 14);
just_labels lft(6, 7, 9, 10);

standard_exact_hsbw("zerosuperior");
endglyph;

```

Construction of the character percent:

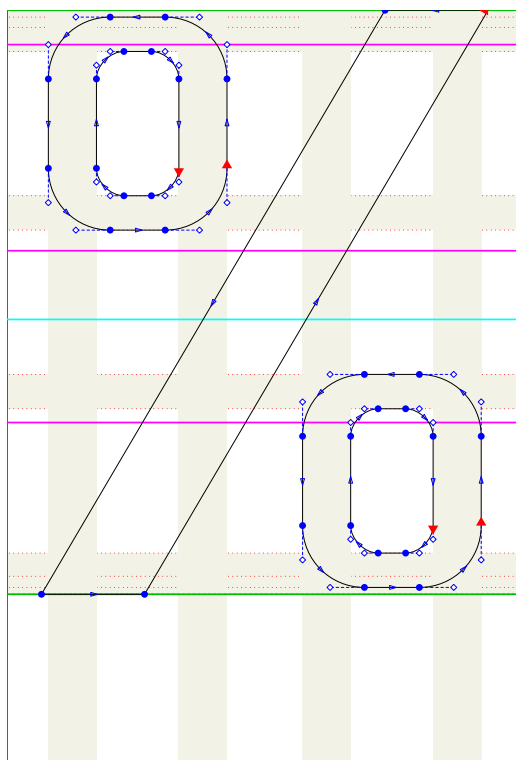

```

encode("percent")(37); standard_introduce("percent");
beginglyph(percent);
use_glyph(fraction);
use_glyph(zerosuperior)(u, ascender - uc_height - u);
use_glyph(zerosuperior)(wd.fraction - wd.zerosuperior - u, -lc_height + u + u);
fix_dimens(wd.fraction, ht.fraction, 0, 0);
ghost_stem bot, top;
standard_exact_hsbw("percent");
endglyph;

```

Construction of the character ampersand:

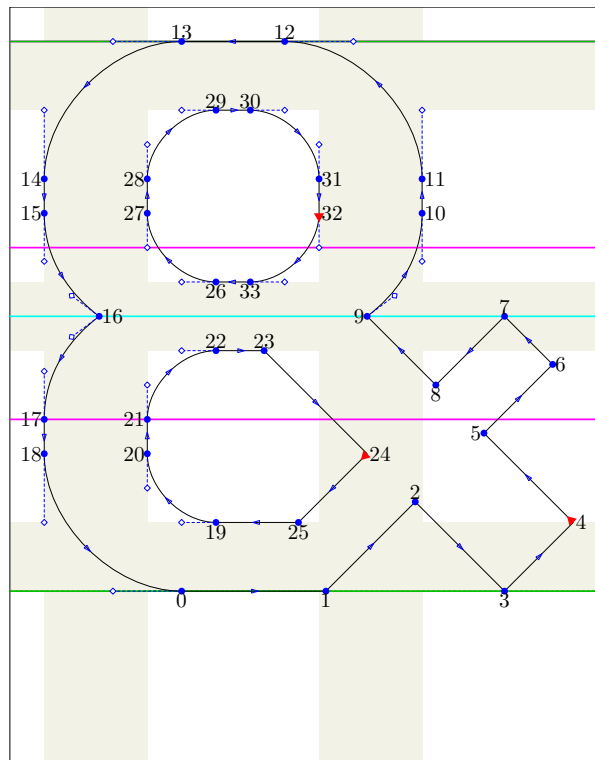

```

encode("ampersand")(38); standard_introduce("ampersand");
beginglyph(ampersand);
 $y_0 = y_1 = y_3 = 0; x_{14} = x_{15} = x_{17} = x_{18} = \text{leftstemloc}; y_{12} = y_{13} = \text{uc\_height};$ 
 $x_{28} - x_{14} = x_{27} - x_{15} = x_{21} - x_{17} = x_{20} - x_{18} = x_{11} - x_{31}$ 
 $= x_{10} - x_{32} = px; y_{13} - y_{29} = y_{12} - y_{30} = y_{19} - y_0 = y_{25} - y_1 = y_{26} - y_{22}$ 
 $= y_{33} - y_{23} = py; y_7 = y_9 = y_{16} = .5\text{uc\_height} = .5[y_{22}, y_{26}] = .5[y_{23}, y_{33}];$ 
 $z_0 = z_{18} + (\text{obow}, -\text{obow}); z_{14} = z_{13} - (\text{obow}, \text{obow}); z_{12} = z_{11} + (-\text{obow}, \text{obow});$ 
 $z_{20} = z_{19} + (-\text{ibow}, \text{ibow}); z_{22} = z_{21} + (\text{ibow}, \text{ibow}); z_{27} = z_{26} + (-\text{ibow}, \text{ibow});$ 
 $z_{29} = z_{28} + (\text{ibow}, \text{ibow}); z_{31} = z_{30} + (\text{ibow}, -\text{ibow}); z_{33} = z_{32} - (\text{ibow}, \text{ibow});$ 
 $x_{30} - x_{29} = x_{33} - x_{26} = x_{23} - x_{22} - 2u = x_{25} - x_{19} - 1xu - 2u = 1xu; x_1 - x_{25} = 4u;$ 
 $y_{15} - y_{16} = y_{16} - y_{17} = y_{10} - y_9 = \text{obow} - .5py; x_{16} - x_{15} = x_{10} - x_9 = .4\text{obow};$ 
 $x_3 - x_{23} = y_{23} - y_3; y_9 - y_4 = x_4 - x_9; y_4 - y_3 = x_4 - x_3; x_7 - x_{25} = y_7 - y_{25}; y_6 - y_1 = x_6 - x_1; y_7 - y_6 = x_6 - x_7;$ 
 $z_8 = \text{whatever}[z_{25}, z_7] = \text{whatever}[z_9, z_4]; z_5 = \text{whatever}[z_1, z_6] = \text{whatever}[z_9, z_4];$ 
 $z_{24} = \text{whatever}[z_{25}, z_7] = \text{whatever}[z_3, z_{23}]; z_2 = \text{whatever}[z_1, z_6] = \text{whatever}[z_3, z_{23}];$ 
Fill  $z_0$  --  $z_1$  --  $z_2$  --  $z_3$  --  $z_4$  --  $z_5$  --  $z_6$  --  $z_7$  --  $z_8$  -- bay right(9, 10) -- crescent up(11, 12)
  -- crescent left(13, 14) -- bay down(15, 16) & bay left(16, 17)
  -- crescent down(18, 0) & cycle;
unFill bow left(19, 20) -- bow up(21, 22) --  $z_{23}$  --  $z_{24}$  --  $z_{25}$  -- cycle, bow left(26, 27)
  -- bow up(28, 29) -- bow right(30, 31) -- bow down(32, 33) -- cycle;

fix_vstem( $px$ )(glyph_stored.glyph_name 1, glyph_stored.glyph_name 3);
fix_hstem( $py$ )(glyph_stored.glyph_name 1, glyph_stored.glyph_name 2,
  glyph_stored.glyph_name 3);
fix_dims( $\text{round}(x_4 + \text{rightbear}), y_{12}, 0, 0$ );

just_labels bot(0, 1, 3, 8, 19, 25, 26, 33);
just_labels top(2, 7, 12, 13, 22, 23, 29, 30);
just_labels lft(5, 9, 14, 15, 17, 18, 20, 21, 27, 28);
just_labels rt(4, 6, 10, 11, 16, 24, 31, 32);

standard_exact_hsbw("ampersand");
endglyph;

```

Construction of the character quotesingle:

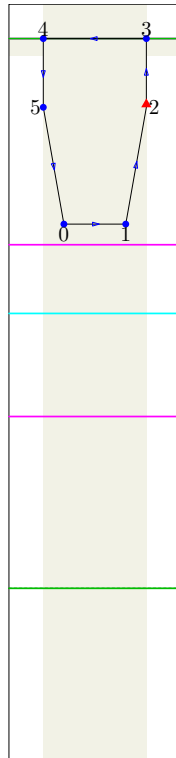

```

encode("quotesingle")(39); standard_introduce("quotesingle");
begin_glyph(quotesingle);
 $x_4 = x_5 = \text{leftstemloc}; y_3 = y_4 = \text{uc\_height};$ 
 $y_4 - y_5 = y_3 - y_2 = 2xu; y_5 - y_0 = y_2 - y_1 = 3xu + 2u;$ 
 $x_0 - x_5 = x_2 - x_1 = 3u;$ 
 $x_2 - x_5 = x_3 - x_4 = px;$ 

Fill  $z_0$  --  $z_1$  --  $z_2$  --  $z_3$  --  $z_4$  --  $z_5$  -- cycle;

fix_vstem( $px$ )(glyph_stored.glyph_name 1);
ghost_stem top;
fix_dimens( $x_2 + \text{rightbear}, y_3, 0, 0$ );

just_labels bot(0, 1);
just_labels top(3, 4);
just_labels rt(2);
just_labels lft(5);
standard_exact_hsbw("quotesingle");
end_glyph;

```

Construction of the character parenleft:

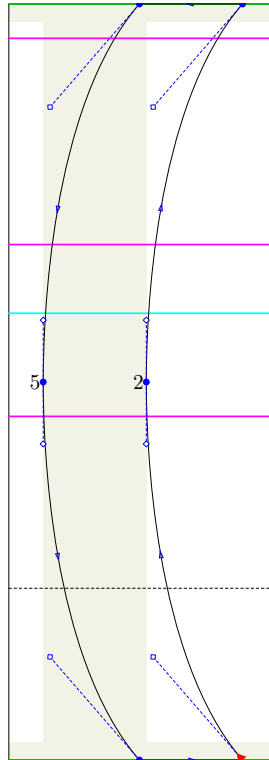

```

encode("parenleft")(40); standard_introduce("parenleft");
beginglyph (parenleft);
 $y_0 = y_1 = \text{descender}$ ;  $x_5 = \text{leftstemloc}$ ;  $y_3 = y_4 = \text{ascender}$ ;
 $x_0 = x_4 = x_5 + 3xu - u$ ;  $y_5 = y_2 = .5[y_0, y_4]$ ;  $x_3 - x_4 = x_2 - x_5 = x_1 - x_0 = px$ ;

Fill  $z_0$  --  $z_1$  .. controls( $x_1 - 3xu + 2u, y_1 + 3xu$ ) and ( $x_2, y_2 - 2xu + u$ )
  ..  $z_2$  .. controls( $x_2, y_2 + 2xu - u$ ) and ( $x_3 - 3xu + 2u, y_3 - 3xu$ ) ..  $z_3$ 
  --  $z_4$  .. controls( $x_4 - 3xu + 2u, y_4 - 3xu$ ) and ( $x_5, y_5 + 2xu - u$ )
  ..  $z_5$  .. controls( $x_5, y_5 - 2xu + u$ ) and ( $x_0 - 3xu + 2u, y_0 + 3xu$ ) ..  $z_0$  & cycle;

fix_vstem( $px$ )(glyph_stored.glyph_name 1);
ghost_stem top, bot;
fix_dimens( $x_1 + \text{rightbear}, y_3, y_0, 0$ );

just_labels bot(0, 1);
just_labels top(3, 4);
just_labels lft(2, 5);
standard_exact_hsbw("parenleft");
endglyph;

```

Construction of the character parenright:

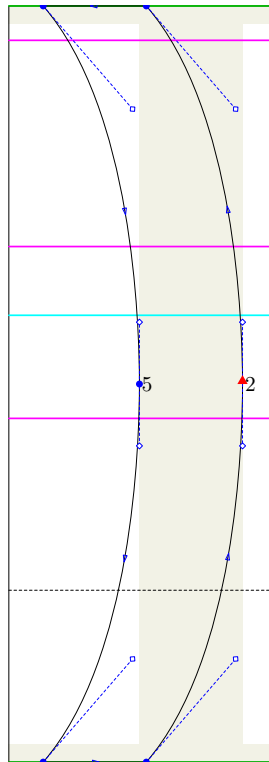

```

encode("parenright")(41); standard_introduce("parenright");
beginglyph(parenright);
 $y_0 = y_1 = \text{descender}$ ;  $x_0 = x_4 = \text{leftstemloc}$ ;  $y_3 = y_4 = \text{ascender}$ ;
 $x_5 - x_0 = 3xu - u$ ;  $y_5 = y_2 = .5[y_0, y_4]$ ;  $x_3 - x_4 = x_2 - x_5 = x_1 - x_0 = px$ ;

Fill  $z_0$  --  $z_1$  .. controls( $x_1 + 3xu - 2u, y_1 + 3xu$ ) and ( $x_2, y_2 - 2xu + u$ )
  ..  $z_2$  .. controls( $x_2, y_2 + 2xu - u$ ) and ( $x_3 + 3xu - 2u, y_3 - 3xu$ ) ..  $z_3$ 
  --  $z_4$  .. controls( $x_4 + 3xu - 2u, y_4 - 3xu$ ) and ( $x_5, y_5 + 2xu - u$ )
  ..  $z_5$  .. controls( $x_5, y_5 - 2xu + u$ ) and ( $x_0 + 3xu - 2u, y_0 + 3xu$ ) ..  $z_0$  & cycle;

fix_vstem( $px$ )(glyph_stored.glyph_name 1);
ghost_stem top, bot;
fix_dimens( $x_2 + \text{rightbear}, y_3, y_0, 0$ );

just_labels bot(0, 1);
just_labels top(3, 4);
just_labels rt(2, 5);
standard_exact_hsbw("parenright");
endglyph;

```

Construction of the character asterisk:

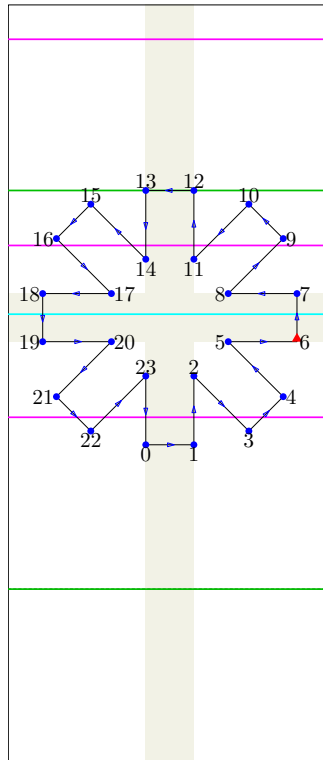

```

encode("asterisk")(42); standard_introduce("asterisk");
beginlyph(asterisk);
x18 = x19 = leftstemloc;
.5[y5, y8] = .5[y6, y7] = .5[y19, y18] = .5[y20, y17] = .5uc_height - .5u;
x1 - x0 = x2 - x23 = x11 - x14 = x12 - x13 = py - 3u% Stem size
= y7 - y6 = y8 - y5 = y17 - y20 = y18 - y19;
x6 - x5 = x7 - x8 = x17 - x18 = x20 - x19 = 2xu% Outer cross shift
= y23 - y0 = y2 - y1 = y12 - y11 = y13 - y14;
x5 - x2 = x8 - x11 = x14 - x17 = x23 - x20 = xu% Inner cross shift
= y5 - y2 = y11 - y8 = y14 - y17 = y20 - y23;
y13 - y15 = y12 - y10 = y22 - y0 = y3 - y1 = 2u; % Cross distance
y2 - y3 = x3 - x2 = y5 - y4 = x4 - x5;
y9 - y8 = x9 - x8 = y10 - y11 = x10 - x11;
y15 - y14 = x14 - x15 = y16 - y17 = x17 - x16;
y20 - y21 = x20 - x21 = y23 - y22 = x23 - x22;
x0 = x23; x12 = x11;

Fill z0 -- z1 -- z2 -- z3 -- z4 -- z5 -- z6 -- z7 -- z8 -- z9 -- z10 -- z11 -- z12 -- z13
-- z14 -- z15 -- z16 -- z17 -- z18 -- z19 -- z20 -- z21 -- z22 -- z23 -- cycle;

fix_vstem(py - 3u)(glyph_stored.glyph_name 1);
fix_hstem(py - 3u)(glyph_stored.glyph_name 1);
fix_dimens(x6 + rightbear, y12, 0, 0);

just_labels bot(0, 1, 3, 11, 14, 22);
just_labels top(2, 10, 12, 13, 15, 23);
just_labels rt(4, 6, 7, 9, 17, 20);
just_labels lft(5, 8, 16, 18, 19, 21);
standard_exact_hsbw("asterisk");
endglyph;

```

Construction of the character plus:

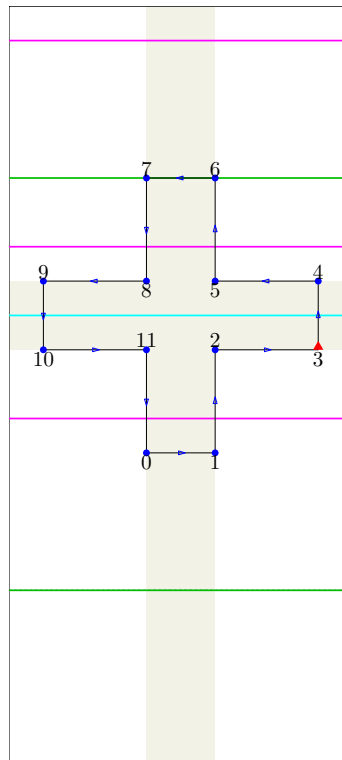

```

encode("plus")(43); standard_introduce("plus");
begin_glyph(plus);
x9 = x10 = leftstemloc;
.5[y2, y5] = .5[y3, y4] = .5[y10, y9] = .5[y11, y8] = math_axis;
y4 - y3 = y5 - y2 = y8 - y11 = y9 - y10 = py% Stem size
= x1 - x0 = x2 - x11 = x5 - x8 = x6 - x7;
x7 = x8; x11 = x0;
x8 - x9 = x11 - x10 = x3 - x2 = x4 - x5 = 3xu% Stem extension
= y11 - y0 = y2 - y1 = y6 - y5 = y7 - y8;

Fill z0 -- z1 -- z2 -- z3 -- z4 -- z5 -- z6 -- z7 -- z8 -- z9 -- z10 -- z11 -- cycle;

fix_vstem(py)(glyph_stored.glyph_name 1);
fix_hstem(py)(glyph_stored.glyph_name 1);
fix_dimens(x3 + rightbear, y6, 0, 0);

just_labels bot(0, 1, 3, 5, 8, 10);
just_labels top(2, 4, 6, 7, 9, 11);
standard_exact_hsbw("plus");
end_glyph;

```

Construction of the character comma:

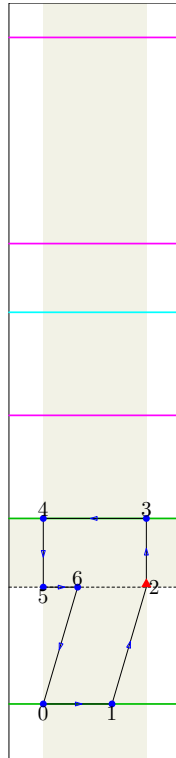

```

encode("comma")(44); standard_introduce("comma");
beginglyph(comma);
 $y_2 = y_5 = y_6 = 0$ ;  $x_0 = x_4 = x_5 = \textit{leftstemloc}$ ;
 $x_2 - x_5 = x_3 - x_4 = px$ ;  $x_2 - x_6 = x_1 - x_0 = 2xu$ ;
 $y_4 - y_5 = y_3 - y_2 = py$ ;
 $y_6 - y_0 = y_2 - y_1 = 3xu + 2u$ ;

Fill  $z_0$  --  $z_1$  --  $z_2$  --  $z_3$  --  $z_4$  --  $z_5$  --  $z_6$  -- cycle;

fix_vstem( $px$ )(glyph_stored.glyph_name 1);
fix_hstem( $py$ )(glyph_stored.glyph_name 1);
fix_dimens( $x_2 + \textit{rightbear}$ ,  $y_3$ ,  $y_0$ , 0);

just_labels bot(0, 1, 5);
just_labels top(3, 4, 6);
just_labels rt(2);

standard_exact_hsbw("comma");
endglyph;

```

Construction of the character hyphen:

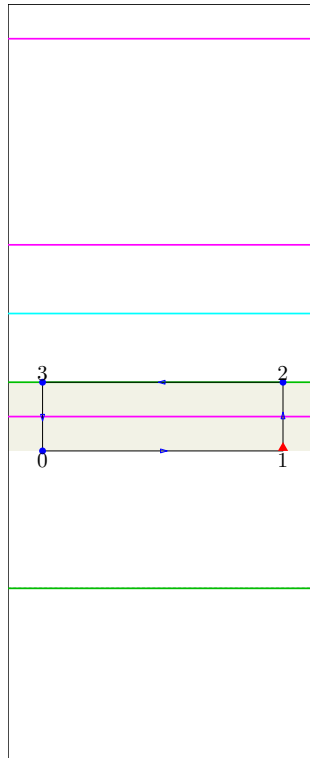

```

encode("hyphen")(45); standard_introduce("hyphen");
begin_glyph(hyphen);
 $x_0 = x_3 = \text{leftstemloc}$ ;
 $.5[y_0, y_3] = .5[y_1, y_2] = .5lc\_height$ ;  $y_3 - y_0 = y_2 - y_1 = py$ ;
 $x_2 - x_3 = x_1 - x_0 = 7xu$ ;

Fill  $z_0$  --  $z_1$  --  $z_2$  --  $z_3$  -- cycle;

fix_hstem(py)(glyph_stored.glyph_name 1);
fix_dimens( $x_1 + \text{rightbear}$ ,  $y_2$ , 0, 0);

just_labels bot(0, 1);
just_labels top(2, 3);
standard_exact_hsbw("hyphen");
end_glyph;

```

Construction of the character period:

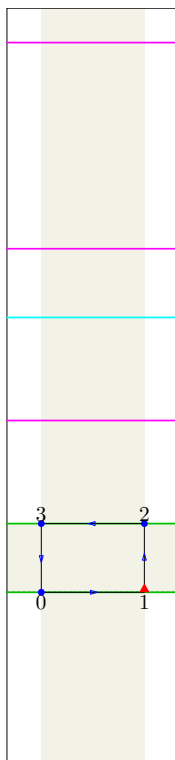

```

encode("period")(46); standard_introduce("period");
beginglyph(period);
 $y_0 = y_1 = 0; x_0 = x_3 = \text{leftstemloc};$ 
 $x_1 - x_0 = x_2 - x_3 = px; y_3 - y_0 = y_2 - y_1 = py;$ 
Fill  $z_0$  --  $z_1$  --  $z_2$  --  $z_3$  -- cycle;
fix_vstem( $px$ )(glyph_stored.glyph_name 1);
fix_hstem( $py$ )(glyph_stored.glyph_name 1);
fix_dimens( $x_1 + \text{rightbear}, y_2, 0, 0$ );
just_labels bot(0, 1);
just_labels top(2, 3);
standard_exact_hsbw("period");
endglyph;

```

Construction of the character slash:

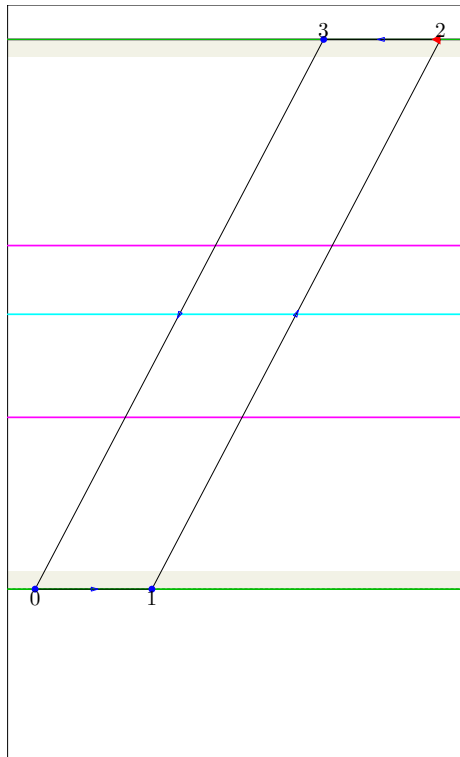

```

encode("slash")(47); standard_introduce("slash");
beginlyph(slash);
 $y_0 = y_1 = 0; x_0 = \text{leftstemloc} - o; y_2 = y_3 = \text{uc.height};$ 
 $x_1 - x_0 = x_2 - x_3 = px + u + o; x_3 - x_1 = 5xu;$ 
Fill  $z_0$  --  $z_1$  --  $z_2$  --  $z_3$  -- cycle;
ghost_stem top, bot;
fix_dimens( $x_2 + \text{rightbear} - o, y_2, 0, 0$ );
just_labels bot(0, 1);
just_labels top(2, 3);
standard_exact_hsbw("slash");
endglyph;

```

Construction of the character zero:

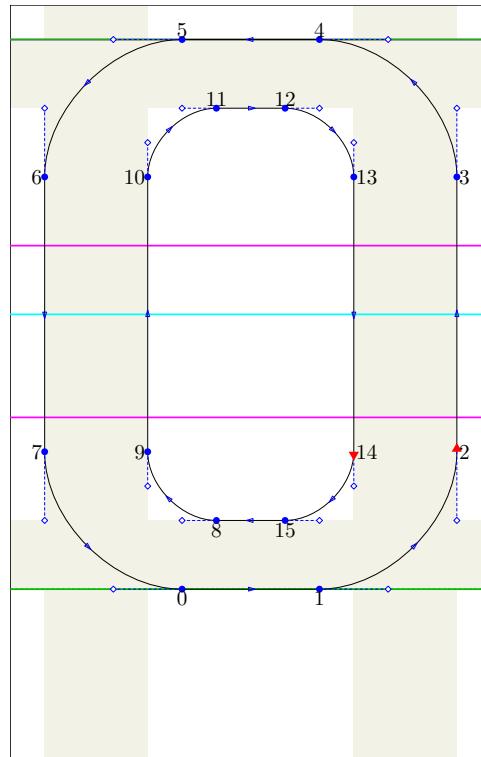

```

encode("zero")(48); standard_introduce("zero");
beginglyph(zero);
y0 = y1 = 0; x6 = x7 = leftstemloc; y4 = y5 = uc_height;
x10 - x6 = x9 - x7 = x3 - x13 = x2 - x14 = px;
x12 - x11 = x15 - x8 = 2xu;
y8 - y0 = y15 - y1 = y5 - y11 = y4 - y12 = py;
z2 = z1 + (obow, obow); z4 = z3 + (-obow, obow); z6 = z5 - (obow, obow);
z0 = z7 + (obow, -obow);
z9 = z8 + (-ibow, ibow); z11 = z10 + (ibow, ibow); z13 = z12 + (ibow, -ibow);
z15 = z14 - (ibow, ibow);

Fill z0 -- crescent right(1, 2) -- crescent up(3, 4) -- crescent left(5, 6)
-- crescent down(7, 0) & cycle;
unFill bow left(8, 9) -- bow up(10, 11) -- bow right(12, 13) -- bow down(14, 15)
-- cycle;

fix_hstem(py)(glyph_stored.glyph_name 1, glyph_stored.glyph_name 2);
fix_vstem(px)(glyph_stored.glyph_name 1, glyph_stored.glyph_name 2);
fix_dimens(x2 + rightbear, y4, 0, 0);

just_labels bot(0, 1, 8, 15);
just_labels top(4, 5, 11, 12);
just_labels rt(2, 3, 13, 14);
just_labels lft(6, 7, 9, 10);

standard_exact_hsbw("zero");
endglyph;

```

Construction of the character one:

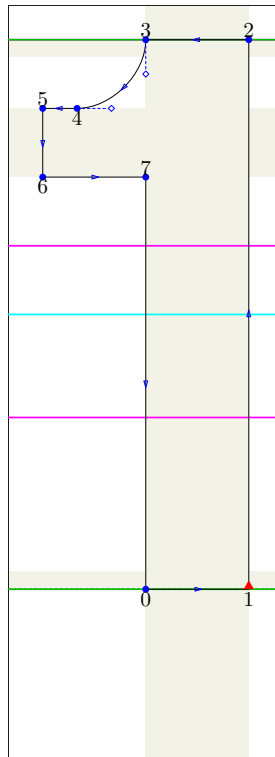

```

encode("one")(49); standard_introduce("one");
begin_glyph(one);
 $y_0 = y_1 = 0$ ;  $x_5 = x_6 = \text{leftstemloc}$ ;  $y_2 = y_3 = \text{uc\_height}$ ;
 $x_0 = x_3 = x_7$ ;  $x_4 - x_5 = xu$ ;  $x_1 - x_0 = x_2 - x_3 = px$ ;  $y_5 - y_6 = y_4 - y_7 = py$ ;  $y_5 = y_4$ ;
 $z_4 = z_3 - (\text{ibow}, \text{ibow})$ ;

Fill  $z_0$  --  $z_1$  --  $z_2$  -- bow down(3, 4) --  $z_5$  --  $z_6$  --  $z_7$  -- cycle;

fix_hstem(py)(glyph_stored.glyph_name 1)(y < uc_height);
fix_vstem(px)(glyph_stored.glyph_name 1)(x > leftstemloc);
fix_dimens( $x_1 + \text{rightbear}$ ,  $y_3$ , 0, 0);
ghost_stem bot, top;

just_labels bot(0, 1, 4, 6);
just_labels top(2, 3, 5, 7);

standard_exact_hsbw("one");
end_glyph;

```

Construction of the character two:

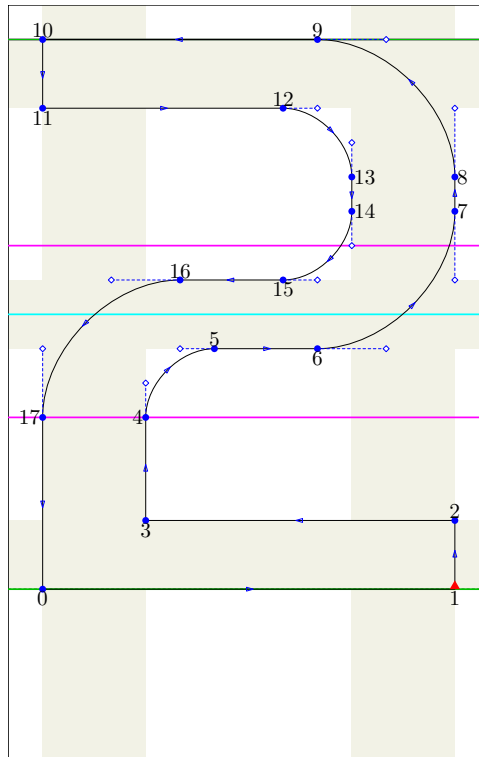

```

encode("two")(50); standard_introduce("two");
beginlyph(two);
 $y_0 = y_1 = 0; x_{10} = x_{11} = x_{17} = x_0 = \text{leftstemloc}; y_9 = y_{10} = \text{uc\_height};$ 
 $x_8 - x_{13} = x_7 - x_{14} = x_4 - x_{17} = x_3 - x_0 = px; x_{15} - x_5 = 2xu;$ 
 $.5[y_5, y_{16}] = .5[y_6, y_{15}] = .5\text{uc\_height};$ 
 $y_{16} - y_5 = y_{15} - y_6 = y_2 - y_1$ 
 $= y_3 - y_0 = y_9 - y_{12} = y_{10} - y_{11} = py;$ 
 $x_1 = x_2 = x_7 = x_8;$ 
 $z_5 = z_4 + (\text{ibow}, \text{ibow}); z_7 = z_6 + (\text{obow}, \text{obow}); z_9 = z_8 + (-\text{obow}, \text{obow});$ 
 $z_{13} = z_{12} + (\text{ibow}, -\text{ibow}); z_{15} = z_{14} - (\text{ibow}, \text{ibow}); z_{17} = z_{16} - (\text{obow}, \text{obow});$ 

Fill  $z_0$  --  $z_1$  --  $z_2$  --  $z_3$  -- bow up(4, 5) -- crescent right(6, 7)
  -- crescent up(8, 9) --  $z_{10}$  --  $z_{11}$  -- bow right(12, 13) -- bow down(14, 15)
  -- crescent left(16, 17) -- cycle;

fix_hstem( $py$ )(glyph_stored.glyph_name 1);
fix_vstem( $px$ )(glyph_stored.glyph_name 1);
fix_dimens( $x_1 + \text{rightbear}, y_9, 0, 0$ );

just_labels bot(0, 1, 3, 6, 11, 15);
just_labels top(2, 5, 9, 10, 12, 16);
just_labels rt(7, 8, 13, 14);
just_labels lft(4, 17);

standard_exact_hsbw("two");
endglyph;

```

Construction of the character three:

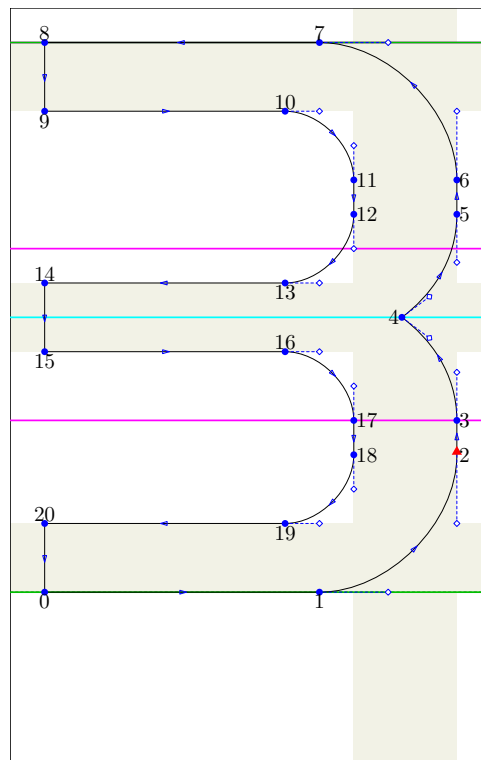

```

encode("three")(51); standard_introduce("three");
beginlyph(three);
 $y_0 = y_1 = 0; x_0 = x_8 = x_9 = x_{14} = x_{15} = x_{20} = \text{leftstemloc}; y_7 = y_8 = \text{uc\_height};$ 
 $x_3 - x_{17} = x_2 - x_{18} = x_5 - x_{12} = x_6 - x_{11} = px;$ 
 $x_{10} - x_9 = x_{13} - x_{14} = x_{16} - x_{15} = x_{19} - x_{20} = 7xu;$ 
 $y_8 - y_9 = y_7 - y_{10} = y_{14} - y_{15}$ 
 $= y_{13} - y_{16} = y_{20} - y_0 = y_{19} - y_1 = py;$ 
 $.5[y_{15}, y_{14}] = .5[y_{16}, y_{13}] = y_4 = .5\text{uc\_height}; y_4 - y_3 = y_5 - y_4 = \text{obow} - .5py; x_4 = x_3 - .4\text{obow};$ 
 $z_2 = z_1 + (\text{obow}, \text{obow}); z_7 = z_6 + (-\text{obow}, \text{obow}); z_{11} = z_{10} + (\text{ibow}, -\text{ibow});$ 
 $z_{13} = z_{12} - (\text{ibow}, \text{ibow}); z_{17} = z_{16} + (\text{ibow}, -\text{ibow}); z_{19} = z_{18} - (\text{ibow}, \text{ibow});$ 

Fill  $z_0$  -- crescent right(1, 2) -- bay up(3, 4) & bay right(4, 5)
  -- crescent up(6, 7) --  $z_8$  --  $z_9$  -- bow right(10, 11) -- bow down(12, 13)
  --  $z_{14}$  --  $z_{15}$  -- bow right(16, 17) -- bow down(18, 19) --  $z_{20}$  -- cycle;

fix_hstem( $py$ )(glyph_stored.glyph_name 1);
fix_vstem( $px$ )(glyph_stored.glyph_name 1);
fix_dims( $x_2 + \text{rightbear}, y_7, 0, 0$ );

just_labels bot(0, 1, 9, 13, 15, 19);
just_labels top(7, 8, 10, 14, 16, 20);
just_labels rt(2, 3, 5, 6, 11, 12, 17, 18);
just_labels lft(4);

standard_exact_hsbw("three");
endglyph;

```

Construction of the character four:

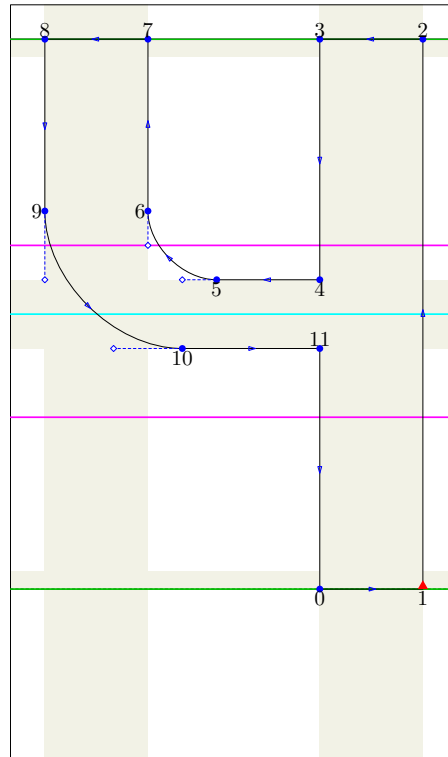

```

encode("four")(52); standard_introduce("four");
beginlyph(four);
 $y_0 = y_1 = 0; x_8 = x_9 = \text{leftstemloc}; y_2 = y_3 = y_7 = y_8 = \text{uc\_height};$ 
 $x_7 - x_8 = x_6 - x_9 = x_2 - x_3 = x_1 - x_0 = \text{px};$ 
 $x_0 = x_3 = x_4 = x_{11} = x_5 + 3xu;$ 
 $.5[y_{10}, y_5] = .5[y_{11}, y_4] = .5\text{uc\_height}; y_4 - y_{11} = y_5 - y_{10} = \text{py};$ 
 $z_6 = z_5 + (-\text{ibow}, \text{ibow}); z_{10} = z_9 + (\text{obow}, -\text{obow});$ 

Fill  $z_0$  --  $z_1$  --  $z_2$  --  $z_3$  --  $z_4$  -- bow left(5, 6) --  $z_7$  --  $z_8$  -- crescent down(9, 10)
  --  $z_{11}$  -- cycle;

fix_hstem( $\text{py}$ )(glyph_stored.glyph_name 1);
fix_vstem( $\text{px}$ )(glyph_stored.glyph_name 1);
fix_dimens( $x_1 + \text{rightbear}$ ,  $y_2$ , 0, 0);

ghost_stem top, bot;

just_labels bot(0, 1, 4, 5, 10);
just_labels top(2, 3, 7, 8, 11);
just_labels lft(6, 9);

standard_exact_hsbw("four");
endglyph;

```

Construction of the character five:

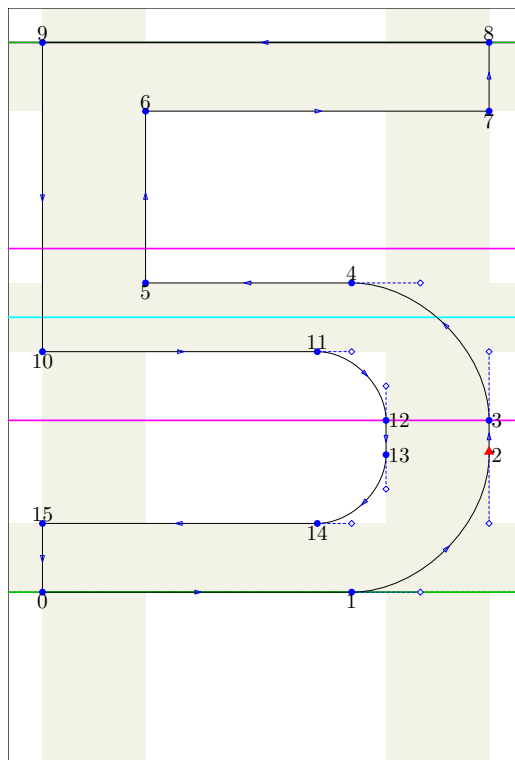

```

encode("five")(53); standard_introduce("five");
beginlyph(five);
 $y_0 = y_1 = 0; x_0 = x_9 = x_{10} = x_{15} = \text{leftstemloc}; y_8 = y_9 = \text{uc\_height};$ 
 $x_6 - x_9 = x_5 - x_{10} = x_3 - x_{12} = x_2 - x_{13} = px;$ 
 $x_{11} - x_5 = 5xu; x_2 = x_3 = x_7 = x_8;$ 
 $y_{15} - y_0 = y_{14} - y_1 = y_4 - y_{11}$ 
 $= y_5 - y_{10} = y_9 - y_6 = y_8 - y_7 = py;$ 
 $.5[y_{10}, y_5] = .5[y_{11}, y_4] = .5\text{uc\_height};$ 
 $z_2 = z_1 + (\text{obow}, \text{obow}); z_4 = z_3 + (-\text{obow}, \text{obow}); z_{12} = z_{11} + (\text{ibow}, -\text{ibow});$ 
 $z_{14} = z_{13} - (\text{ibow}, \text{ibow});$ 

Fill  $z_0$  -- crescent right(1, 2) -- crescent up(3, 4) --  $z_5$  --  $z_6$  --  $z_7$  --  $z_8$ 
--  $z_9$  --  $z_{10}$  -- bow right(11, 12) -- bow down(13, 14) --  $z_{15}$  -- cycle;

fix_hstem( $py$ )(glyph_stored.glyph_name 1);
fix_vstem( $px$ )(glyph_stored.glyph_name 1);
fix_dims( $x_2 + \text{rightbear}, y_8, 0, 0$ );

just_labels bot(0, 1, 5, 7, 10, 14);
just_labels top(4, 6, 8, 9, 11, 15);
just_labels rt(2, 3, 12, 13);

standard_exact_hsbw("five");
endglyph;

```

Construction of the character six:

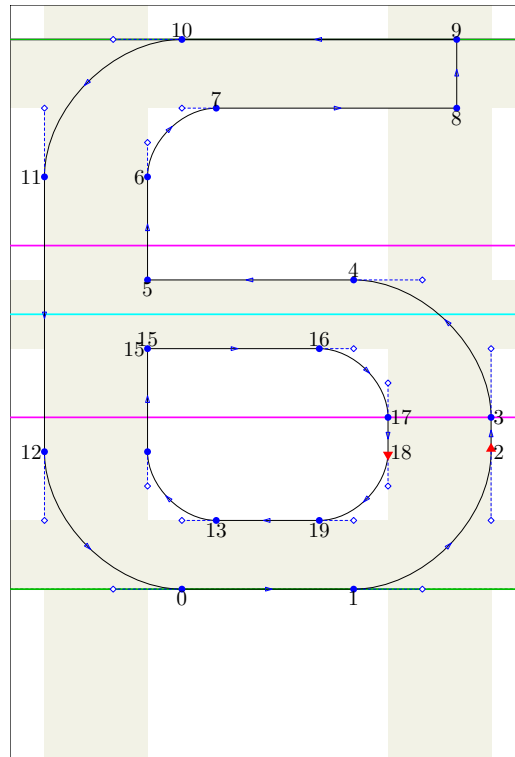

```

encode("six")(54); standard_introduce("six");
beginlyph(six);
 $y_0 = y_1 = 0; x_{11} = x_{12} = \text{leftstemloc}; y_9 = y_{10} = \text{uc\_height};$ 
 $x_2 - x_{18} = x_3 - x_{17} = x_{14} - x_{12} = x_6 - x_{11} = px; x_{15} = x_{14}; x_6 = x_5;$ 
 $x_{19} - x_{13} = 3xu; x_2 = x_3; x_8 = x_9; x_3 - x_8 = xu;$ 
 $y_{13} - y_0 = y_{19} - y_1 = y_4 - y_{16}$ 
 $= y_5 - y_{15} = y_9 - y_8 = y_{10} - y_7 = py;$ 
 $.5[y_{15}, y_5] = .5[y_{16}, y_4] = .5\text{uc\_height};$ 
 $z_2 = z_1 + (\text{obow}, \text{obow}); z_4 = z_3 + (-\text{obow}, \text{obow}); z_7 = z_6 + (\text{ibow}, \text{ibow});$ 
 $z_{11} = z_{10} - (\text{obow}, \text{obow}); z_0 = z_{12} + (\text{obow}, -\text{obow}); z_{14} = z_{13} + (-\text{ibow}, \text{ibow});$ 
 $z_{17} = z_{16} + (\text{ibow}, -\text{ibow}); z_{19} = z_{18} - (\text{ibow}, \text{ibow});$ 

Fill  $z_0$  -- crescent right(1, 2) -- crescent up(3, 4) --  $z_5$  -- bow up(6, 7)
  --  $z_8$  --  $z_9$  -- crescent left(10, 11) -- crescent down(12, 0) & cycle;
unFill bow left(13, 14) --  $z_{15}$  -- bow right(16, 17) -- bow down(18, 19) -- cycle;

fix_hstem( $py$ )(glyph_stored.glyph_name 1, glyph_stored.glyph_name 2);
fix_vstem( $px$ )(glyph_stored.glyph_name 1, glyph_stored.glyph_name 2);
fix_dims( $x_2 + \text{rightbear}, y_9, 0, 0$ );

just_labels bot(0, 1, 5, 8, 13, 19);
just_labels top(4, 7, 9, 10, 15, 16);
just_labels rt(2, 3, 17, 18);
just_labels lft(6, 11, 12, 15);

standard_exact_hsbw("six");
endglyph;

```

Construction of the character seven:

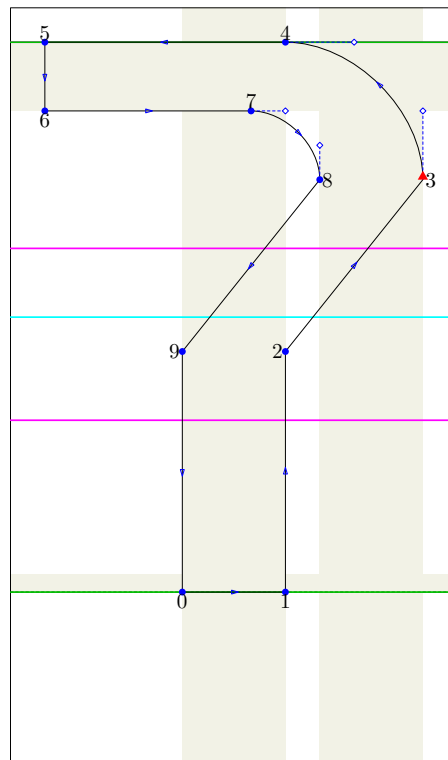

```
encode("seven")(55); standard_introduce("seven");
```

```
beginglyph(seven);
```

```
 $y_0 = y_1 = 0$ ;  $x_5 = x_6 = \text{leftstemloc}$ ;  $y_4 = y_5 = \text{uc\_height}$ ;
```

```
 $x_1 - x_0 = x_2 - x_9 = x_3 - x_8 = px$ ;
```

```
 $x_9 - x_6 = x_3 - x_2 = 4xu$ ;  $x_0 = x_9$ ;
```

```
 $y_5 - y_6 = y_4 - y_7 = py$ ;  $y_2 = y_9 = .5[y_7, y_1]$ ;
```

```
 $z_4 = z_3 + (-obow, obow)$ ;  $z_8 = z_7 + (ibow, -ibow)$ ;
```

```
Fill  $z_0$  --  $z_1$  --  $z_2$  -- crescent up(3, 4) --  $z_5$  --  $z_6$  -- bow right(7, 8) --  $z_9$  -- cycle;
```

```
fix_hstem(py)(glyph_stored.glyph_name 1);
```

```
fix_vstem(px)(glyph_stored.glyph_name 1);
```

```
fix_dimens( $x_3 + \text{rightbear}$ ,  $y_4$ , 0, 0);
```

```
ghost_stem bot;
```

```
just_labels bot(0, 1, 6);
```

```
just_labels top(4, 5, 7);
```

```
just_labels rt(3, 8);
```

```
just_labels lft(2, 9);
```

```
standard_exact_hsbw("seven");
```

```
endglyph;
```

Construction of the character eight:

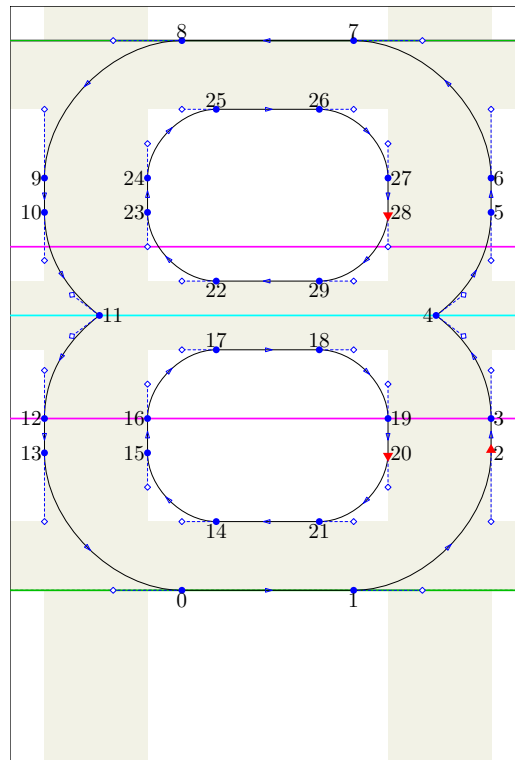

```

encode("eight")(56); standard_introduce("eight");
beginlyph(eight);
 $y_0 = y_1 = 0; x_9 = x_{10} = x_{12} = x_{13} = \text{leftstemloc}; y_7 = y_8 = \text{uc\_height};$ 
 $x_{15} - x_{13} = x_{16} - x_{12} = x_{23} - x_{10} = x_{24} - x_9 = x_6 - x_{27}$ 
 $= x_5 - x_{28} = x_3 - x_{19} = x_2 - x_{20} = px; x_{21} - x_{14} = x_{18} - x_{17} = x_{29} - x_{22} = x_{26} - x_{25} = 3xu;$ 
 $y_{14} - y_0 = y_{21} - y_1 = y_{29} - y_{18} = y_{22} - y_{17} = y_7 - y_{26}$ 
 $= y_8 - y_{25} = py; .5[y_{17}, y_{22}] = .5[y_{18}, y_{29}] = y_4 = y_{11} = .5uc\_height;$ 
 $y_4 - y_3 = y_5 - y_4 = y_{10} - y_{11} = y_{11} - y_{12} = \text{obow} - .5py; x_3 - x_4 = x_{11} - x_{12} = .4\text{obow};$ 
 $z_2 = z_1 + (\text{obow}, \text{obow}); z_7 = z_6 + (-\text{obow}, \text{obow}); z_9 = z_8 - (\text{obow}, \text{obow}); z_0 = z_{13} + (\text{obow}, -\text{obow});$ 
 $z_{15} = z_{14} + (-\text{ibow}, \text{ibow}); z_{17} = z_{16} + (\text{ibow}, \text{ibow}); z_{19} = z_{18} + (\text{ibow}, -\text{ibow});$ 
 $z_{21} = z_{20} - (\text{ibow}, \text{ibow}); z_{23} = z_{22} + (-\text{ibow}, \text{ibow}); z_{25} = z_{24} + (\text{ibow}, \text{ibow});$ 
 $z_{27} = z_{26} + (\text{ibow}, -\text{ibow}); z_{29} = z_{28} - (\text{ibow}, \text{ibow});$ 

Fill  $z_0$  -- crescent right(1, 2) -- bay up(3, 4) & bay right(4, 5)
  -- crescent up(6, 7) -- crescent left(8, 9) -- bay down(10, 11)
  & bay left(11, 12) -- crescent down(13, 0) & cycle;
unFill bow left(14, 15) -- bow up(16, 17) -- bow right(18, 19) -- bow down(20, 21)
  -- cycle, bow left(22, 23) -- bow up(24, 25) -- bow right(26, 27) -- bow down(28, 29)
  -- cycle;

fix_hstem( $py$ )(glyph_stored.glyph_name 1, glyph_stored.glyph_name 2,
  glyph_stored.glyph_name 3);
fix_vstem( $px$ )(glyph_stored.glyph_name 1, glyph_stored.glyph_name 2,
  glyph_stored.glyph_name 3);
fix_dimens( $x_2 + \text{rightbear}$ ,  $y_7$ , 0, 0);

just_labels bot(0, 1, 14, 21, 22, 29); just_labels top(7, 8, 17, 18, 25, 26);
just_labels rt(2, 3, 5, 6, 11, 19, 20, 27, 28);
just_labels lft(4, 9, 10, 12, 13, 15, 16, 23, 24);

standard_exact_hsbw("eight");
endglyph;

```

Construction of the character nine:

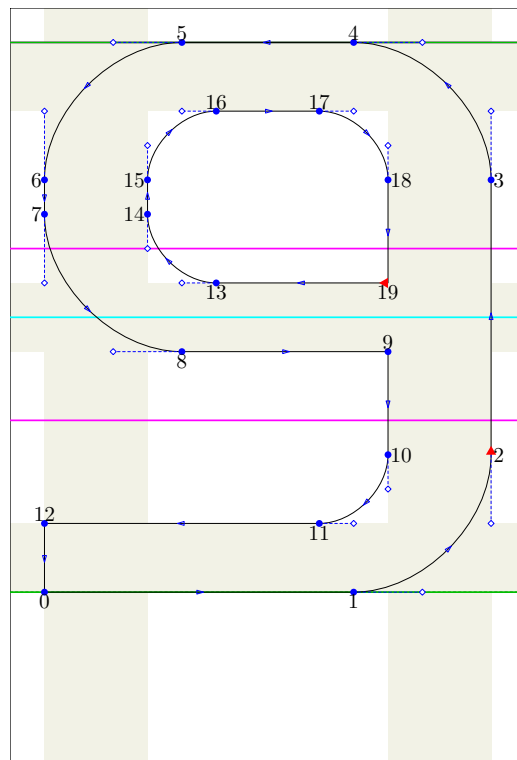

```

encode("nine")(57); standard_introduce("nine");
beginlyph(nine);
 $y_0 = y_1 = 0; x_0 = x_6 = x_7 = x_{12} = \text{leftstemloc}; y_4 = y_5 = \text{uc\_height};$ 
 $x_{15} - x_6 = x_{14} - x_7 = x_3 - x_{18} = x_2 - x_{10} = px;$ 
 $x_{17} - x_{16} = 3xu; x_9 = x_{10} = x_{19} = x_{18};$ 
 $y_{12} - y_0 = y_{11} - y_1 = y_{19} - y_9$ 
 $= y_{13} - y_8 = y_4 - y_{17} = y_5 - y_{16} = py;$ 
 $.5[y_8, y_{13}] = .5[y_9, y_{19}] = .5\text{uc\_height};$ 
 $z_2 = z_1 + (\text{obow}, \text{obow}); z_4 = z_3 + (-\text{obow}, \text{obow}); z_6 = z_5 - (\text{obow}, \text{obow});$ 
 $z_8 = z_7 + (\text{obow}, -\text{obow}); z_{11} = z_{10} - (\text{ibow}, \text{ibow}); z_{14} = z_{13} + (-\text{ibow}, \text{ibow});$ 
 $z_{16} = z_{15} + (\text{ibow}, \text{ibow}); z_{18} = z_{17} + (\text{ibow}, -\text{ibow});$ 

Fill  $z_0$  -- crescent right(1, 2) -- crescent up(3, 4) -- crescent left(5, 6)
-- crescent down(7, 8) --  $z_9$  -- bow down(10, 11) --  $z_{12}$  -- cycle;
unFill bow left(13, 14) -- bow up(15, 16) -- bow right(17, 18) --  $z_{19}$  -- cycle;

fix_hstem( $py$ )(glyph_stored.glyph_name 1, glyph_stored.glyph_name 2);
fix_vstem( $px$ )(glyph_stored.glyph_name 1, glyph_stored.glyph_name 2);
fix_dims( $x_2 + \text{rightbear}, y_4, 0, 0$ );

just_labels bot(0, 1, 8, 11, 13, 19);
just_labels top(4, 5, 9, 12, 16, 17);
just_labels rt(2, 3, 10, 18);
just_labels lft(6, 7, 14, 15);

standard_exact_hsbw("nine");
endglyph;

```

Construction of the character colon:

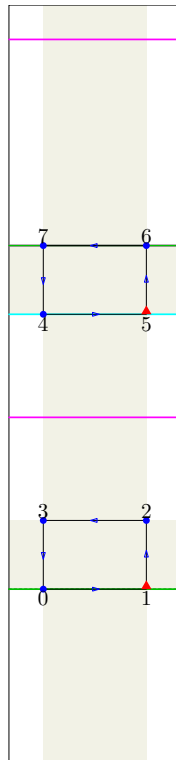

```

encode("colon")(58); standard_introduce("colon");
beginglyph(colon);
 $y_0 = y_1 = 0$ ;  $x_0 = x_3 = x_4 = x_7 = leftstemloc$ ;  $y_6 = y_7 = lc.height$ ;
 $x_1 - x_0 = x_2 - x_3 = x_5 - x_4 = x_6 - x_7 = px$ ;
 $y_3 - y_0 = y_2 - y_1 = y_6 - y_5 = y_7 - y_4 = py$ ;

Fill  $z_0$  --  $z_1$  --  $z_2$  --  $z_3$  -- cycle,  $z_4$  --  $z_5$  --  $z_6$  --  $z_7$  -- cycle;

fix_vstem( $px$ )(glyph_stored.glyph_name 1, glyph_stored.glyph_name 2);
fix_hstem( $py$ )(glyph_stored.glyph_name 1, glyph_stored.glyph_name 2);
fix_dimens( $x_1 + rightbear$ ,  $y_6$ , 0, 0);

just_labels bot(0, 1, 4, 5);
just_labels top(2, 3, 6, 7);

standard_exact_hsbw("colon");
endglyph;

```

Construction of the character semicolon:

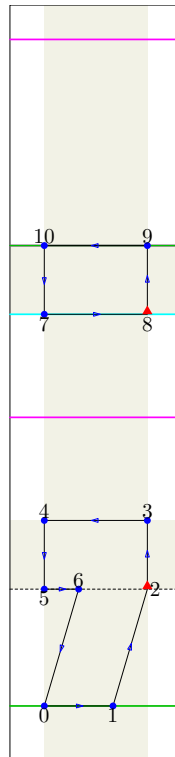

```

encode("semicolon")(59); standard_introduce("semicolon");
beginlyph(semicolon);
 $y_2 = y_5 = y_6 = 0$ ;  $x_0 = x_4 = x_5 = x_7 = x_{10} = \textit{leftstemloc}$ ;  $y_9 = y_{10} = \textit{lc\_height}$ ;
 $x_2 - x_5 = x_3 - x_4 = x_9 - x_{10} = x_8 - x_7 = px$ ;  $x_2 - x_6 = x_1 - x_0 = 2xu$ ;
 $y_4 - y_5 = y_3 - y_2 = y_9 - y_8 = y_{10} - y_7 = py$ ;
 $y_6 - y_0 = y_2 - y_1 = 3xu + 2u$ ;

Fill  $z_0$  --  $z_1$  --  $z_2$  --  $z_3$  --  $z_4$  --  $z_5$  --  $z_6$  -- cycle,
       $z_7$  --  $z_8$  --  $z_9$  --  $z_{10}$  -- cycle;

fix_vstem( $px$ )(glyph_stored.glyph_name 1, glyph_stored.glyph_name 2);
fix_hstem( $py$ )(glyph_stored.glyph_name 1, glyph_stored.glyph_name 2);
fix_dimens( $x_2 + \textit{rightbear}$ ,  $y_9$ ,  $y_0$ , 0);

just_labels bot(0, 1, 5, 7, 8);
just_labels top(3, 4, 6, 9, 10);
just_labels rt(2);

standard_exact_hsbw("semicolon");
endglyph;

```

Construction of the character less:

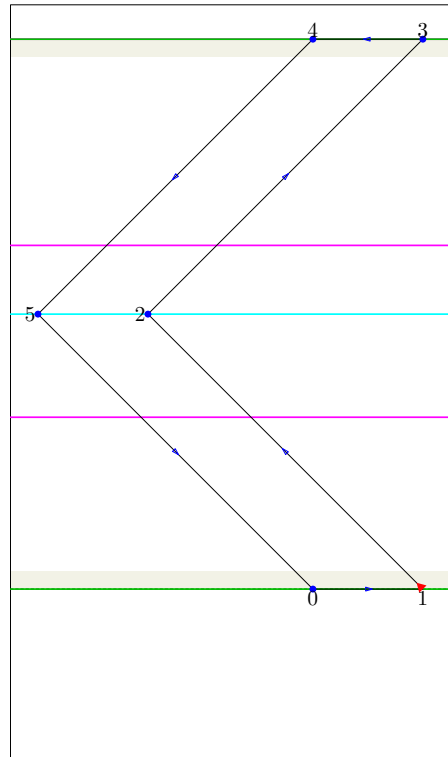

```

encode("less")(60); standard_introduce("less");
begin_glyph(less);
 $y_0 = y_1 = 0; x_5 = \text{leftstemloc} - o; y_3 = y_4 = \text{uc\_height};$ 
 $y_5 = y_2 = .5\text{uc\_height};$ 
 $x_1 - x_0 = x_2 - x_5 = x_3 - x_4 = px + o;$ 
 $x_0 - x_5 = y_5 - y_0; y_4 - y_5 = x_4 - x_5;$ 
Fill  $z_0$  --  $z_1$  --  $z_2$  --  $z_3$  --  $z_4$  --  $z_5$  -- cycle;
ghost_stem top, bot;
fix_dimens( $x_1 + \text{rightbear}$ ,  $y_3$ , 0, 0);
just_labels bot(0, 1);
just_labels top(3, 4);
just_labels lft(2, 5);
standard_exact_hsbw("less");
end_glyph;

```

Construction of the character equal:

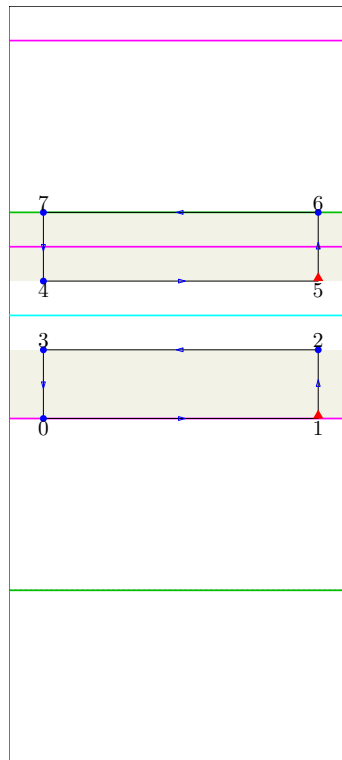

```

encode("equal")(61); standard_introduce("equal");
beginlyph(equal);
 $x_0 = x_3 = x_4 = x_7 = leftstemloc;$ 
 $x_1 - x_0 = x_2 - x_3 = x_5 - x_4 = x_6 - x_7 = 8xu;$ 
 $.5[y_3, y_4] = .5[y_2, y_5] = math\_axis; y_4 - y_3 = y_5 - y_2 = 2xu;$ 
 $y_7 - y_4 = y_6 - y_5 = y_3 - y_0 = y_2 - y_1 = py;$ 
Fill  $z_0 -- z_1 -- z_2 -- z_3 -- cycle, z_4 -- z_5 -- z_6 -- z_7 -- cycle;$ 
fix_hstem( $py$ )(glyph_stored.glyph_name 1);
fix_hstem( $py$ )(glyph_stored.glyph_name 2);
fix_dimens( $x_1 + rightbear, y_6, 0, 0$ );

just_labels bot(0, 1, 4, 5);
just_labels top(2, 3, 6, 7);

standard_exact_hsbw("equal");
endglyph;

```

Construction of the character greater:

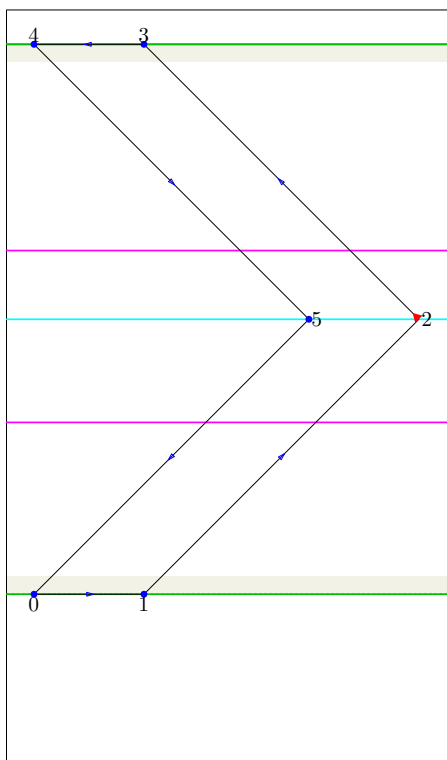

```

encode("greater")(62); standard_introduce("greater");
begin_glyph(greater);
y_0 = y_1 = 0; x_0 = x_4 = leftstemloc - o; y_3 = y_4 = uc_height;
y_5 = y_2 = .5uc_height;
x_1 - x_0 = x_2 - x_5 = x_3 - x_4 = px + o;
x_5 - x_0 = y_5 - y_0;
Fill z_0 -- z_1 -- z_2 -- z_3 -- z_4 -- z_5 -- cycle;
fix_dimens(x_2 + rightbear, y_3, 0, 0);
ghost_stem top, bot;
just_labels bot(0, 1);
just_labels top(3, 4);
just_labels rt(2, 5);
standard_exact_hsbw("greater");
end_glyph;

```

Construction of the character question:

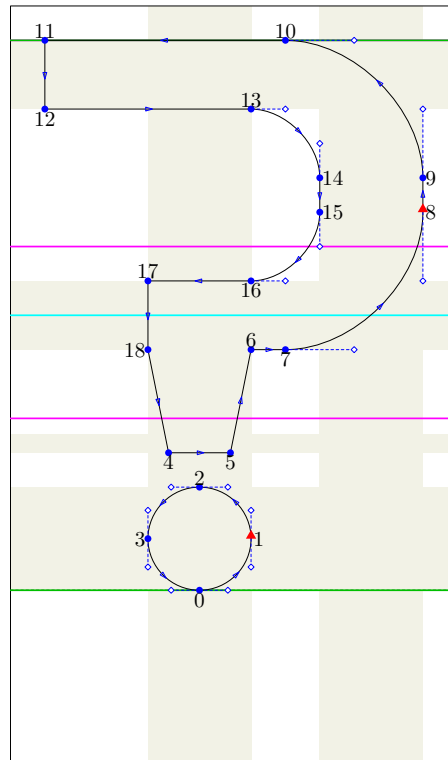

```

encode("question")(63); standard_introduce("question");
beginlyph(question);
y0 = 0; x11 = x12 = leftstemloc; y10 = y11 = uc.height;
x6 - x18 = x8 - x15 = x9 - x14 = x16 - x17 = px = x1 - x3 = y2 - y0;
x2 = x0 = .5[x3, x1] = .5[x18, x6]; y1 = y3 = .5[y2, y0];
y4 - y2 = y5 - y2 = xu; x4 - x18 = x6 - x5 = 3u;
x17 - x12 = 3xu; x7 - x6 = 1xu; x17 = x18; x9 = x8;
.5[y6, y16] = .5[y18, y17] = .5uc.height; y7 = y6;
y17 - y18 = y16 - y7 = y10 - y13 = y11 - y12 = py;
z8 = z7 + (obow, obow); z10 = z9 + (-obow, obow);
z14 = z13 + (ibow, -ibow); z16 = z15 - (ibow, ibow);

Fill z0 .. z1 .. z2 .. z3 .. cycle, z4 -- z5 -- z6 -- crescent right(7, 8)
  -- crescent up(9, 10) -- z11 -- z12 -- bow right(13, 14)
  -- bow down(15, 16) -- z17 -- z18 -- cycle;

fix_vstem(px)(glyph_stored.glyph_name 1,
  glyph_stored.glyph_name 2)(x > leftstemloc);
fix_hstem(px)(glyph_stored.glyph_name 1);
fix_hstem(py)(glyph_stored.glyph_name 1, glyph_stored.glyph_name 2);
fix_dims(x8 + rightbear, y10, 0, 0);

ghost_stem bot(y4);

just_labels bot(0, 4, 5, 7, 12, 16);
just_labels top(2, 6, 10, 11, 13, 17);
just_labels rt(1, 8, 9, 14, 15);
just_labels lft(3, 18);

standard_exact_hsbw("question");
endglyph;

```

Construction of the character at:

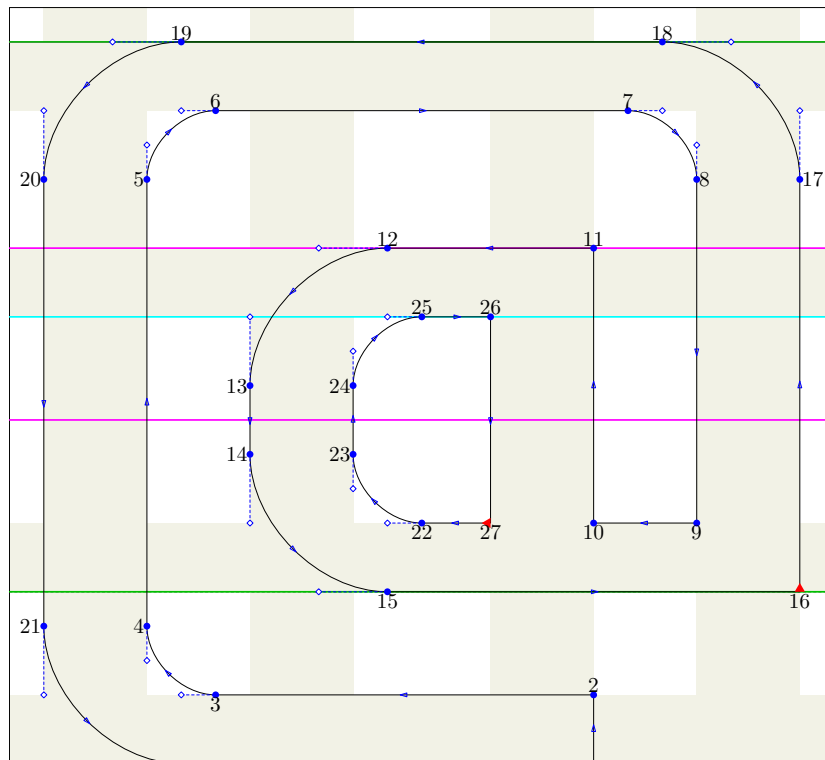

```

encode("at")(64); standard_introduce("at");
beginlyph(at);
y15 = y16 = 0; x20 = x21 = leftstemloc; x4 - x21 = x5 - x20 = x17 - x8 = x16 - x9 = px;
x13 - x5 = x14 - x4 = x8 - x11 = x9 - x10 = 3xu; % Inner a horizontal padding
x2 = x1 = x10; x24 - x13 = x23 - x14 = x11 - x26 = x10 - x27 = px; % Inner a stem width
y2 - y1 = y3 - y0 = y19 - y6 = y18 - y7 = py; x26 - x25 = x27 - x22 = 2xu; % Inner a horizontal size
y16 - y2 = y15 - y3 = 3xu; y6 - y12 = y7 - y11 = 4xu; % Inner a vertical padding
y22 - y15 = y9 - y16 = y12 - y25 = y11 - y26 = py; % Inner a stem height
y27 = y22; y10 = y9; y26 = y25; y24 - y23 = 2xu; %Inner a vertical size
z4 = z3 + (-ibow, ibow); z6 = z5 + (ibow, ibow); z8 = z7 + (ibow, -ibow);
z13 = z12 - (obow, obow); z15 = z14 + (obow, -obow); z18 = z17 + (-obow, obow);
z20 = z19 - (obow, obow); z0 = z21 + (obow, -obow); z23 = z22 + (-ibow, ibow);
z25 = z24 + (ibow, ibow); hv0 := x4; hv1 := x8; hh0 := y2; hh1 := y7;

Fill z0 -- z1 -- z2 -- bow left(3, 4) -- bow up(5, 6) -- bow right(7, 8) -- z9
-- z10 -- z11 -- crescet left(12, 13) -- crescet down(14, 15) -- z16
-- crescet up(17, 18) -- crescet left(19, 20) -- crescet down(21, 0) & cycle;
unFill bow left(22, 23) -- bow up(24, 25) -- z26 -- z27 -- cycle;

fix_vstem(px)(glyph_stored.glyph_name 1)((x <= hv0) or (x >= hv1));
fix_vstem(px)(glyph_stored.glyph_name 1,
glyph_stored.glyph_name 2)((x > hv0) and (x < hv1));
fix_hstem(py)(glyph_stored.glyph_name 1)((y <= hh0) or (y >= hh1));
fix_hstem(py)(glyph_stored.glyph_name 1,
glyph_stored.glyph_name 2)((y > hh0) and (y < hh1));
fix_dimsens(round(x16 + rightbear), y18, 0, 0);

just_labels bot(0, 1, 3, 9, 10, 15, 16, 22, 27);
just_labels top(2, 6, 7, 11, 12, 18, 19, 25, 26);
just_labels rt(8, 17); just_labels lft(4, 5, 13, 14, 20, 21, 23, 24);

standard_exact_hsbw("at");
endglyph;

```

Construction of the character A:

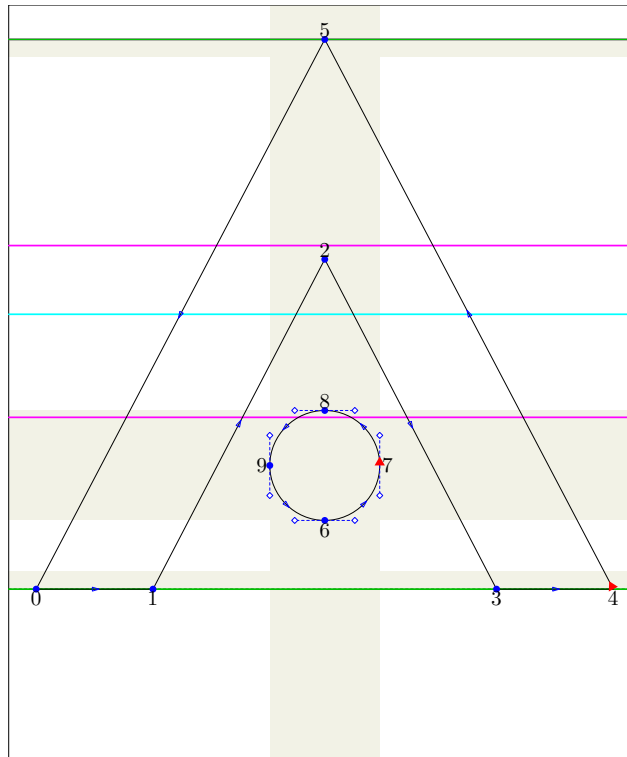

```

encode("A")(65); standard_introduce("A");
beginlyph(A);
 $y_0 = y_1 = y_3 = y_4 = 0$ ;  $x_0 = \text{leftstemloc} - o$ ;  $x_1 - x_0 = x_4 - x_3 = px + u + o$ ;
 $x_2 - x_1 = x_3 - x_2 = 5xu$ ;  $y_5 = \text{uc\_height} = y_2 + 6xu + 2u$ ;

 $x_6 = x_8 = x_2 = x_5$ ;  $y_7 = y_9 = \text{dotheight}$ ;  $y_8 - y_6 = x_7 - x_9 = px + u$ ;
 $x_8 = .5[x_9, x_7]$ ;  $y_9 = .5[y_6, y_8]$ ;

Fill  $z_0 \text{ -- } z_1 \text{ -- } z_2 \text{ -- } z_3 \text{ -- } z_4 \text{ -- } z_5 \text{ -- cycle}$ ,  $z_6 \dots z_7 \dots z_8 \dots z_9 \dots \text{cycle}$ ;

fix_vstem( $px + u$ )(glyph_stored.glyph_name 2);
fix_hstem( $px + u$ )(glyph_stored.glyph_name 2);
ghost_stem top, bot;
fix_dimens( $x_4 + \text{rightbear} - o$ ,  $y_5$ , 0, 0);

just_labels bot(0, 1, 3, 4, 6); just_labels top(2, 5, 8);
just_labels lt(9); just_labels rt(7);

standard_exact_hsbw("A");
endglyph;

```

Construction of the character B:

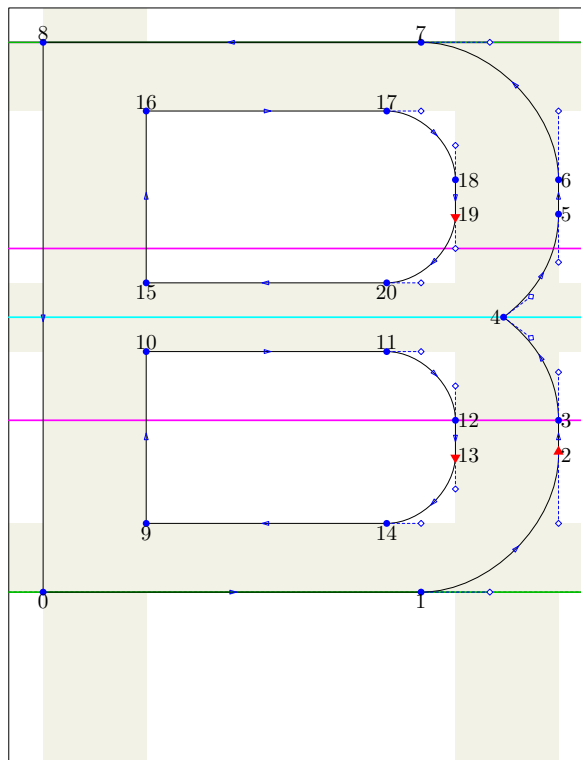

```

encode("B")(66); standard_introduce("B");
beginlyph(B);
y0 = y1 = 0; y7 = y8 = uc_height; x0 = x8 = leftstemloc;
x14 - x9 = x20 - x15 = x17 - x16 = 7xu; x9 - x0 = x10 - x0 = x15 - x8 = x16 - x8 = px;
x3 - x12 = x2 - x13 = x5 - x19 = x6 - x18 = px;
y4 - y3 = y5 - y4 = obow - .5py; x3 - x4 = x5 - x4 = .4obow;
.5[y10, y15] = .5[y11, y20] = y4 = .5uc_height;
y9 - y0 = y14 - y1 = y8 - y16
= y7 - y17 = y15 - y10 = y20 - y11 = py;
z2 = z1 + (obow, obow); z7 = z6 + (-obow, obow); z14 = z13 - (ibow, ibow);
z11 = z12 + (-ibow, ibow); z20 = z19 - (ibow, ibow); z17 = z18 + (-ibow, ibow);

Fill z0 -- crescent right(1, 2) -- bay up(3, 4) & bay right(4, 5)
  -- crescent up(6, 7) -- z8 -- cycle;
unFill z9 -- z10 -- bow right(11, 12) -- bow down(13, 14) -- cycle,
  z15 -- z16 -- bow right(17, 18) -- bow down(19, 20) -- cycle;

fix_vstem(px)(glyph_stored.glyph_name 1, glyph_stored.glyph_name 2,
  glyph_stored.glyph_name 3);
fix_hstem(py)(glyph_stored.glyph_name 1, glyph_stored.glyph_name 2,
  glyph_stored.glyph_name 3);
fix_dimens(x2 + rightbear, y7, 0, 0);

just_labels bot(0, 1, 9, 14, 15, 20);
just_labels top(7, 8, 10, 11, 16, 17);
just_labels rt(2, 3, 5, 6, 12, 13, 18, 19);
just_labels lft(4);
standard_exact_hsbw("B");
endglyph;

```

Construction of the character C:

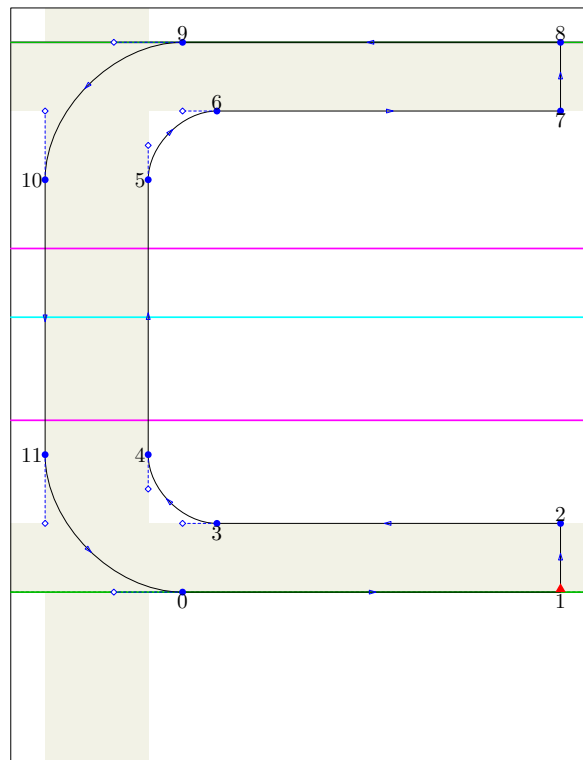

```

encode("C")(67); standard_introduce("C");
beginglyph(C);
 $y_0 = y_1 = 0; x_{11} = x_{10} = \text{leftstemloc}; y_8 = y_9 = \text{uc\_height};$ 
 $x_7 - x_6 = x_2 - x_3 = 10xu; x_2 = x_1; x_8 = x_7;$ 
 $x_4 - x_{11} = x_5 - x_{10} = px; y_2 - y_1 = y_3 - y_0 = y_8 - y_7 = y_9 - y_6 = py;$ 
 $z_0 = z_{11} + (\text{obow}, -\text{obow}); z_{10} = z_9 + (-\text{obow}, -\text{obow});$ 
 $z_4 = z_3 + (-\text{ibow}, \text{ibow}); z_6 = z_5 + (\text{ibow}, \text{ibow});$ 

Fill  $z_0$  --  $z_1$  --  $z_2$  -- bow left(3, 4) -- bow up(5, 6) --  $z_7$  --  $z_8$ 
  -- crescent left(9, 10) -- crescent down(11, 0) & cycle;

fix_vstem( $px$ )(glyph_stored.glyph_name 1);
fix_hstem( $py$ )(glyph_stored.glyph_name 1);
fix_dimens( $x_1 + \text{rightbear}$ ,  $y_8$ , 0, 0);

just_labels bot(0, 1, 3, 7);
just_labels top(2, 6, 8, 9);
just_labels lft(4, 5, 10, 11);
standard_exact_hsbw("C");
endglyph;

```

Construction of the character D:

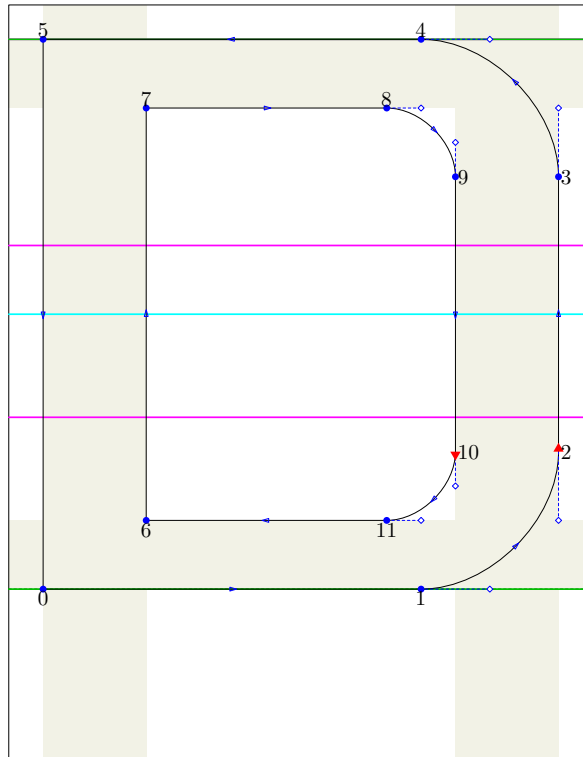

```

encode("D")(68); standard_introduce("D");
beginlyph(D);
 $y_0 = y_1 = 0; x_0 = x_5 = \text{leftstemloc}; y_4 = y_5 = \text{uc\_height};$ 
 $x_6 - x_0 = x_7 - x_5 = x_3 - x_9 = x_2 - x_{10} = px; x_{11} - x_6 = x_8 - x_7 = 7xu;$ 
 $y_6 - y_0 = y_{11} - y_1 = y_5 - y_7 = y_4 - y_8 = py;$ 
 $z_2 = z_1 + (\text{obow}, \text{obow}); z_4 = z_3 + (-\text{obow}, \text{obow});$ 
 $z_9 = z_8 + (\text{ibow}, -\text{ibow}); z_{11} = z_{10} + (-\text{ibow}, -\text{ibow});$ 

Fill  $z_0$  -- crescent right(1, 2) -- crescent up(3, 4) --  $z_5$  -- cycle;
unFill  $z_6$  --  $z_7$  -- bow right(8, 9) -- bow down(10, 11) -- cycle;

fix_vstem( $px$ )(glyph_stored.glyph_name 1, glyph_stored.glyph_name 2);
fix_hstem( $py$ )(glyph_stored.glyph_name 1, glyph_stored.glyph_name 2);
fix_dimens( $x_2 + \text{rightbear}, y_4, 0, 0$ );

just_labels bot(0, 1, 6, 11);
just_labels top(4, 5, 7, 8);
just_labels rt(2, 3, 9, 10);
standard_exact_hsbw("D");
endglyph;

```

Construction of the character E:

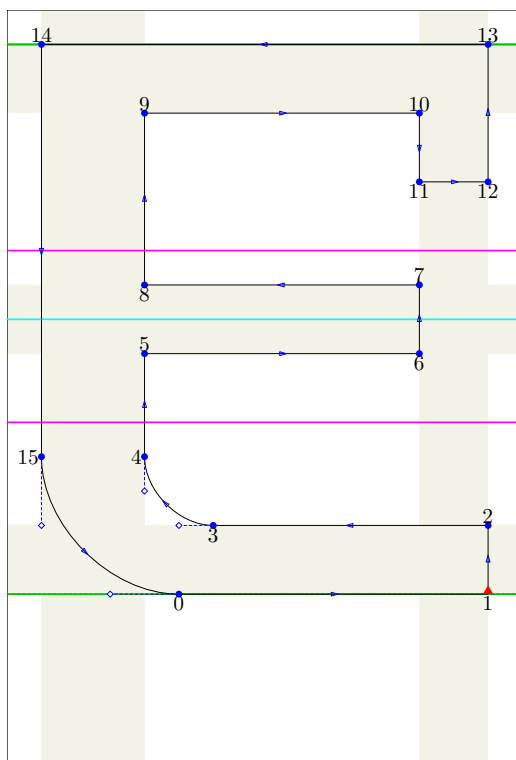

```

encode("E")(69); standard_introduce("E");
beginglyph(E);
y0 = y1 = 0; x14 = x15 = leftstemloc; y13 = y14 = uc.height;
x6 - x5 = x7 - x8 = x10 - x9 = 8xu; x10 = x11;
x2 - x6 = x12 - x11 = x13 - x10 = xgap; x1 = x2;
x4 - x15 = x5 - x15 = x8 - x14 = x9 - x14 = px;
.5[y5, y8] = .5[y6, y7] = .5uc.height;
y7 - y6 = y8 - y5 = y2 - y1 = y3 - y0
= y14 - y9 = y13 - y10 = py; y10 - y11 = 2xu; y12 = y11;
z0 = z15 + (obow, -obow); z4 = z3 + (-ibow, ibow);
hh0 := y11; hh1 := y9;

Fill z0 -- z1 -- z2 -- bow left(3, 4) -- z5 -- z6 -- z7 -- z8 -- z9 -- z10 -- z11 -- z12
-- z13 -- z14 -- crescent down(15, 0) & cycle;

fix_vstem(px)(glyph_stored.glyph_name 1);
fix_vstem(xgap)(glyph_stored.glyph_name 1);
fix_hstem(py)(glyph_stored.glyph_name 1)((y < hh0) or (y >= hh1));
fix_dims(x1 + rightbear, y13, 0, 0);

just_labels bot(0, 1, 3, 6, 8, 11, 12);
just_labels top(2, 5, 7, 9, 10, 13, 14);
just_labels lft(4, 15);
standard_exact_hsbw("E");
endglyph;

```

Construction of the character F:

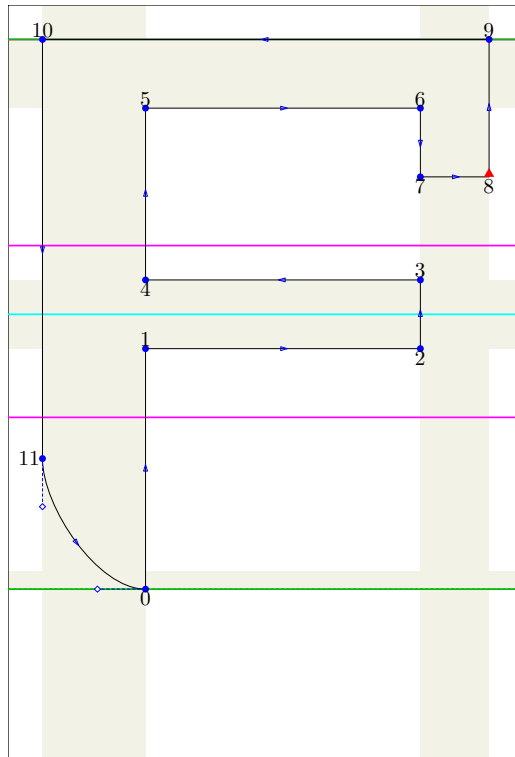

```

encode("F")(70); standard_introduce("F");
beginlyph(F);
 $y_0 = 0; x_{10} = x_{11} = \text{leftstemloc}; y_9 = y_{10} = \text{uc\_height};$ 
 $x_0 - x_{11} = x_1 - x_{11} = x_4 - x_{10} = x_5 - x_{10} = px;$ 
 $x_2 - x_1 = x_3 - x_4 = x_6 - x_5 = 8xu; x_7 = x_6;$ 
 $x_8 - x_7 = x_9 - x_6 = \text{xgap};$ 
 $.5[y_1, y_4] = .5[y_2, y_3] = .5\text{uc\_height};$ 
 $y_3 - y_2 = y_4 - y_1 = y_{10} - y_5 = y_9 - y_6 = py;$ 
 $y_6 - y_7 = 2xu; y_8 = y_7; y_{11} - y_0 = \text{lbow};$ 
 $hh_0 := y_7; hh_1 := y_5;$ 

Fill  $z_0$  --  $z_1$  --  $z_2$  --  $z_3$  --  $z_4$  --  $z_5$  --  $z_6$  --  $z_7$  --  $z_8$  --  $z_9$  --  $z_{10}$ 
  -- stem_crescent(11, 0) & cycle;

fix_vstem( $px$ )(glyph_stored.glyph_name 1);
fix_vstem( $x_{\text{gap}}$ )(glyph_stored.glyph_name 1);
fix_hstem( $py$ )(glyph_stored.glyph_name 1)(( $y < hh_0$ ) or ( $y \geq hh_1$ ));
fix_dimens( $x_8 + \text{rightbear}$ ,  $y_9$ , 0, 0);
ghost_stem bot;

just_labels bot(0, 2, 4, 7, 8);
just_labels top(1, 3, 5, 6, 9, 10);
just_labels lft(11);
standard_exact_hsbw("F");
endglyph;

```

Construction of the character G:

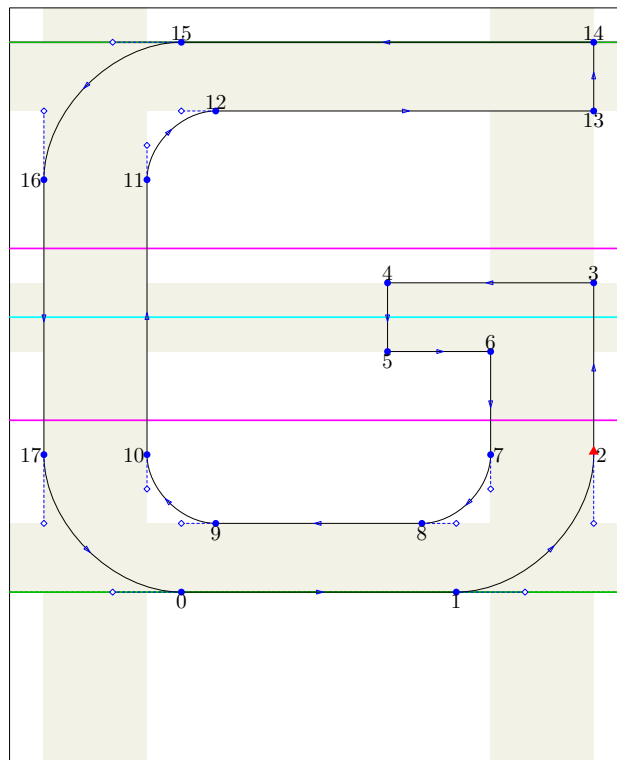

```

encode("G")(71); standard_introduce("G");
beginlyph(G);
 $y_0 = y_1 = 0; x_{16} = x_{17} = \text{leftstemloc}; y_{14} = y_{15} = \text{uc.height};$ 
 $x_{10} - x_{17} = x_{11} - x_{16} = x_2 - x_7 = x_3 - x_6 = px; x_8 - x_9 = 6xu;$ 
 $x_{13} = x_{14} = x_3; x_6 = x_7; x_6 - x_5 = 3xu; x_4 = x_5;$ 
 $y_8 - y_1 = y_9 - y_0 = y_{15} - y_{12} = y_{14} - y_{13} = y_4 - y_5 = y_3 - y_6 = py;$ 
 $.5[y_5, y_4] = .5[y_6, y_3] = .5\text{uc.height};$ 

 $z_0 = z_{17} + (\text{obow}, -\text{obow}); z_2 = z_1 + (\text{obow}, \text{obow}); z_{16} = z_{15} - (\text{obow}, \text{obow});$ 
 $z_8 = z_7 - (\text{ibow}, \text{ibow}); z_{10} = z_9 + (-\text{ibow}, \text{ibow}); z_{12} = z_{11} + (\text{ibow}, \text{ibow});$ 
 $hv_0 := x_4; hv_1 := x_6;$ 

Fill  $z_0$  -- crescent right(1, 2) --  $z_3$  --  $z_4$  --  $z_5$  --  $z_6$  -- bow down(7, 8)
  -- bow left(9, 10) -- bow up(11, 12) --  $z_{13}$  --  $z_{14}$  -- crescent left(15, 16)
  -- crescent down(17, 0) & cycle;

fix_vstem( $px$ )(glyph_stored.glyph_name 1)(( $x < hv_0$ ) or ( $x \geq hv_1$ ));
fix_hstem( $py$ )(glyph_stored.glyph_name 1);
fix_dimens( $x_2 + \text{rightbear}$ ,  $y_{14}$ , 0, 0);
just_labels bot(0, 1, 5, 8, 9, 13);
just_labels top(3, 4, 6, 12, 14, 15);
just_labels rt(2, 7);
just_labels lft(10, 11, 16, 17);

standard_exact_hsbw("G");
endglyph;

```

Construction of the character H:

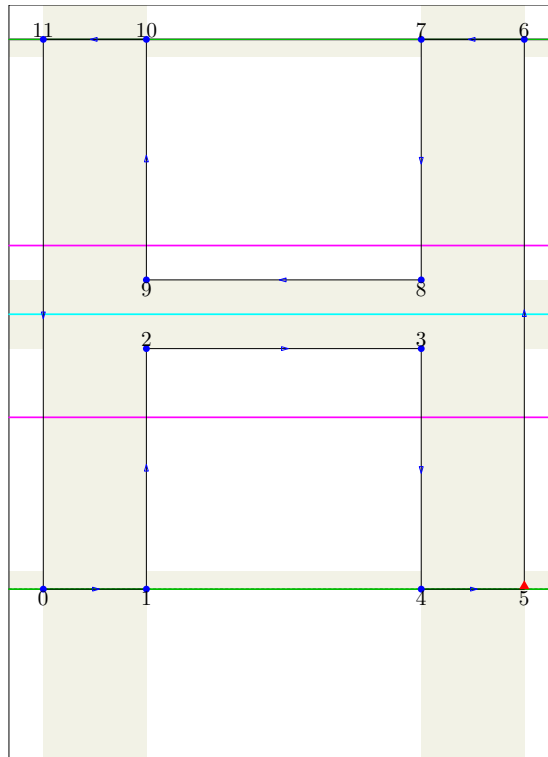

```

encode("H")(72); standard_introduce("H");
beginglyph(H);
 $y_0 = y_1 = y_4 = y_5 = 0$ ;  $x_0 = x_{11} = \text{leftstemloc}$ ;  $y_6 = y_7 = y_{10} = y_{11} = \text{uc\_height}$ ;
 $.5[y_2, y_9] = .5[y_3, y_8] = .5\text{uc\_height}$ ;  $y_9 - y_2 = y_8 - y_3 = py$ ;
 $x_1 - x_0 = x_2 - x_0 = x_9 - x_{11} = x_{10} - x_{11}$ 
 $= x_6 - x_7 = x_5 - x_4 = x_5 - x_3 = x_6 - x_8 = px$ ;
 $x_3 - x_2 = x_8 - x_9 = 8xu$ ;
Fill  $z_0 \text{ -- } z_1 \text{ -- } z_2 \text{ -- } z_3 \text{ -- } z_4 \text{ -- } z_5 \text{ -- } z_6 \text{ -- } z_7 \text{ -- } z_8 \text{ -- } z_9 \text{ -- } z_{10} \text{ -- } z_{11} \text{ -- cycle}$ ;

fix_vstem( $px$ )(glyph_stored.glyph_name 1);
fix_hstem( $py$ )(glyph_stored.glyph_name 1);
fix_dimens( $x_5 + \text{rightbear}$ ,  $y_6$ , 0, 0);
just_labels bot(0, 1, 4, 5, 8, 9);
just_labels top(2, 3, 6, 7, 10, 11);
ghost_stem top, bot;

standard_exact_hsbw("H");
endglyph;

```

Construction of the character I:

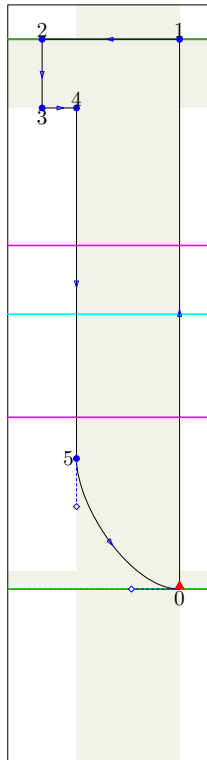

```

encode("I")(73); standard_introduce("I");
beginglyph(I);
 $y_0 = 0$ ;  $x_2 = x_3 = \textit{leftstemloc}$ ;  $y_1 = y_2 = \textit{uc\_height}$ ;
 $x_4 - x_3 = \textit{xu}$ ;  $x_5 = x_4$ ;  $x_1 - x_4 = x_0 - x_5 = \textit{px}$ ;
 $y_2 - y_3 = y_1 - y_4 = \textit{py}$ ;  $y_5 - y_0 = \textit{lbow}$ ;

Fill  $z_0$  --  $z_1$  --  $z_2$  --  $z_3$  --  $z_4$  --  $\textit{stem\_crescent}(5, 0)$  & cycle;

fix_vstem( $\textit{px}$ )( $\textit{glyph\_stored.glyph\_name}$  1);
fix_hstem( $\textit{py}$ )( $\textit{glyph\_stored.glyph\_name}$  1);
fix_dimens( $x_0 + \textit{rightbear}$ ,  $y_1$ , 0, 0);
ghost_stem  $\textit{bot}$ ;

just_labels  $\textit{bot}(0, 3)$ ;
just_labels  $\textit{top}(1, 2, 4)$ ;
just_labels  $\textit{lft}(5)$ ;

standard_exact_hsbw("I");
endglyph;

```

Construction of the character J:

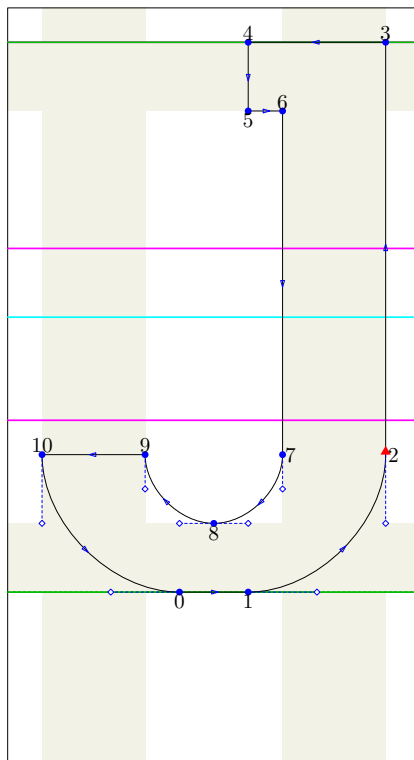

```

encode("J")(74); standard_introduce("J");
beginlyph(J);
 $y_0 = y_1 = 0; x_{10} = \text{leftstemloc}; y_3 = y_4 = \text{uc\_height};$ 
 $x_2 - x_7 = x_9 - x_{10} = x_3 - x_6 = px; x_7 = x_6; x_6 - x_5 = 1xu; x_4 = x_5;$ 
 $y_8 - y_0 = y_4 - y_5 = y_3 - y_6 = py;$ 
 $z_0 = z_{10} + (\text{obow}, -\text{obow}); z_2 = z_1 + (\text{obow}, \text{obow}); z_8 = z_7 - (\text{ibow}, \text{ibow}); z_9 = z_8 + (-\text{ibow}, \text{ibow});$ 
 $hh_0 := y_8; hh_1 := y_9; hv_0 := x_9; hv_1 := x_4;$ 

Fill  $z_0$  -- crescent right(1, 2) --  $z_3$  --  $z_4$  --  $z_5$  --  $z_6$  -- bow down(7, 8)
    & bow left(8, 9) -- crescent down(10, 0) & cycle;

fix_vstem( $px$ )(glyph_stored.glyph_name 1)(( $x \leq hv_0$ ) or ( $x > hv_1$ ));
fix_hstem( $py$ )(glyph_stored.glyph_name 1)(( $y \leq hh_0$ ) or ( $y > hh_1$ ));
fix_dimens( $x_2 + \text{rightbear}, y_3, 0, 0$ );

just_labels bot(0, 1, 5, 8);
just_labels top(3, 4, 6, 9, 10);
just_labels rt(2, 7);

standard_exact_hsbw("J");
endglyph;

```

Construction of the character K:

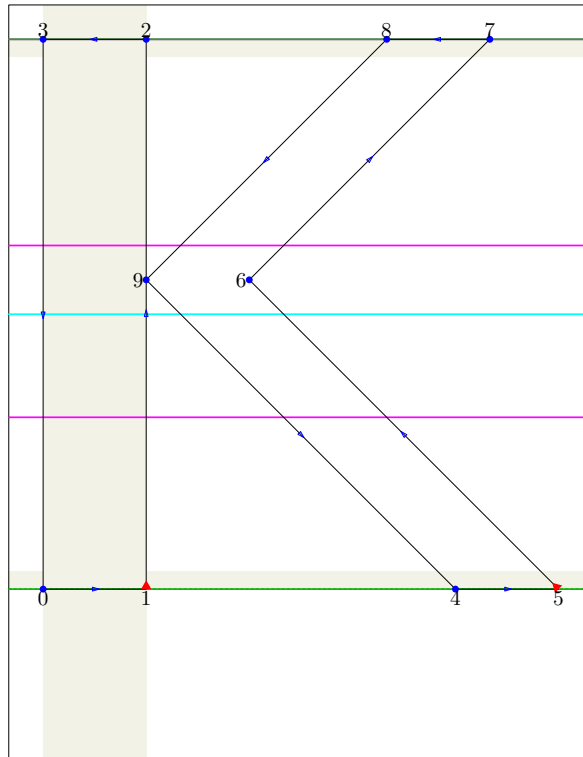

```

encode("K")(75); standard_introduce("K");
beginlyph(K);
 $y_0 = y_1 = y_4 = y_5 = 0; x_0 = x_3 = \text{leftstemloc}; y_2 = y_3 = y_7 = y_8 = \text{uc\_height};$ 
 $x_1 - x_0 = x_2 - x_3 = x_5 - x_4 = x_6 - x_9 = x_7 - x_8 = px;$ 
 $z_9 = z_8 - (7xu, 7xu); x_4 - x_9 = 9xu; y_6 = y_9; x_9 = x_1;$ 

Fill  $z_0 \text{ -- } z_1 \text{ -- } z_2 \text{ -- } z_3 \text{ -- cycle, } z_4 \text{ -- } z_5 \text{ -- } z_6 \text{ -- } z_7 \text{ -- } z_8 \text{ -- } z_9 \text{ -- cycle};$ 

fix_vstem( $px$ )( $\text{glyph\_stored.glyph\_name } 1$ );
ghost_stem  $\text{bot, top};$ 
fix_dimens( $x_5 + \text{rightbear, } y_7, 0, 0$ );

just_labels  $\text{bot}(0, 1, 4, 5);$ 
just_labels  $\text{flt}(6, 9);$ 
just_labels  $\text{top}(2, 3, 7, 8);$ 

standard_exact_hsbw("K");
endglyph;

```

Construction of the character L:

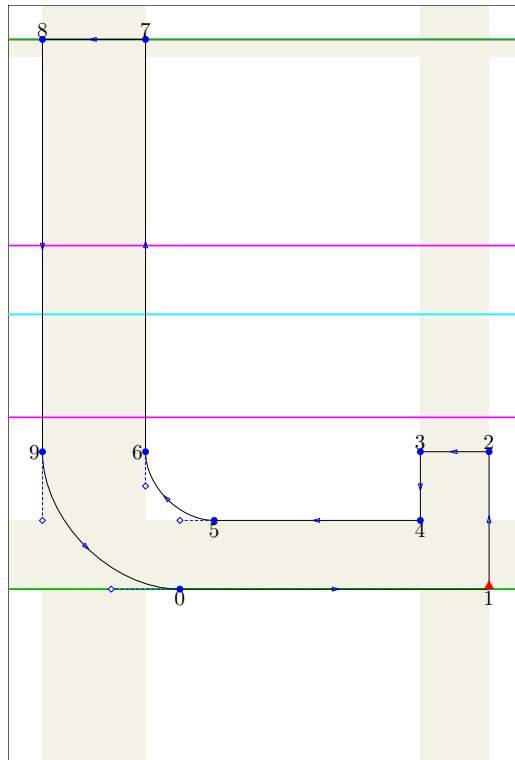

```

encode("L")(76); standard_introduce("L");
beginglyph(L);
y0 = y1 = 0; x8 = x9 = leftstemloc; y7 = y8 = uc_height;
x7 - x8 = x6 - x9 = px; x4 - x5 = 6xu; x3 = x4; x2 - x3 = x1 - x4 = xgap;
y4 - y1 = y5 - y0 = py; y3 - y4 = 2xu; y2 = y3;
z0 = z9 + (obow, -obow); z6 = z5 + (-ibow, ibow);
hh0 := y4; hh1 := y2;

Fill z0 -- z1 -- z2 -- z3 -- z4 -- bow left(5, 6) -- z7 -- z8
-- crest down(9, 0) & cycle;

fix_vstem(px)(glyph_stored.glyph_name 1);
fix_vstem(xgap)(glyph_stored.glyph_name 1);
fix_hstem(py)(glyph_stored.glyph_name 1)((y <= hh0) or (y > hh1));
ghost_stem top;
fix_dimens(x1 + rightbear, y7, 0, 0);

just_labels bot(0, 1, 4, 5);
just_labels lft(6, 9);
just_labels top(2, 3, 7, 8);

standard_exact_hsbw("L");
endglyph;

```

Construction of the character Lslash:

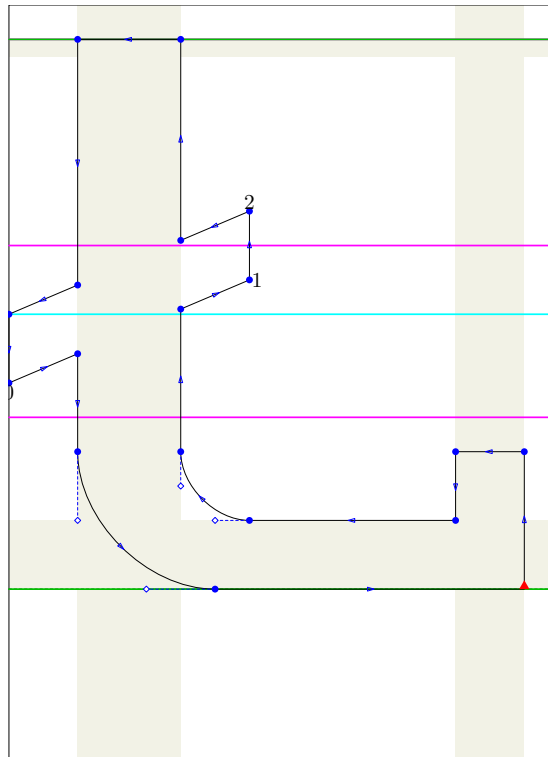

```

encode("Lslash")(28); standard_introduce("Lslash");
beginlyph(Lslash);
 $x_0 = x_3 = \text{leftstemloc} - xu; y_3 = .5uc\_height;$ 
 $x_2 - x_3 = x_1 - x_0 = px + 2xu + 2xu;$ 
 $y_3 - y_0 = y_2 - y_1 = py; y_1 - y_3 = xu;$ 
find_outlines(glyph_stored.L 1 shifted (xu, 0),
   $z_0 \text{ -- } z_1 \text{ -- } z_2 \text{ -- } z_3 \text{ -- cycle}$ )(glyph);
Fill glyph1;
use_stems(L)(xu, 0);
fix_dimens(wd.L + xu, ht.L, 0, 0);
just_labels bot(0);
just_labels rt(1);
just_labels top(2);
just_labels lft(3);
standard_exact_hsbw("Lslash");
endglyph;

```

Construction of the character M:

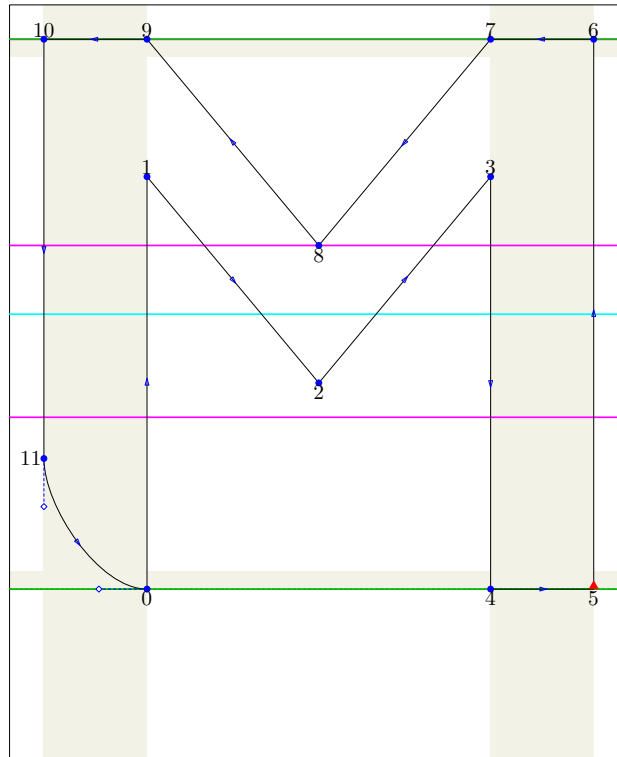

```

encode("M")(77); standard_introduce("M");
beginlyph(M);
 $y_0 = y_4 = y_5 = 0; x_{10} = x_{11} = \text{leftstemloc}; y_6 = y_7 = y_9 = y_{10} = \text{uc\_height};$ 
 $x_0 - x_{11} = x_1 - x_{10} = x_9 - x_{10} = x_5 - x_4 = x_6 - x_3 = x_6 - x_7 = px;$ 
 $x_2 - x_1 = x_7 - x_8 = 5xu; x_3 = x_4; x_2 = x_8;$ 
 $y_9 - y_1 = y_8 - y_2 = y_7 - y_3 = 2py; y_9 - y_8 = 6xu;$ 
 $y_{11} = y_0 + \text{lbow};$ 

Fill  $z_0$  --  $z_1$  --  $z_2$  --  $z_3$  --  $z_4$  --  $z_5$  --  $z_6$  --  $z_7$  --  $z_8$  --  $z_9$  --  $z_{10}$ 
  -- stem_crescent(11, 0) & cycle;

fix_vstem( $px$ )(glyph_stored.glyph_name 1);
ghost_stem top, bot;
fix_dimens( $x_5 + \text{rightbear}$ ,  $y_6$ , 0, 0);

just_labels bot(0, 2, 4, 5, 8);
just_labels lft(11);
just_labels top(1, 3, 6, 7, 9, 10);

standard_exact_hsbw("M");
endglyph;

```

Construction of the character N:

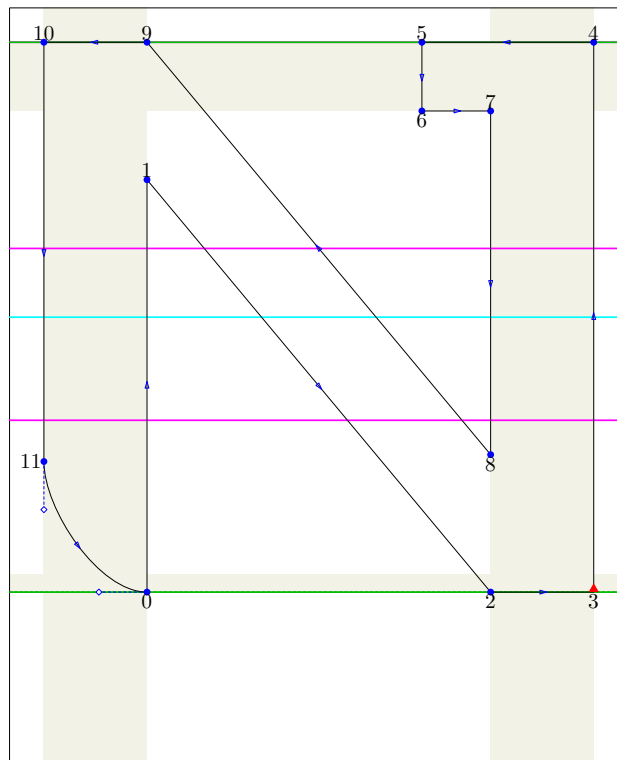

```

encode("N")(78); standard_introduce("N");
beginlyph(N);
 $y_0 = y_2 = y_3 = 0; x_{10} = x_{11} = \text{leftstemloc}; y_4 = y_5 = y_9 = y_{10} = \text{uc\_height};$ 
 $x_0 - x_{11} = x_1 - x_{10} = x_9 - x_{10} = x_3 - x_2 = x_3 - x_8 = x_4 - x_7 = px; x_8 = x_7;$ 
 $x_2 - x_1 = 10xu; x_7 - x_6 = \text{xgap}; x_5 = x_6; y_5 - y_6 = y_4 - y_7 = 2xu;$ 
 $y_9 - y_1 = y_8 - y_2 = 2py; y_{11} = y_0 + \text{lbow};$ 

Fill  $z_0$  --  $z_1$  --  $z_2$  --  $z_3$  --  $z_4$  --  $z_5$  --  $z_6$  --  $z_7$  --  $z_8$  --  $z_9$  --  $z_{10}$ 
  -- stem_crescent(11, 0) & cycle;

fix_vstem( $px$ )(glyph_stored.glyph_name 1);
fix_hstem( $2xu$ )(glyph_stored.glyph_name 1);
ghost_stem bot;
fix_dimens( $x_3 + \text{rightbear}$ ,  $y_4$ , 0, 0);
just_labels bot(0, 2, 3, 6, 8);
just_labels lft(11);
just_labels top(1, 4, 5, 7, 9, 10);

standard_exact_hsbw("N");

endglyph;

```

Construction of the character O:

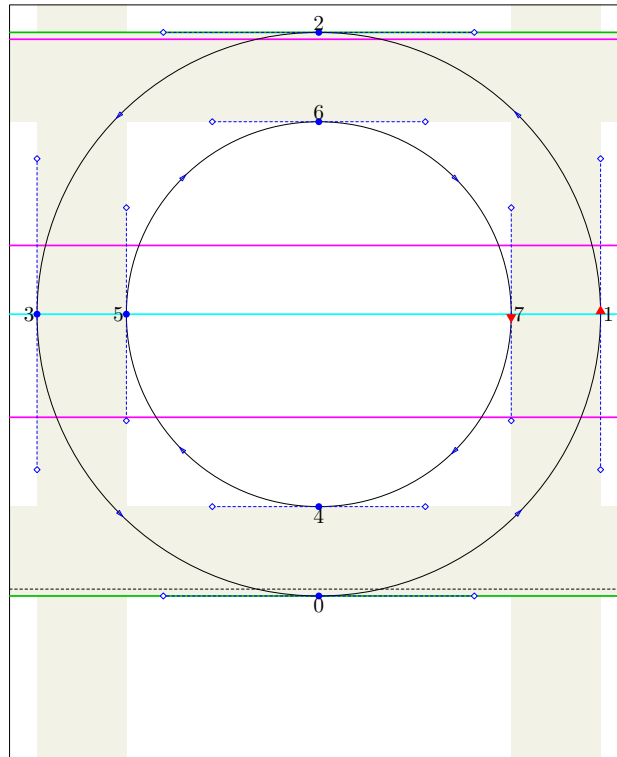

```

encode("0")(79); standard_introduce("0");
beginglyph(O);
 $y_0 = -o$ ;  $x_3 = leftstemloc - o$ ;  $y_2 = uc\_height + o$ ;  $x_1 - x_3 = y_2 - y_0$ ;
 $y_4 - y_0 = x_1 - x_7 = y_2 - y_6 = x_5 - x_3 = o + .48(py + px)$ ;  $y_3 = y_5 = y_7 = y_1 = .5[y_2, y_0]$ ;
 $x_2 = x_6 = x_4 = x_0 = .5[x_1, x_3]$ ;

Fill  $z_0 \dots z_1 \dots z_2 \dots z_3 \dots$  cycle;
unFill  $z_4 \dots z_5 \dots z_6 \dots z_7 \dots$  cycle;

fix_vstem( $o + .48(py + px)$ )(glyph_stored.glyph_name 1, glyph_stored.glyph_name 2);
fix_hstem( $o + .48(py + px)$ )(glyph_stored.glyph_name 1, glyph_stored.glyph_name 2);
fix_dimens( $x_1 + rightbear - o, y_2, y_0, 0$ );
just_labels bot(0, 4);
just_labels rt(1, 7);
just_labels top(2, 6);
just_labels lft(3, 5);

standard_exact_hsbw("0");
endglyph;

```

Construction of the character `Oopenbaseleft`:

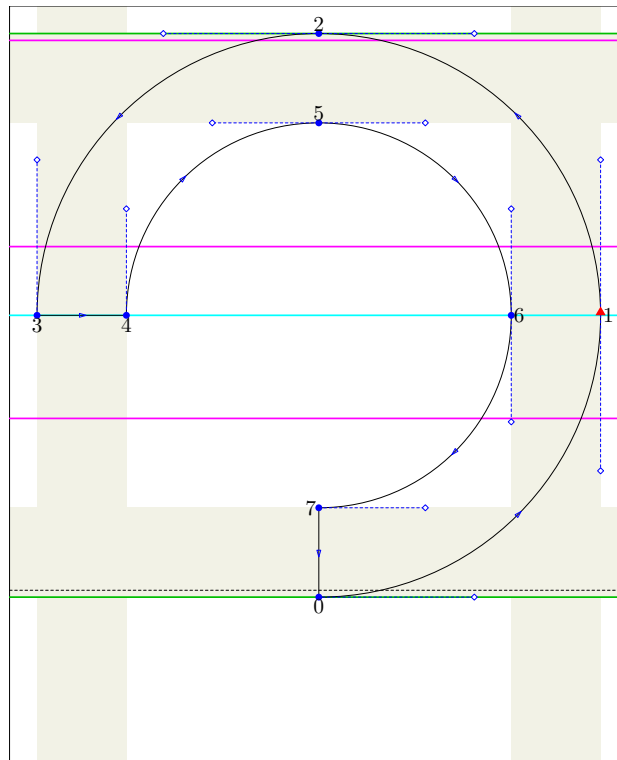

```

standard_introduce("Oopenbaseleft");
beginglyph(Oopenbaseleft);
 $y_0 = -o$ ;  $x_3 = leftstemloc - o$ ;  $y_2 = uc\_height + o$ ;  $x_1 - x_3 = y_2 - y_0$ ;
 $y_7 - y_0 = x_1 - x_6 = y_2 - y_5 = x_4 - x_3 = o + .48(py + px)$ ;  $y_3 = y_4 = y_6 = y_1 = .5[y_2, y_0]$ ;
 $x_2 = x_5 = x_7 = x_0 = .5[x_1, x_3]$ ;

Fill  $z_0 \dots z_1 \dots z_2 \dots z_3$  &  $z_3 \text{ -- } z_4$  &  $z_4 \dots z_5 \dots z_6 \dots z_7$  &  $z_7 \text{ -- cycle}$ ;

fix_vstem( $o + .48(py + px)$ )(glyph_stored.glyph_name 1);
fix_hstem( $o + .48(py + px)$ )(glyph_stored.glyph_name 1);
fix_dimens( $x_1 + rightbear - o, y_2, y_0, 0$ );

just_labels bot(0, 3, 4);
just_labels rt(1, 6);
just_labels lft(7);
just_labels top(2, 5);

standard_exact_hsbw("Oopenbaseleft");
endglyph;

```

Construction of the character P:

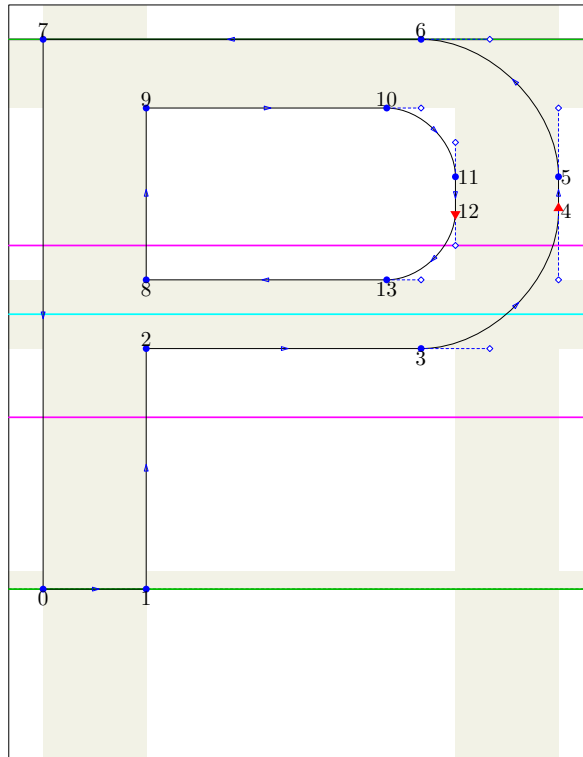

```

encode("P")(80); standard_introduce("P");
beginlyph(P);
 $y_0 = y_1 = 0; x_0 = x_7 = \text{leftstemloc}; y_6 = y_7 = \text{uc\_height};$ 
 $x_1 - x_0 = x_2 - x_0 = x_8 - x_7 = x_9 - x_7 = x_4 - x_{12} = x_5 - x_{11} = px; x_{13} - x_8 = x_{10} - x_9 = 7xu;$ 
 $.5[y_2, y_8] = .5[y_3, y_{13}] = .5\text{uc\_height}; y_8 - y_2 = y_{13} - y_3 = y_7 - y_9 = y_6 - y_{10} = py;$ 
 $z_6 = z_5 + (-\text{obow}, \text{obow}); z_4 = z_3 + (\text{obow}, \text{obow}); z_{13} = z_{12} - (\text{ibow}, \text{ibow});$ 
 $z_{11} = z_{10} + (\text{ibow}, -\text{ibow});$ 
Fill  $z_0$  --  $z_1$  --  $z_2$  -- crescent right(3, 4) -- crescent up(5, 6) --  $z_7$  -- cycle;
unFill  $z_8$  --  $z_9$  -- bow right(10, 11) -- bow down(12, 13) -- cycle;

fix_vstem( $px$ )(glyph_stored.glyph_name 1, glyph_stored.glyph_name 2);
fix_hstem( $py$ )(glyph_stored.glyph_name 1, glyph_stored.glyph_name 2);
fix_dimens( $x_4 + \text{rightbear}$ ,  $y_6$ , 0, 0);
ghost_stem bot;

just_labels bot(0, 1, 3, 8, 13);
just_labels top(2, 6, 7, 9, 10);
just_labels rt(4, 5, 11, 12);

standard_exact_hsbw("P");
endglyph;

```

Construction of the character Q:

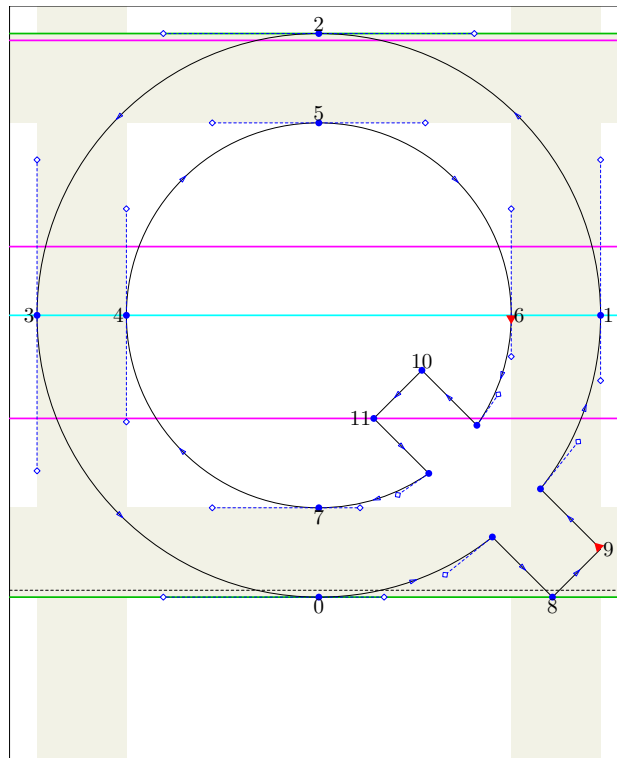

```

encode("Q")(81); standard_introduce("Q");
beginglyph(Q);
 $y_0 = -o$ ;  $x_3 = \text{leftstemloc} - o$ ;  $y_2 = \text{uc\_height} + o$ ;  $x_1 - x_3 = y_2 - y_0$ ;
 $y_7 - y_0 = x_1 - x_6 = y_2 - y_5 = x_4 - x_3 = o + .48(py + px)$ ;  $y_3 = y_4 = y_6 = y_1 = .5[y_2, y_0]$ ;
 $x_2 = x_5 = x_7 = x_0 = .5[x_1, x_3]$ ;
 $y_8 = y_0$ ;  $x_9 = x_1$ ;  $z_9 = z_8 + (7u, 7u)$ ;  $z_9 - z_{10} = z_8 - z_{11} = (5xu + u, -5xu - u)$ ;
find_outlines( $z_0 \dots z_1 \dots z_2 \dots z_3 \dots \text{cycle}$ ,  $z_8 \text{ -- } z_9 \text{ -- } z_{10} \text{ -- } z_{11} \text{ -- cycle}$ )(glypha);
find_outlines(reverse( $z_4 \dots z_5 \dots z_6 \dots z_7 \dots \text{cycle}$ ),
  reverse( $z_8 \text{ -- } z_9 \text{ -- } z_{10} \text{ -- } z_{11} \text{ -- cycle}$ ))(glyphb);
Fill glypha1;
unFill reverse glyphb1;
fix_vstem( $o + .48(py + px)$ )(glyph_stored.glyph_name 1, glyph_stored.glyph_name 2);
fix_hstem( $o + .48(py + px)$ )(glyph_stored.glyph_name 1, glyph_stored.glyph_name 2);
fix_dimens( $x_1 + \text{rightbear} - o$ ,  $y_2$ ,  $y_0$ , 0);

just_labels bot(0, 7, 8);
just_labels rt(1, 6, 9);
just_labels top(2, 5, 10);
just_labels lft(3, 4, 11);

standard_exact_hsbw("Q");
endglyph;

```

Construction of the character Qwave:

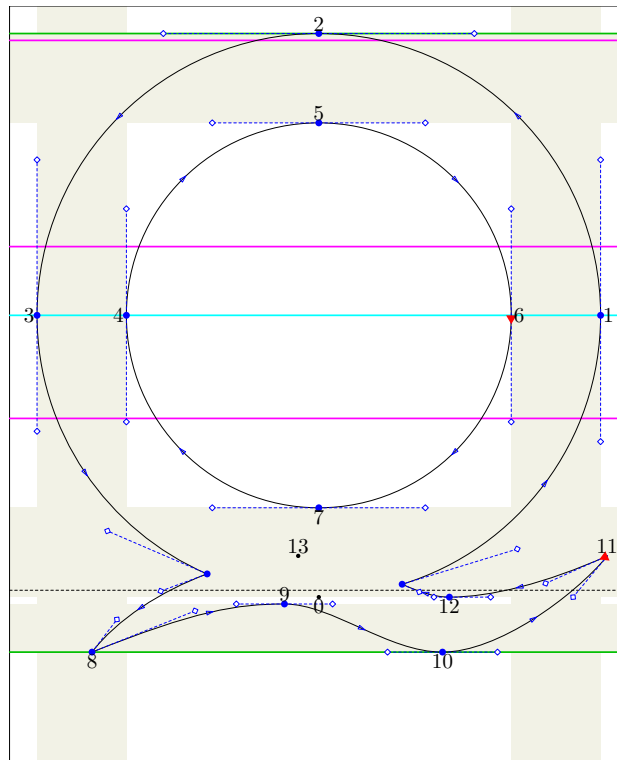

```

standard_introduce("Qwave");
beginglyph(Qwave);
y0 = -o; x3 = leftstemloc - o; y2 = uc_height + o; x1 - x3 = y2 - y0;
y7 - y0 = x1 - x6 = y2 - y5 = x4 - x3 = o + .48(py + px); y3 = y4 = y6 = y1 = .5[y2, y0];
x2 = x5 = x7 = x0 = .5[x1, x3];
x8 = leftstemloc + xu + 2u; x9 - x8 = 5xu + 3u; x13 = x9 + 2u; x10 - x13 = 4xu + u; x12 = x10 + u;
x11 - x12 = 4xu + 3u;
y12 = -u; y9 = -2u; y13 - y9 = xu + 2u; y12 - y10 = xu + 3u; y8 = y10; y11 = y13;

find_outlines(z0 .. z1 .. z2 .. z3 .. cycle, z8 .. controls(x8 + 3xu, y8 + xu + u)
  and (x9 - xu - 2u, y9) .. z9 .. controls(x9 + xu + 2u, y9) and (x10 - xu - 3u, y10)
  .. z10 .. controls(x10 + xu + 3u, y10) and (x11 - xu, y11 - xu - u)
  .. z11 .. controls(x11 - 2xu + u, y11 - xu + u) and (x12 + xu + u, y12)
  .. z12 .. controls(x12 - xu - u, y12) and (x13 + 2xu, y13)
  .. z13 .. controls(x13 - 2xu, y13) and (x8 + xu + u, y8 + xu + 3u) .. cycle)(glyph);

Fill glyph1;
unFill z4 .. z5 .. z6 .. z7 .. cycle;
fix_vstem(o + .48(py + px))(glyph_stored.glyph_name 1, glyph_stored.glyph_name 2);
fix_hstem(o + .48(py + px))(glyph_stored.glyph_name 1, glyph_stored.glyph_name 2);
fix_hstem(y13 - y9)(glyph_stored.glyph_name 1, glyph_stored.glyph_name 2);
fix_dims(x1 + rightbear - o, y2, y8, 0);

dot_labels bot(0);
just_labels bot(7, 8, 10, 12);
just_labels rt(1, 6);
just_labels top(2, 5, 9, 11);
dot_labels top(13);
just_labels lft(3, 4);

standard_exact_hsbw("Qwave");
endglyph;

```

Construction of the character R:

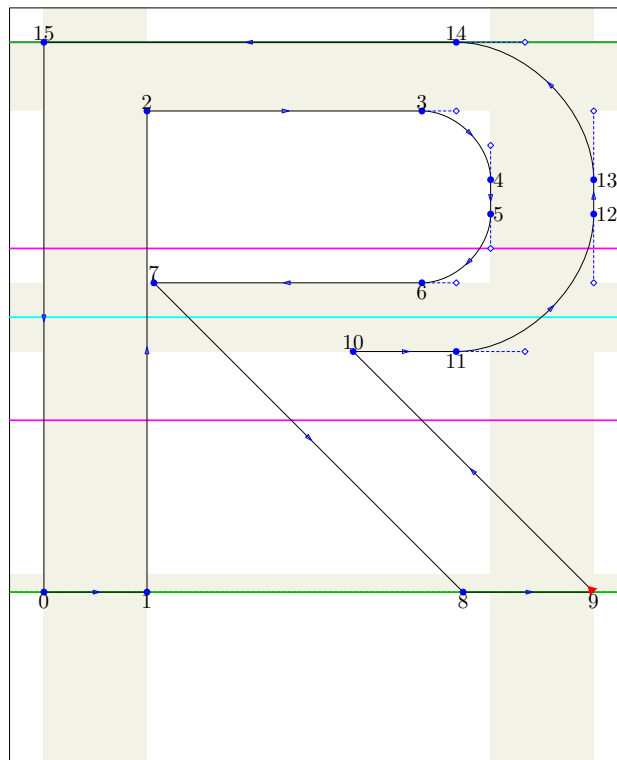

```
encode("R")(82); standard_introduce("R");
beginlyph(R);
```

```
 $y_0 = y_1 = y_8 = y_9 = 0$ ;  $x_0 = x_{15} = \text{leftstemloc}$ ;  $y_{14} = y_{15} = \text{uc\_height}$ ;  

 $x_1 - x_0 = x_2 - x_{15} = x_{12} - x_5 = x_{13} - x_4 = px$ ;  $x_3 - x_2 = 8xu$ ;  $x_4 = x_5$ ;  $x_7 - x_2 = u$ ;  

 $y_{15} - y_2 = y_{14} - y_3 = y_6 - y_{11} = y_7 - y_{10} = py$ ;  $.5[y_{10}, y_7] = .5[y_{11}, y_6] = .5\text{uc\_height}$ ;  

 $x_8 - x_7 = y_7 - y_8$ ;  $x_9 - x_{10} = y_{10} - y_9$ ;  $x_9 - x_8 = 2py - u$ ;  

 $z_{12} = z_{11} + (\text{obow}, \text{obow})$ ;  $z_{14} = z_{13} + (-\text{obow}, \text{obow})$ ;  $z_4 = z_3 + (\text{ibow}, -\text{ibow})$ ;  

 $z_6 = z_5 - (\text{ibow}, \text{ibow})$ ;
```

```
Fill  $z_0$  --  $z_1$  --  $z_2$  -- bow right(3, 4) -- bow down(5, 6)  

--  $z_7$  --  $z_8$  --  $z_9$  --  $z_{10}$  -- crescent right(11, 12) -- crescent up(13, 14) --  $z_{15}$  -- cycle;
```

```
fix_vstem(px)(glyph_stored.glyph_name 1);  

fix_hstem(py)(glyph_stored.glyph_name 1);  

fix_dimens( $x_9 + \text{rightbear}$ ,  $y_{14}$ , 0, 0);  

ghost_stem bot;
```

```
just_labels bot(0, 1, 6, 8, 9, 11);  

just_labels rt(4, 5, 12, 13);  

just_labels top(2, 3, 7, 10, 14, 15);
```

```
standard_exact_hsbw("R");  

endglyph;
```

Construction of the character S:

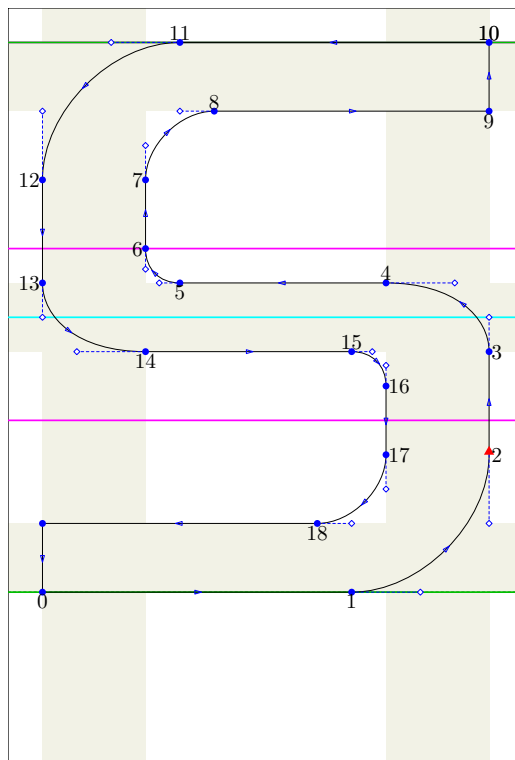

```
encode("S")(83); standard_introduce("S");
```

```
beginlyph(S);
```

```
 $y_0 = y_1 = 0$ ;  $x_0 = x_{12} = x_{13} = x_{19} = \text{leftstemloc}$ ;  $y_{10} = y_{11} = \text{uc\_height}$ ;
```

```
 $x_6 - x_{13} = x_7 - x_{12} = x_3 - x_{16} = x_2 - x_{17} = px$ ;  $x_{15} - x_5 = 5xu$ ;
```

```
 $x_9 = x_{10} = x_2 = x_3$ ;  $y_{11} - y_8 = y_{10} - y_9 = y_{18} - y_1 = y_{19} - y_0 = y_4 - y_{15} = y_5 - y_{14} = py$ ;
```

```
 $.5[y_{14}, y_5] = .5[y_{15}, y_4] = .5\text{uc\_height}$ ;
```

```
 $z_2 = z_1 + (\text{obow}, \text{obow})$ ;  $z_4 = z_3 + (-.75\text{obow}, .5\text{obow})$ ;  $z_6 = z_5 + (-.5\text{ibow}, .5\text{ibow})$ ;
```

```
 $z_8 = z_7 + (\text{ibow}, \text{ibow})$ ;  $z_{12} = z_{11} - (\text{obow}, \text{obow})$ ;  $z_{14} = z_{13} + (.75\text{obow}, -.5\text{obow})$ ;
```

```
 $z_{16} = z_{15} + (.5\text{ibow}, -.5\text{ibow})$ ;  $z_{18} = z_{17} - (\text{ibow}, \text{ibow})$ ;
```

```
Fill  $z_0$  -- crescent right(1, 2) -- bend up(3, 4)(octl, (1, .5)) -- small_bow left(5, 6)
```

```
-- bow up(7, 8) --  $z_9$  --  $z_{10}$  -- crescent left(11, 12) -- bend down(13, 14)(octl, (1, .5))
```

```
-- small_bow right(15, 16) -- bow down(17, 18) --  $z_{19}$  -- cycle;
```

```
fix_vstem(px)(glyph_stored.glyph_name 1);
```

```
fix_hstem(py)(glyph_stored.glyph_name 1);
```

```
fix_dimens( $x_2 + \text{rightbear}$ ,  $y_{10}$ , 0, 0);
```

```
just_labels bot(0, 1, 5, 9, 14, 18);
```

```
just_labels rt(2, 3, 16, 17);
```

```
just_labels top(4, 8, 10, 11, 15, 10);
```

```
just_labels lft(6, 7, 12, 13);
```

```
standard_exact_hsbw("S");
```

```
endglyph;
```

Construction of the character S.alt:

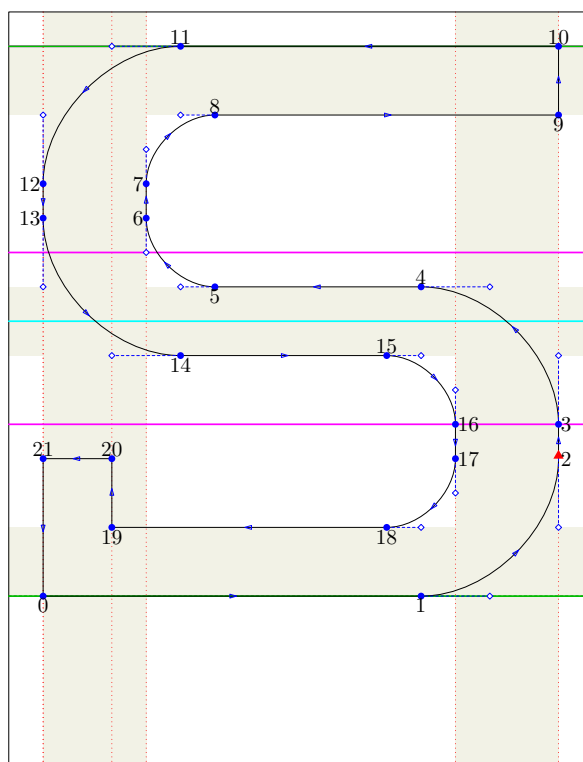

```

standard_introduce("S.alt");
beginlyph(S alt);
y0 = y1 = 0; x0 = x12 = x13 = x21 = leftstemloc; y10 = y11 = uc_height;
x20 - x21 = xgap; x19 = x20; x6 - x13 = x7 - x12 = x3 - x16 = x2 - x17 = px; x15 - x5 = 5xu;
x9 = x10 = x2 = x3; y11 - y8 = y10 - y9 = y18 - y1 = y19 - y0 = y4 - y15 = y5 - y14 = py;
y20 - y19 = 2xu; y20 = y21; .5[y14, y5] = .5[y15, y4] = .5uc_height;
z2 = z1 + (obow, obow); z4 = z3 + (-obow, obow); z6 = z5 + (-ibow, ibow);
z8 = z7 + (ibow, ibow); z12 = z11 - (obow, obow); z14 = z13 + (obow, -obow);
z16 = z15 + (ibow, -ibow); z18 = z17 - (ibow, ibow);
hh0 := y18; hh1 := y20;

Fill z0 -- crescent right(1, 2) -- crescent up(3, 4) -- bow left(5, 6)
-- bow up(7, 8) -- z9 -- z10 -- crescent left(11, 12) -- crescent down(13, 14)
-- bow right(15, 16) -- bow down(17, 18) -- z19 -- z20 -- z21 -- cycle;

fix_vstem(px)(glyph_stored.glyph_name 1);
fix_vstem(xgap)(glyph_stored.glyph_name 1);
fix_hstem(py)(glyph_stored.glyph_name 1)((y <= hh0) or (y > hh1));
fix_dimens(x2 + rightbear, y10, 0, 0);

just_labels bot(0, 1, 5, 9, 14, 18, 19);
just_labels rt(2, 3, 16, 17);
just_labels top(4, 8, 10, 11, 15, 20, 21);
just_labels lft(6, 7, 12, 13);

standard_exact_hsbw("S.alt");
endglyph;

```

Construction of the character T:

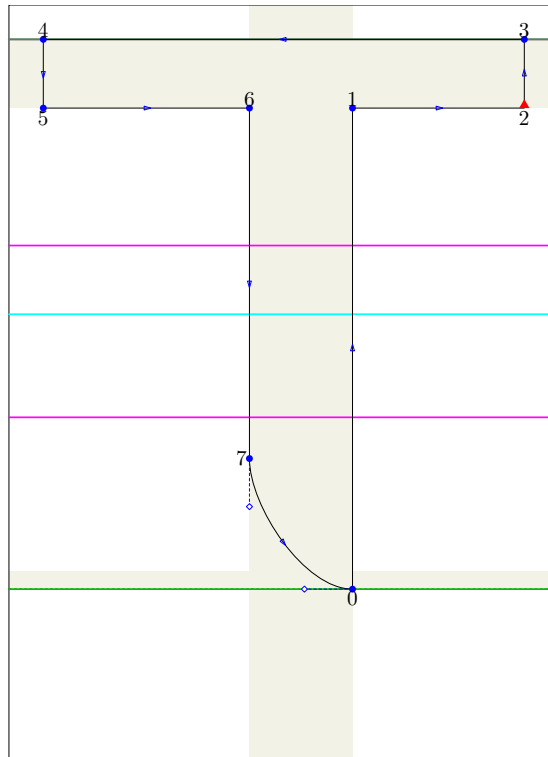

```

encode("T")(84); standard_introduce("T");
beginlyph(T);
 $y_0 = 0; x_4 = x_5 = \text{leftstemloc}; y_3 = y_4 = \text{uc\_height};$ 
 $x_6 - x_5 = 6xu; x_2 - x_1 = 5xu; x_6 = x_7; x_1 - x_6 = x_0 - x_7 = px; x_3 = x_2;$ 
 $y_3 - y_1 = y_3 - y_2 = y_4 - y_5 = y_4 - y_6 = py; y_7 = y_0 + \text{lbw};$ 

Fill  $z_0 \text{ -- } z_1 \text{ -- } z_2 \text{ -- } z_3 \text{ -- } z_4 \text{ -- } z_5 \text{ -- } z_6 \text{ -- } \text{stem\_crescent}(7, 0) \text{ \& cycle};$ 
fix_vstem( $px$ )( $\text{glyph\_stored.glyph\_name } 1$ );
fix_hstem( $py$ )( $\text{glyph\_stored.glyph\_name } 1$ );
fix_dimens( $x_2 + \text{rightbear}, y_3, 0, 0$ );
ghost_stem bot;

just_labels bot(0, 2, 5);
just_labels top(1, 3, 4, 6);
just_labels lft(7);

standard_exact_hsbw("T");
endglyph;

```

Construction of the character U:

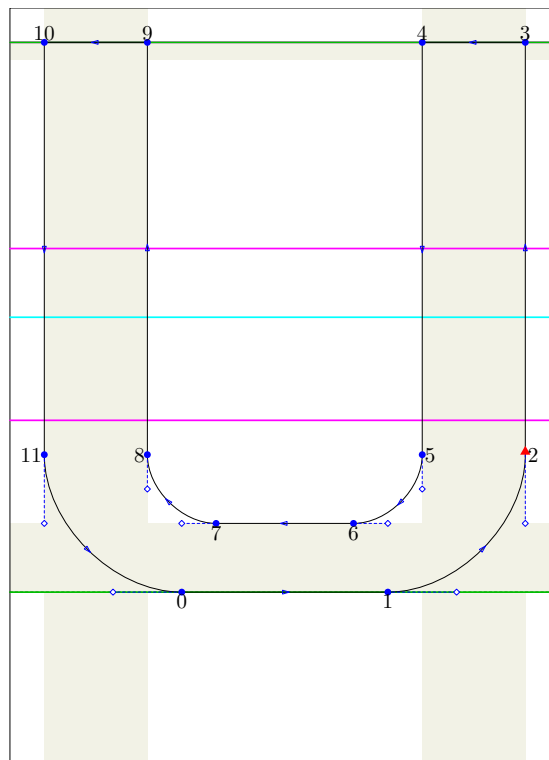

```

encode("U")(85); standard_introduce("U");
beginlyph(U);
 $y_0 = y_1 = 0; x_{10} = x_{11} = \text{leftstemloc}; y_3 = y_4 = y_9 = y_{10} = \text{uc\_height};$ 
 $x_9 - x_{10} = x_8 - x_{11} = x_2 - x_5 = x_3 - x_4 = px; x_4 = x_5; x_6 - x_7 = 4xu;$ 
 $y_7 - y_0 = y_6 - y_1 = py;$ 
 $z_2 = z_1 + (\text{obow}, \text{obow}); z_6 = z_5 - (\text{ibow}, \text{ibow}); z_8 = z_7 + (-\text{ibow}, \text{ibow});$ 
 $z_0 = z_{11} + (\text{obow}, -\text{obow});$ 
Fill  $z_0$  -- crescent right(1, 2) --  $z_3$  --  $z_4$  -- bow down(5, 6) -- bow left(7, 8)
  --  $z_9$  --  $z_{10}$  -- crescent down(11, 0) & cycle;
fix_vstem( $px$ )(glyph_stored.glyph_name 1);
fix_hstem( $py$ )(glyph_stored.glyph_name 1);
ghost_stem top;
fix_dimens( $x_2 + \text{rightbear}$ ,  $y_3$ , 0, 0);
just_labels bot(0, 1, 6, 7);
just_labels top(3, 4, 9, 10);
just_labels lft(8, 11);
just_labels rt(2, 5);
standard_exact_hsbw("U");
endglyph;

```

Construction of the character V:

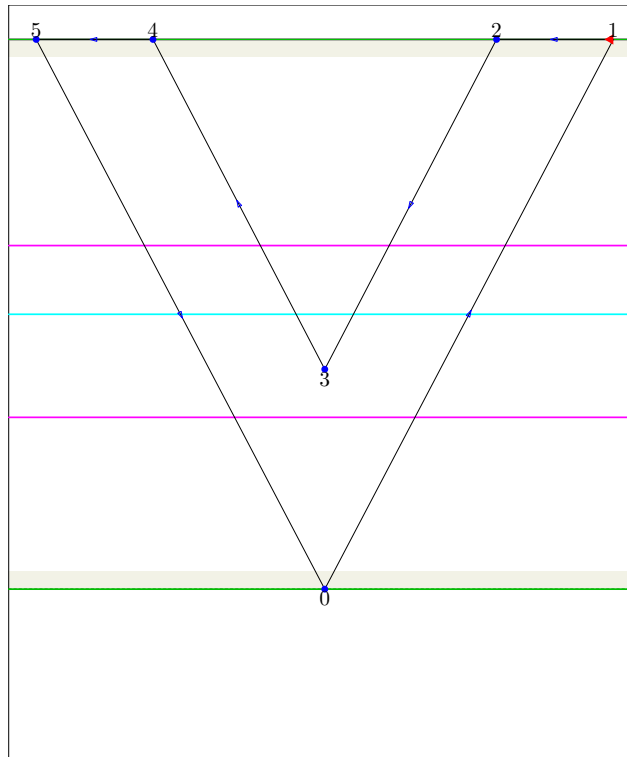

```

encode("V")(86); standard_introduce("V");
beginlyph(V);
 $y_0 = 0; x_5 = \text{leftstemloc} - o; y_1 = y_2 = y_4 = y_5 = \text{uc\_height};$ 
 $x_1 - x_2 = x_4 - x_5 = px + u + o; x_2 - x_3 = x_3 - x_4 = 5xu; x_0 = x_3; y_3 - y_0 = 2px + 2u;$ 
Fill  $z_0$  --  $z_1$  --  $z_2$  --  $z_3$  --  $z_4$  --  $z_5$  -- cycle;
fix_dimens( $x_1 + \text{rightbear} - o, y_1, 0, 0$ );
ghost_stem top, bot;
just_labels bot(0, 3);
just_labels top(1, 2, 4, 5);
standard_exact_hsbw("V");
endglyph;

```

Construction of the character W:

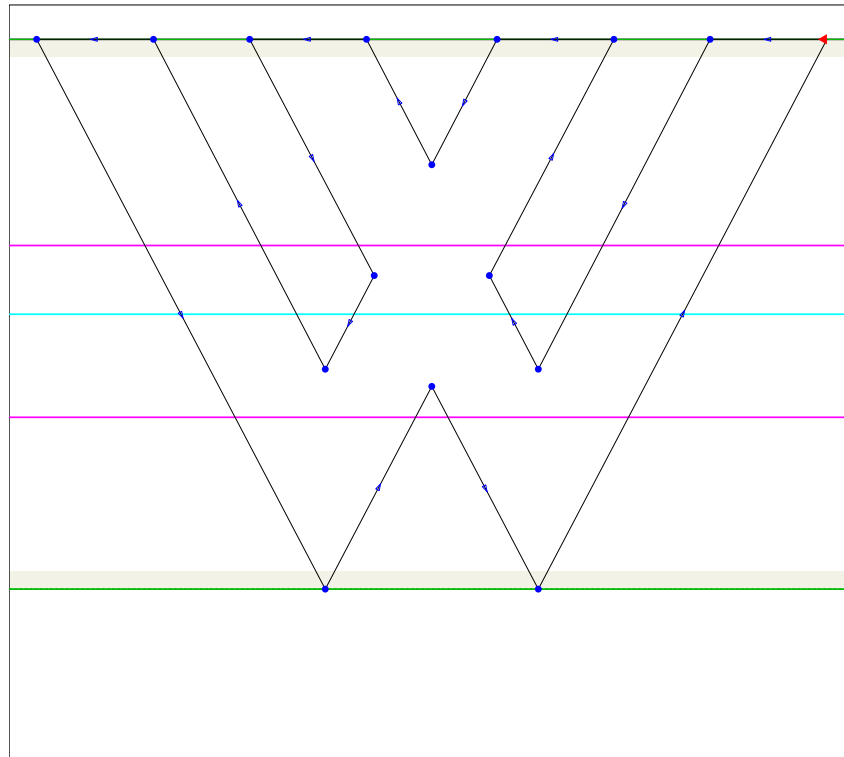

```

encode("W")(87); standard_introduce("W");
beginglyph(W);
find_outlines(glyph_stored.V 1, glyph_stored.V 1 shifted ( $2px + 2u - o$ ), 0)(glyph);
Fill glyph1;

use_stems(V);
fix_dimens( $wd.V + 2px + 2u - o$ , ht.V, 0, 0);

standard_exact_hsbw("W");
endglyph;

```

Construction of the character X:

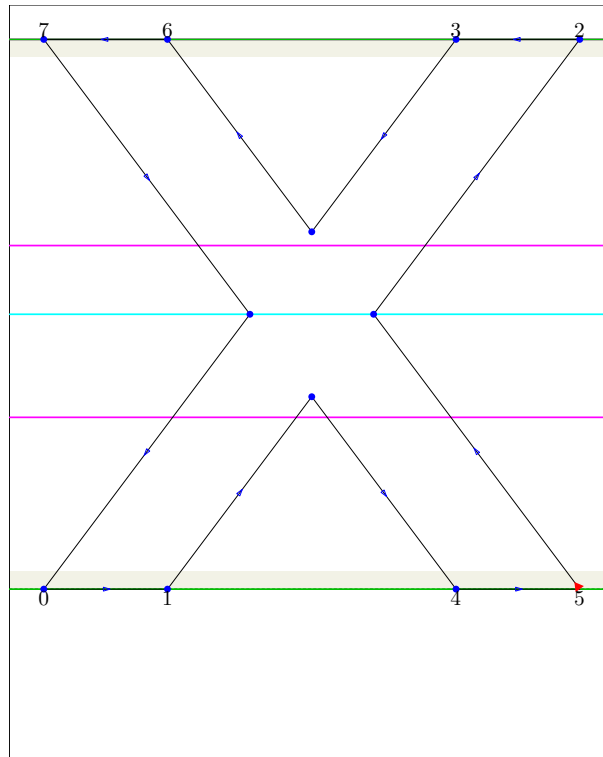

```

encode("X")(88); standard_introduce("X");
beginglyph(X);
 $y_0 = y_1 = y_4 = y_5 = 0$ ;  $x_0 = x_7 = \text{leftstemloc}$ ;  $y_2 = y_3 = y_6 = y_7 = \text{uc\_height}$ ;
 $x_4 - x_1 = x_3 - x_6 = 8xu + 2u$ ;  $x_1 - x_0 = x_5 - x_4 = x_2 - x_3 = x_6 - x_7 = px + 3u$ ;

find_outlines( $z_0 -- z_1 -- z_2 -- z_3 -- \text{cycle}$ ,  $z_4 -- z_5 -- z_6 -- z_7 -- \text{cycle}$ )(glyph);
Fill glyph1;

ghost_stem top, bot;
fix_dimens( $x_5 + \text{rightbear}$ ,  $y_2$ , 0, 0);

just_labels bot(0, 1, 4, 5);
just_labels top(2, 3, 6, 7);

standard_exact_hsbw("X");
endglyph;

```

Construction of the character Y:

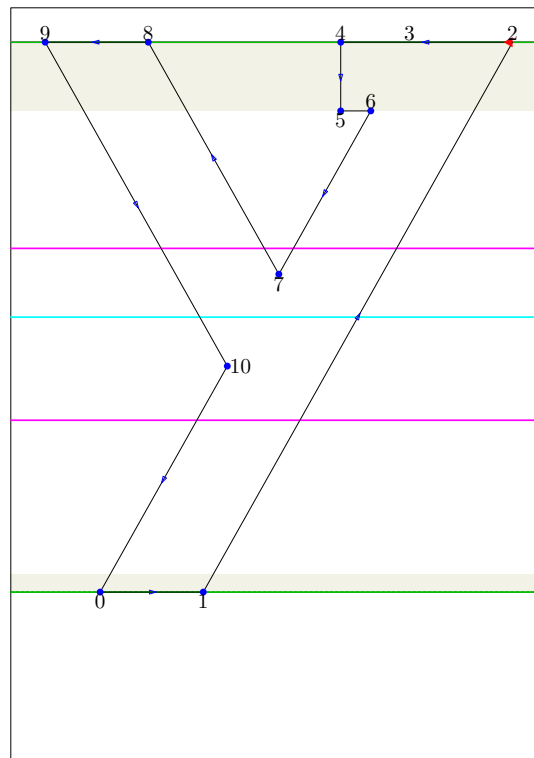

```

encode("Y")(89); standard_introduce("Y");
beginlyph(Y);
 $y_0 = y_1 = y_{11} = y_{12} = 0$ ;  $x_9 = \textit{leftstemloc}$ ;  $y_2 = y_3 = y_4 = y_8 = y_9 = \textit{uc\_height}$ ;
 $x_1 - x_0 = x_2 - x_3 = x_8 - x_9 = x_{12} - x_{11} = \textit{px}$ ;  $x_{11} - x_8 = 6xu$ ;  $x_3 - x_1 = 6xu$ ;
 $x_{11} - x_1 = 4xu + 2u$ ;  $x_5 = x_4$ ;  $x_3 - x_4 = \textit{xgap}$ ;  $y_4 - y_5 = y_3 - y_6 = \textit{py}$ ;
 $z_{10} = \textit{whatever}[z_0, z_3] = \textit{whatever}[z_{11}, z_9]$ ;  $z_7 = \textit{whatever}[z_0, z_3] = \textit{whatever}[z_{12}, z_8]$ ;
 $z_6 = \textit{whatever}[z_0, z_3]$ ;

Fill  $z_0$  --  $z_1$  --  $z_2$  --  $z_4$  --  $z_5$  --  $z_6$  --  $z_7$  --  $z_8$  --  $z_9$  --  $z_{10}$  -- cycle;

fix_hstem( $\textit{py}$ )( $\textit{glyph\_stored.glyph\_name}$  1);
ghost_stem  $\textit{bot}$ ;
fix_dimens( $x_2 + \textit{rightbear}$ ,  $y_2$ , 0, 0);

just_labels  $\textit{bot}$ (0, 1, 5, 7);
just_labels  $\textit{top}$ (2, 3, 4, 6, 8, 9);
just_labels  $\textit{rt}$ (10);

standard_exact_hsbw("Y");
endglyph;

```

Construction of the character Z:

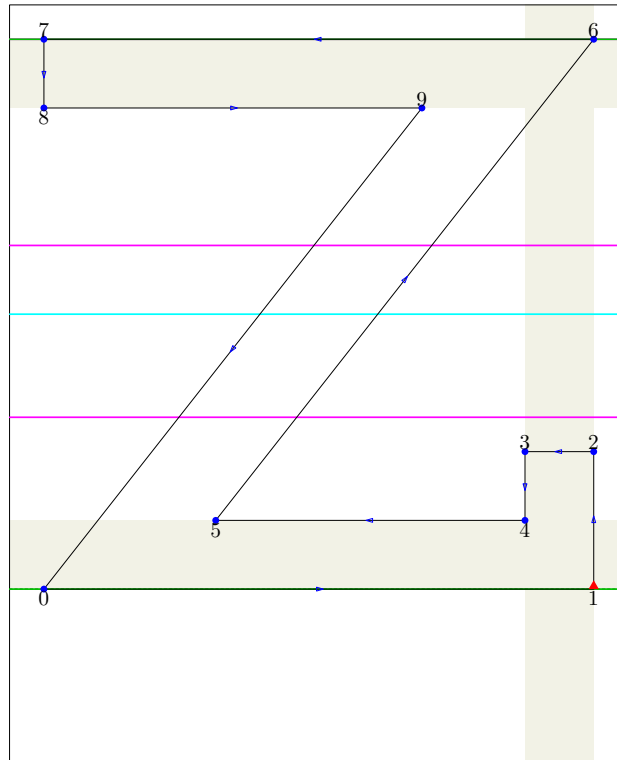

```

encode("Z")(90); standard_introduce("Z");
beginglyph(Z);
 $y_0 = y_1 = 0$ ;  $x_0 = x_7 = x_8 = \text{leftstemloc}$ ;  $y_6 = y_7 = \text{uc\_height}$ ;
 $x_5 - x_0 = x_6 - x_9 = px + 2xu$ ;  $x_9 - x_8 = 11xu$ ;  $x_6 = x_2$ ;  $x_2 - x_3 = x_1 - x_4 = \text{xgap}$ ;  $x_3 = x_4$ ;
 $y_7 - y_8 = y_6 - y_9 = y_4 - y_1 = y_5 - y_0 = py$ ;  $y_3 - y_4 = 2xu$ ;  $y_2 = y_3$ ;
 $hh_0 := y_4$ ;  $hh_1 := y_2$ ;

Fill  $z_0$  --  $z_1$  --  $z_2$  --  $z_3$  --  $z_4$  --  $z_5$  --  $z_6$  --  $z_7$  --  $z_8$  --  $z_9$  -- cycle;

fix_vstem( $x_{gap}$ )(glyph_stored.glyph_name 1);
fix_hstem( $py$ )(glyph_stored.glyph_name 1)(( $y \leq hh_0$ ) or ( $y > hh_1$ ));
fix_dimens( $x_1 + \text{rightbear}$ ,  $y_6$ , 0, 0);

just_labels bot(0, 1, 4, 5, 8);
just_labels top(2, 3, 6, 7, 9);

standard_exact_hsbw("Z");
endglyph;

```

Construction of the character Zcaron:

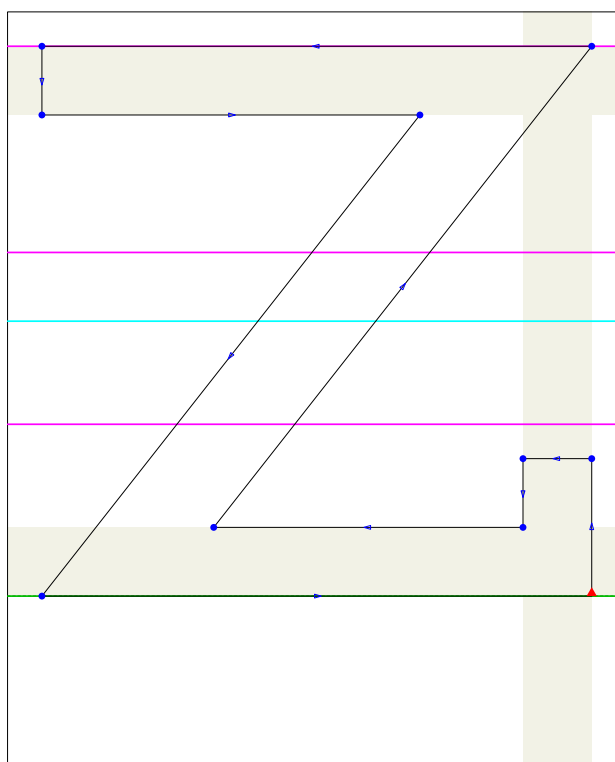

```

encode("Zcaron")(30); standard_introduce("Zcaron");
begin_glyph(Zcaron);
use_accent(Z, caron);

fix_dimens(wd.Z, ht.Z + ht.caron - lc_height, 0, 0);

standard_exact_hsbw("Zcaron");
end_glyph;

```

Construction of the character `bracketleft`:

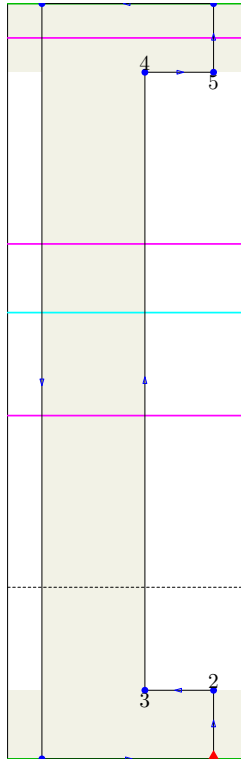

```

encode("bracketleft")(91); standard_introduce("bracketleft");
begin_glyph(bracketleft);
 $y_0 = y_1 = \text{descender}; x_0 = x_7 = \text{leftstemloc}; y_6 = y_7 = \text{ascender};$ 
 $x_4 - x_7 = x_3 - x_0 = px; x_5 - x_4 = x_2 - x_3 = 2xu; x_6 = x_5; x_1 = x_2;$ 
 $y_6 - y_5 = y_7 - y_4 = y_2 - y_1 = y_3 - y_0 = py;$ 
Fill  $z_0 \text{ -- } z_1 \text{ -- } z_2 \text{ -- } z_3 \text{ -- } z_4 \text{ -- } z_5 \text{ -- } z_6 \text{ -- } z_7 \text{ -- cycle};$ 
fix_vstem( $px$ )(glyph_stored.glyph_name 1);
fix_hstem( $py$ )(glyph_stored.glyph_name 1);
fix_dimens( $x_1 + \text{rightbear}, y_6, y_0, 0$ );
just_labels bot(0, 1, 3, 5);
just_labels top(2, 4, 6, 7);
standard_exact_hsbw("bracketleft");
end_glyph;

```

Construction of the character backslash:

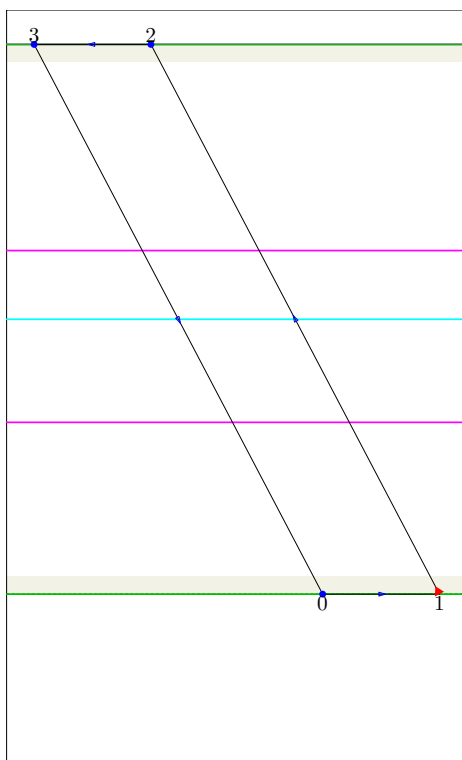

```
encode("backslash")(92); standard_introduce("backslash");
```

```
begin_glyph(backslash);
```

```
 $y_0 = y_1 = 0; x_3 = \text{leftstemloc} - o; y_2 = y_3 = \text{uc.height};$ 
```

```
 $x_1 - x_0 = x_2 - x_3 = px + u + o; x_0 - x_2 = 5xu;$ 
```

```
Fill  $z_0$  --  $z_1$  --  $z_2$  --  $z_3$  -- cycle;
```

```
ghost_stem top, bot;
```

```
fix_dimens( $x_1 + \text{rightbear} - o, y_2, 0, 0$ );
```

```
just_labels bot(0, 1);
```

```
just_labels top(2, 3);
```

```
standard_exact_hsbw("backslash");
```

```
end_glyph;
```

Construction of the character `bracketright`:

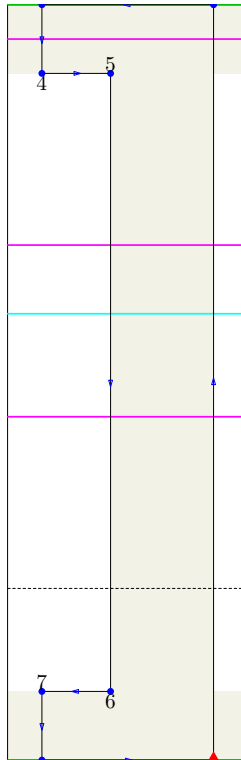

```

encode("bracketright")(93); standard_introduce("bracketright");
beginlyph(bracketright);
 $y_0 = y_1 = \text{descender}; x_0 = x_3 = x_4 = x_7 = \text{leftstemloc}; y_2 = y_3 = \text{ascender};$ 
 $x_1 - x_6 = x_2 - x_5 = px; x_5 - x_4 = x_6 - x_7 = 2xu;$ 
 $y_7 - y_0 = y_6 - y_1 = y_2 - y_5 = y_3 - y_4 = py;$ 
Fill  $z_0 -- z_1 -- z_2 -- z_3 -- z_4 -- z_5 -- z_6 -- z_7 -- \text{cycle};$ 
fix_vstem( $px$ )(glyph_stored.glyph_name 1);
fix_hstem( $py$ )(glyph_stored.glyph_name 1);
fix_dimens( $x_1 + \text{rightbear}, y_2, y_0, 0$ );
just_labels bot(0, 1, 4, 6);
just_labels top(2, 3, 5, 7);
standard_exact_hsbw("bracketright");
endglyph;

```

Construction of the character `asciicircum`:

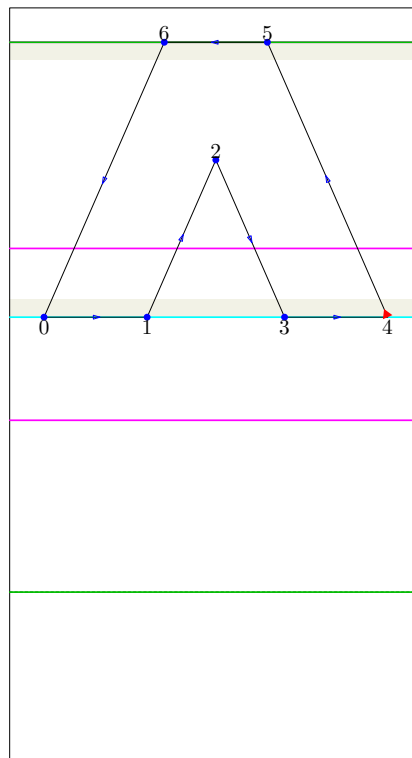

```

encode("asciicircum")(94); standard_introduce("asciicircum");
begin_glyph(asciicircum);
x_0 = leftstemloc; y_5 = y_6 = uc_height;
y_0 = y_1 = y_3 = y_4 = .5uc_height;
x_1 - x_0 = x_4 - x_3 = x_5 - x_6 = px; x_3 - x_1 = 4xu; .5[x_6, x_5] = .5[x_1, x_3];
z_2 = whatever[z_1, z_5] = whatever[z_3, z_6];

Fill z_0 -- z_1 -- z_2 -- z_3 -- z_4 -- z_5 -- z_6 -- cycle;

ghost_stem top, bot;
fix_dimens(x_4 + rightbear, y_5, 0, 0);

just_labels bot(0, 1, 3, 4);
just_labels top(2, 5, 6);

standard_exact_hsbw("asciicircum");
end_glyph;

```

Construction of the character underscore:

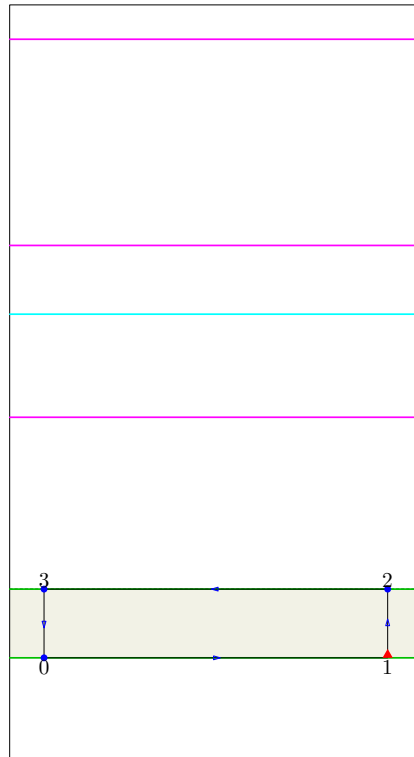

```

encode("underscore")(95); standard_introduce("underscore");
beginglyph(underscore);
 $y_2 = y_3 = 0$ ;  $x_0 = x_3 = \textit{leftstemloc}$ ;
 $y_3 - y_0 = y_2 - y_1 = py$ ;  $x_2 - x_3 = x_1 - x_0 = 10xu$ ;
Fill  $z_0$  --  $z_1$  --  $z_2$  --  $z_3$  -- cycle;
fix_hstem(py)(glyph_stored.glyph_name 1);
fix_dimens( $x_1 + \textit{rightbear}$ ,  $y_2$ ,  $y_0$ , 0);
just_labels bot(0, 1);
just_labels top(2, 3);
standard_exact_hsbw("underscore");
endglyph;

```

Construction of the character grave:

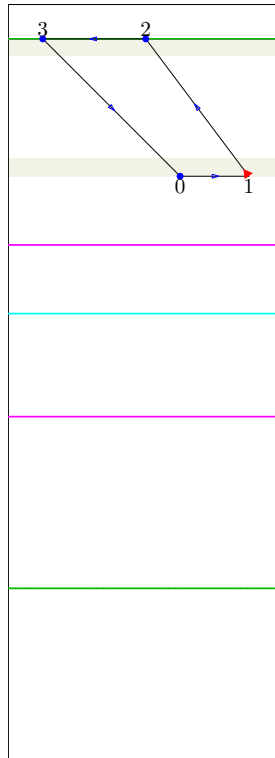

```

encode("grave")(96); standard_introduce("grave");
begin_glyph(grave);
 $x_3 = \text{leftstemloc}$ ;
 $x_2 - x_3 = px = x_1 - x_0 + xu$ ;  $y_3 - y_0 = y_2 - y_1 = 4xu$ ;
 $x_1 - x_2 = 3xu$ ;
 $y_0 = y_1 = \text{lc\_height} + 2xu$ ;
Fill  $z_0$  --  $z_1$  --  $z_2$  --  $z_3$  -- cycle;
ghost_stem top, bot;
fix_dimens( $x_1 + \text{rightbear}$ ,  $y_2$ , 0, 0);
just_labels bot(0, 1);
just_labels top(2, 3);
standard_exact_hsbw("grave");
end_glyph;

```

Construction of the character a:

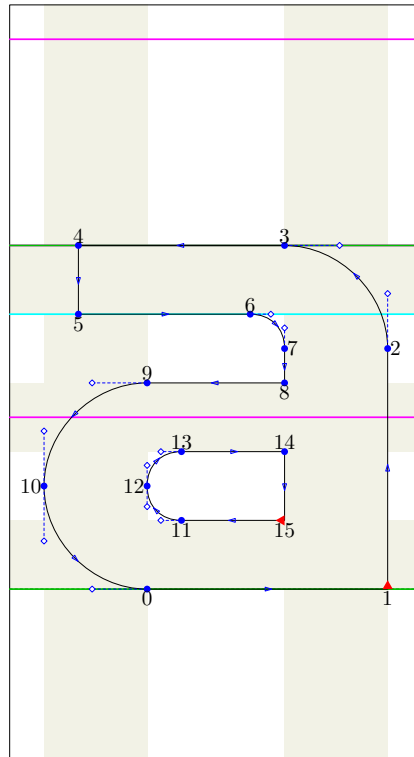

```

encode("a")(97); standard_introduce("a");
beginlyph(a);
 $y_0 = y_1 = 0; x_{10} = \text{leftstemloc}; y_3 = y_4 = \text{lc\_height};$ 
 $x_{12} - x_{10} = x_2 - x_7 = x_1 - x_{15} = px; x_8 = x_7; x_2 = x_1;$ 
 $x_4 = x_5 = x_{10} + xu; x_{14} - x_{13} = x_{15} - x_{11} = 3xu;$ 
 $y_{11} - y_0 = y_{15} - y_1 = y_8 - y_{14}$ 
 $= y_9 - y_{13} = y_3 - y_6 = y_4 - y_5 = py; y_{14} = y_{13};$ 
 $z_3 = z_2 + (-.75obow, .75obow); z_7 = z_6 + (.5ibow, -.5ibow);$ 
 $z_{10} = z_9 - (.75obow, .75obow); z_0 = z_{10} + (.75obow, -.75obow);$ 
 $z_{12} = z_{11} + (-.5ibow, .5ibow); z_{13} = z_{12} + (.5ibow, .5ibow);$ 
 $hh_0 := y_{11}; hh_1 := y_{14}; hh_2 := y_8; hh_3 := y_6;$ 

Fill  $z_0$  --  $z_1$  -- small_crescent up(2, 3) --  $z_4$  --  $z_5$  -- small_bow right(6, 7)
  --  $z_8$  -- small_crescent left(9, 10) & small_crescent down(10, 0) & cycle;
unFill small_bow left(11, 12) & small_bow up(12, 13) --  $z_{14}$  --  $z_{15}$  -- cycle;

fix_vstem( $px$ )(glyph_stored.glyph_name 1, glyph_stored.glyph_name 2);
fix_hstem( $py$ )(glyph_stored.glyph_name 1,
  glyph_stored.glyph_name 2)(( $y \leq hh_0$ ) or ( $y \geq hh_3$ ));
fix_hstem( $py$ )(glyph_stored.glyph_name 1,
  glyph_stored.glyph_name 2)(( $y \geq hh_1$ ) and ( $y \leq hh_2$ ));
fix_dims( $x_1 + \text{rightbear}$ ,  $y_4$ , 0, 0);

just_labels bot(0, 1, 5, 8, 11, 15);
just_labels top(3, 4, 6, 9, 13, 14);
just_labels rt(2, 7);
just_labels lft(10, 12);

standard_exact_hsbw("a");
endglyph;

```

Construction of the character b:

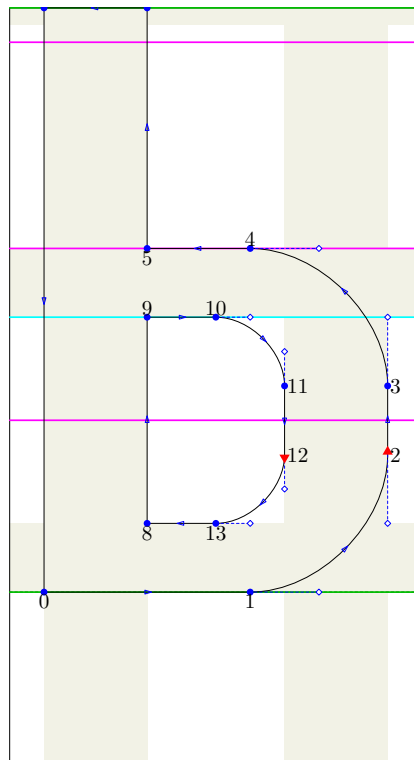

```

encode("b")(98); standard_introduce("b");
beginlyph(b);
 $y_0 = y_1 = 0; x_0 = x_7 = \text{leftstemloc}; y_6 = y_7 = \text{ascender};$ 
 $x_8 - x_0 = x_6 - x_7 = x_3 - x_{11} = x_2 - x_{12} = px; x_5 = x_6; x_9 = x_8;$ 
 $x_{10} - x_9 = x_{13} - x_8 = 2xu;$ 
 $y_5 = y_4 = \text{lc.height};$ 
 $y_5 - y_9 = y_4 - y_{10} = y_8 - y_0 = y_{13} - y_1 = py;$ 

 $z_2 = z_1 + (\text{obow}, \text{obow}); z_4 = z_3 + (-\text{obow}, \text{obow}); z_{11} = z_{10} + (\text{ibow}, -\text{ibow});$ 
 $z_{13} = z_{12} - (\text{ibow}, \text{ibow});$ 

Fill  $z_0$  -- crest right(1, 2) -- crest up(3, 4) --  $z_5$  --  $z_6$  --  $z_7$  -- cycle;
unFill  $z_8$  --  $z_9$  -- bow right(10, 11) -- bow down(12, 13) -- cycle;

fix_hstem( $py$ )(glyph_stored.glyph_name 1, glyph_stored.glyph_name 2);
fix_vstem( $px$ )(glyph_stored.glyph_name 1, glyph_stored.glyph_name 2);
fix_dimens( $x_2 + \text{rightbear}, y_7, 0, 0$ );
ghost_stem top;

just_labels bot(0, 1, 5, 8, 13);
just_labels top(4, 6, 7, 9, 10);
just_labels rt(2, 3, 11, 12);

standard_exact_hsbw("b");
endglyph;

```

Construction of the character c:

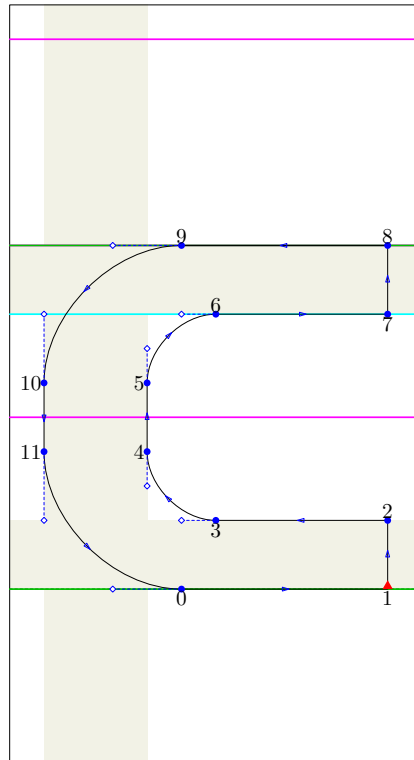

```

encode("c")(99); standard_introduce("c");
beginlyph(c);
 $y_0 = y_1 = 0; x_{11} = x_{10} = \text{leftstemloc}; y_8 = y_9 = \text{lc.height};$ 
 $x_7 - x_6 = x_2 - x_3 = 5xu; x_2 = x_1; x_8 = x_7;$ 
 $x_4 - x_{11} = x_5 - x_{10} = px; y_2 - y_1 = y_3 - y_0 = y_8 - y_7 = y_9 - y_6 = py;$ 
 $z_0 = z_{11} + (\text{obow}, -\text{obow}); z_{10} = z_9 + (-\text{obow}, -\text{obow});$ 
 $z_4 = z_3 + (-\text{ibow}, \text{ibow}); z_6 = z_5 + (\text{ibow}, \text{ibow});$ 

Fill  $z_0$  --  $z_1$  --  $z_2$  -- bow left(3, 4) -- bow up(5, 6) --  $z_7$  --  $z_8$ 
  -- crescent left(9, 10) -- crescent down(11, 0) & cycle;

fix_vstem( $px$ )(glyph_stored.glyph_name 1);
fix_hstem( $py$ )(glyph_stored.glyph_name 1);
fix_dimens( $x_1 + \text{rightbear}, y_8, 0, 0$ );

just_labels bot(0, 1, 3, 7);
just_labels top(2, 6, 8, 9);
just_labels lft(4, 5, 10, 11);

standard_exact_hsbw("c");
endglyph;

```

Construction of the character d:

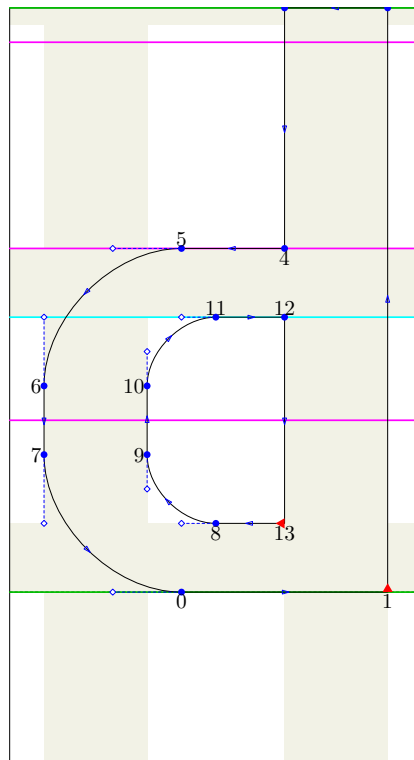

```

encode("d")(100); standard_introduce("d");
beginlyph(d);
 $y_0 = y_1 = 0$ ;  $x_6 = x_7 = \text{leftstemloc}$ ;  $y_3 = y_2 = \text{ascender}$ ;
 $x_{10} - x_6 = x_9 - x_7 = x_2 - x_3 = x_1 - x_{13} = px$ ;  $x_{12} - x_{11} = x_{13} - x_8 = 2xu$ ;  $x_3 = x_4 = x_{12}$ ;
 $y_4 = y_5 = \text{lc.height}$ ;  $y_8 - y_0 = y_{13} - y_1 = y_4 - y_{12} = y_5 - y_{11} = py$ ;

 $z_6 = z_5 - (\text{obow}, \text{obow})$ ;  $z_0 = z_7 + (\text{obow}, -\text{obow})$ ;
 $z_9 = z_8 + (-\text{ibow}, \text{ibow})$ ;  $z_{11} = z_{10} + (\text{ibow}, \text{ibow})$ ;

Fill  $z_0$  --  $z_1$  --  $z_2$  --  $z_3$  --  $z_4$  -- crescent left(5, 6) -- crescent down(7, 0) & cycle;
unFill bow left(8, 9) -- bow up(10, 11) --  $z_{12}$  --  $z_{13}$  -- cycle;

fix_vstem( $px$ )(glyph_stored.glyph_name 1, glyph_stored.glyph_name 2);
fix_hstem( $py$ )(glyph_stored.glyph_name 1, glyph_stored.glyph_name 2);
fix_dimens( $x_1 + \text{rightbear}$ ,  $y_2$ , 0, 0);
ghost_stem top;

just_labels bot(0, 1, 4, 8, 13);
just_labels top(2, 3, 5, 11, 12);
just_labels lft(6, 7, 9, 10);

standard_exact_hsbw("d");
endglyph;

```

Construction of the character e:

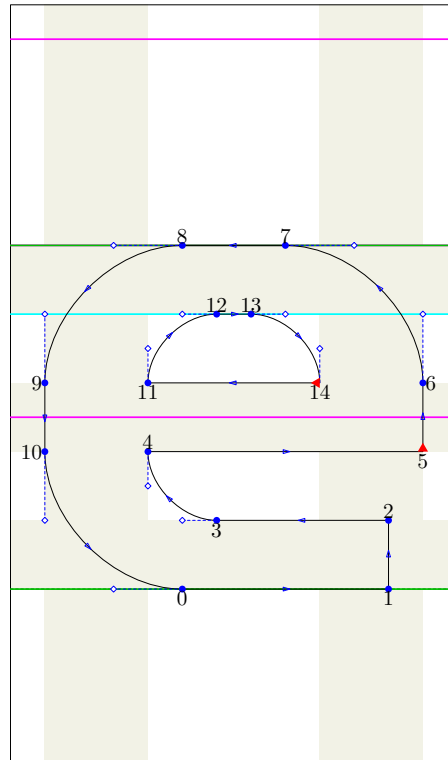

```

encode("e")(101); standard_introduce("e");
beginlyph(e);
 $y_0 = y_1 = 0; x_9 = x_{10} = \text{leftstemloc}; y_8 = y_7 = \text{lc\_height};$ 
 $x_4 - x_{10} = x_{11} - x_9 = x_6 - x_{14} = px; x_5 = x_6; x_2 = x_1; x_5 - x_2 = xu; x_{13} = x_{12} + xu;$ 
 $y_8 - y_{12} = y_7 - y_{13} = y_3 - y_0 = y_2 - y_1 = py; y_5 = y_4;$ 
 $hh_0 := y_2; hh_1 := y_4; hh_2 := y_{11}; hh_3 := y_{12};$ 

 $z_4 = z_3 + (-ibow, ibow); z_7 = z_6 + (-obow, obow); z_9 = z_8 - (obow, obow);$ 
 $z_0 = z_{10} + (obow, -obow); z_{12} = z_{11} + (ibow, ibow); z_{14} = z_{13} + (ibow, -ibow);$ 

Fill  $z_0$  --  $z_1$  --  $z_2$  -- bow left(3, 4) --  $z_5$  -- crest up(6, 7) -- crest left(8, 9)
  -- crest down(10, 0) & cycle;
unFill bow up(11, 12) -- bow right(13, 14) -- cycle;

fix_vstem(px)(glyph_stored.glyph_name 1, glyph_stored.glyph_name 2);
fix_hstem(py)(glyph_stored.glyph_name 1,
  glyph_stored.glyph_name 2)((y <= hh0) or (y >= hh3));
fix_hstem(py)(glyph_stored.glyph_name 1,
  glyph_stored.glyph_name 2)((y >= hh1) and (y <= hh2));
fix_dimens(x5 + rightbear, y7, 0, 0);

just_labels bot(0, 1, 3, 5, 11, 14);
just_labels top(2, 4, 7, 8, 12, 13);
just_labels rt(6);
just_labels lft(9, 10);

standard_exact_hsbw("e");
endglyph;

```

Construction of the character f:

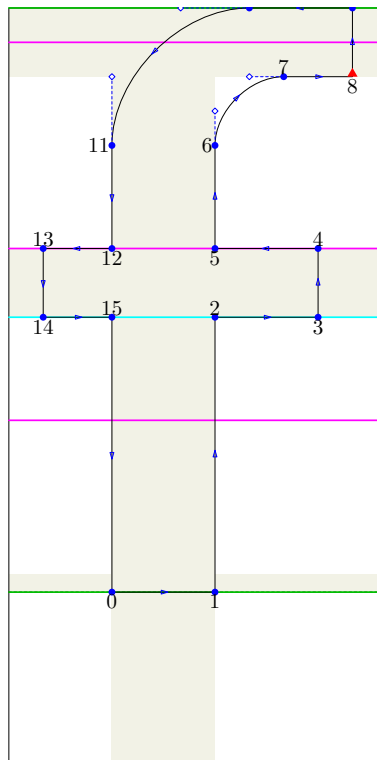

```

encode("f")(102); standard_introduce("f");
beginlyph(f);
 $y_0 = y_1 = 0; x_{13} = x_{14} = \text{leftstemloc}; y_9 = y_{10} = \text{ascender};$ 
 $x_1 - x_0 = x_2 - x_{15} = x_5 - x_{12} = x_6 - x_{11} = px; x_{11} = x_{12}; x_0 = x_{15}; x_9 = x_8;$ 
 $x_4 - x_5 = x_3 - x_2 = 3xu; x_{12} - x_{13} = x_{15} - x_{13} = 2xu; x_8 - x_7 = 2xu;$ 
 $y_4 = y_5 = y_{12} = y_{13} = \text{lc\_height};$ 
 $y_9 - y_8 = y_{10} - y_7 = y_4 - y_3 = y_5 - y_2$ 
 $= y_{12} - y_{15} = y_{13} - y_{14} = py;$ 
 $z_7 = z_6 + (\text{ibow}, \text{ibow}); z_{11} = z_{10} - (\text{obow}, \text{obow});$ 
 $hv_0 := x_{14}; hv_1 := x_3;$ 

Fill  $z_0$  --  $z_1$  --  $z_2$  --  $z_3$  --  $z_4$  --  $z_5$  -- bow up(6, 7) --  $z_8$  --  $z_9$  -- crescent left(10, 11)
  --  $z_{12}$  --  $z_{13}$  --  $z_{14}$  --  $z_{15}$  -- cycle;

fix_vstem( $px$ )(glyph_stored.glyph_name 1)(( $x > hv_0$ ) and ( $x < hv_1$ ));
fix_hstem( $py$ )(glyph_stored.glyph_name 1);
ghost_stem bot;
fix_dimens( $x_9 + \text{rightbear}$ ,  $y_9$ , 0, 0);

just_labels bot(0, 1, 3, 5, 8, 12, 14);
just_labels top(2, 4, 7, 9, 10, 13, 15);
just_labels lft(6, 11);

standard_exact_hsbw("f");
endglyph;

```

Construction of the character g:

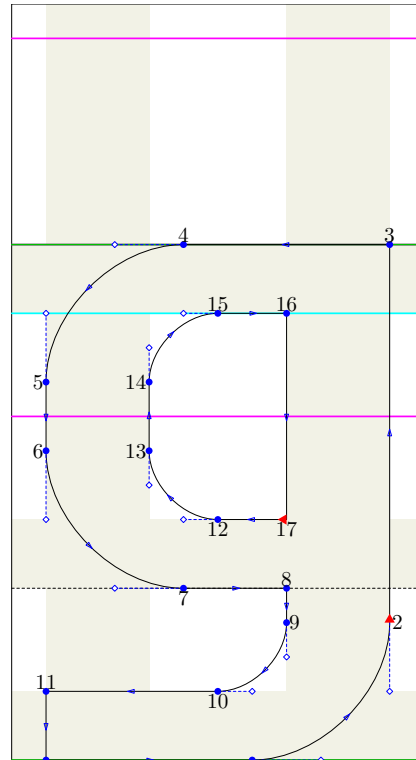

```

encode("g")(103); standard_introduce("g");
beginlyph(g);
 $y_0 = y_1 = \text{descender}; x_0 = x_5 = x_6 = x_{11} = \text{leftstemloc}; y_3 = y_4 = \text{lc.height};$ 
 $x_{14} - x_5 = x_{13} - x_6 = x_3 - x_{16} = x_2 - x_9 = px; x_{17} = x_8 = x_9;$ 
 $x_{17} - x_{12} = x_{16} - x_{15} = 2xu; y_7 = y_8 = 0;$ 
 $y_{11} - y_0 = y_{10} - y_1 = y_{17} - y_8 = y_{12} - y_7$ 
 $= y_4 - y_{15} = y_3 - y_{16} = py;$ 

 $z_2 = z_1 + (\text{obow}, \text{obow}); z_5 = z_4 - (\text{obow}, \text{obow}); z_7 = z_6 + (\text{obow}, -\text{obow});$ 
 $z_{10} = z_9 - (\text{ibow}, \text{ibow}); z_{13} = z_{12} + (-\text{ibow}, \text{ibow}); z_{15} = z_{14} + (\text{ibow}, \text{ibow});$ 

Fill  $z_0$  -- crescent right(1, 2) --  $z_3$  -- crescent left(4, 5) -- crescent down(6, 7)
  --  $z_8$  -- bow down(9, 10) --  $z_{11}$  -- cycle;
unFill bow left(12, 13) -- bow up(14, 15) --  $z_{16}$  --  $z_{17}$  -- cycle;

fix_vstem( $px$ )(glyph_stored.glyph_name 1, glyph_stored.glyph_name 2);
fix_hstem( $py$ )(glyph_stored.glyph_name 1, glyph_stored.glyph_name 2);
fix_dimens( $x_2 + \text{rightbear}, y_3, y_0, 0$ );

just_labels bot(0, 1, 7, 10, 12, 17);
just_labels top(3, 4, 8, 11, 15, 16);
just_labels rt(2, 9);
just_labels lft(5, 6, 13, 14);

standard_exact_hsbw("g");
endglyph;

```

Construction of the character h:

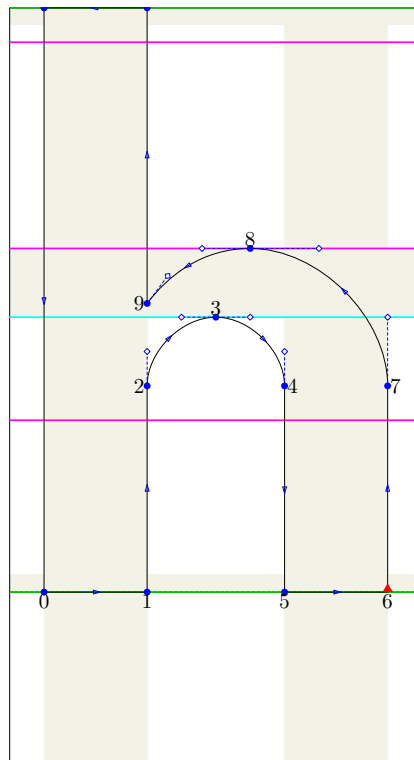

```

encode("h")(104); standard_introduce("h");
beginlyph(h);
y0 = y1 = y5 = y6 = 0; x0 = x11 = leftstemloc; y10 = y11 = ascender;
x1 - x0 = x10 - x11 = x6 - x5 = x7 - x4 = px; x2 = x1; x4 = x5; x9 = x10;
y8 = lc_height; y8 - y3 = py; y8 - y9 = .4obow;

z3 = z2 + (ibow, ibow); z4 = z3 + (ibow, -ibow); z8 = z7 + (-obow, obow);

Fill z0 -- z1 -- bow up(2, 3) & bow right(3, 4) -- z5 -- z6 -- crescent up(7, 8)
  .. controls(x8 - .7octl, y8) and (x9 + .3octl, y9 + .4octl) .. z9 -- z10
  -- z11 -- cycle;

fix_vstem(px)(glyph_stored.glyph_name 1);
fix_hstem(py)(glyph_stored.glyph_name 1);
ghost_stem top, bot;
fix_dimens(x6 + rightbear, y10, 0, 0);

just_labels bot(0, 1, 5, 6);
just_labels top(3, 8, 10, 11);
just_labels rt(4, 7);
just_labels lt(2, 9);

standard_exact_hsbw("h");
endglyph;

```

Construction of the character i:

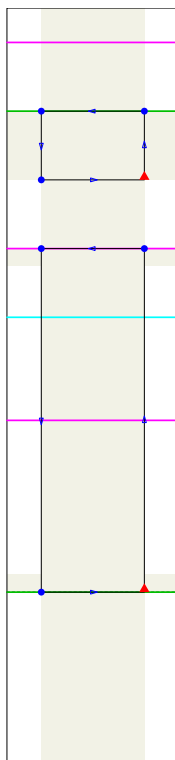

```

encode("i")(105); standard_introduce("i");
beginglyph(i);
use_accent(dotlessi, dotaccent);

fix_dimens(wd.dotlessi, ht.dotaccent, 0, 0);
standard_exact_hsbw("i");
endglyph;

```

Construction of the character dotlessj:

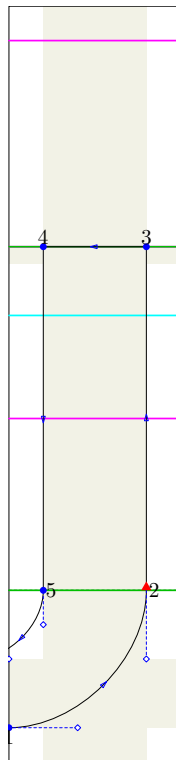

```

encode("dotlessj")(18); standard_introduce("dotlessj");
begin_glyph(dotlessj);
 $y_2 = y_5 = 0$ ;  $x_4 = x_5 = \text{leftstemloc}$ ;  $y_3 = y_4 = \text{lc\_height}$ ;
 $x_3 - x_4 = x_2 - x_5 = px$ ;  $x_6 - x_7 = xu$ ;  $x_0 = x_7$ ;  $y_0 = y_1$ ;  $y_7 - y_0 = py$ ;
 $z_2 = z_1 + (\text{obow}, \text{obow})$ ;  $z_6 = z_5 - (\text{ibow}, \text{ibow})$ ;
 $hv_0 := x_0$ ;
Fill  $z_0$  -- crescent right(1, 2) --  $z_3$  --  $z_4$  -- bow down(5, 6) --  $z_7$  -- cycle;
fix_vstem( $px$ )(glyph_stored.glyph_name 1)( $x > hv_0$ );
fix_hstem( $py$ )(glyph_stored.glyph_name 1);
fix_dimens( $x_2 + \text{rightbear}$ ,  $y_3$ , 0, 0);
ghost_stem top;
just_labels bot(0, 1, 6);
just_labels top(3, 4, 7);
just_labels rt(2, 5);
standard_exact_hsbw("dotlessj");
end_glyph;

```

Construction of the character j:

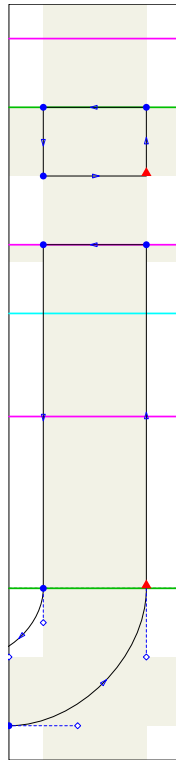

```

encode("j")(106); standard_introduce("j");
beginglyph(j);
%use_glyph(.dotlessj);
%use_glyph(.dotaccent)(wd..dotlessj-wd..dotaccent, 0);
use_accent(dotlessj, dotaccent);

fix_dimens(wd.dotlessj, ht.dotaccent, 0, 0);

standard_exact_hsbw("j");
endglyph;

```

Construction of the character k:

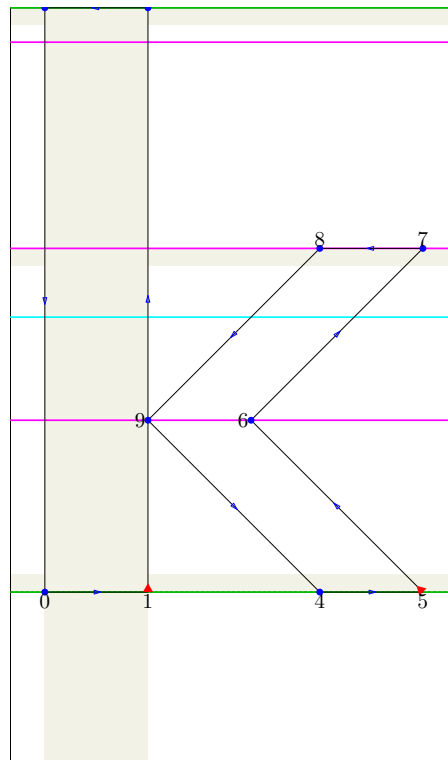

```

encode("k")(107); standard_introduce("k");
beginlyph(k);
 $y_0 = y_1 = y_4 = y_5 = 0; x_0 = x_3 = \text{leftstemloc}; y_2 = y_3 = \text{ascender};$ 
 $x_1 - x_0 = x_2 - x_3 = x_5 - x_4 = x_6 - x_9 = x_7 - x_8 = px;$ 
 $y_7 = y_8 = \text{lc\_height}; y_6 = y_9 = .5[y_4, y_8];$ 
 $x_8 - x_9 = x_4 - x_9 = y_8 - y_9; x_9 = x_1;$ 

Fill  $z_0$  --  $z_1$  --  $z_2$  --  $z_3$  -- cycle;
Fill  $z_4$  --  $z_5$  --  $z_6$  --  $z_7$  --  $z_8$  --  $z_9$  -- cycle;

fix_vstem( $px$ )(glyph_stored.glyph_name 1);
ghost_stem top, bot, top( $y_8$ );
fix_dimens( $x_5 + \text{rightbear}$ ,  $y_2$ , 0, 0);

just_labels bot(0, 1, 4, 5);
just_labels lft(6, 9);
just_labels top(2, 3, 7, 8);

standard_exact_hsbw("k");
endglyph;

```

Construction of the character l:

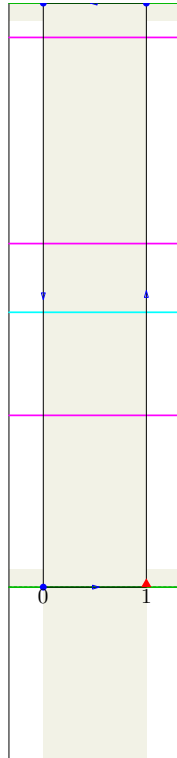

```

encode("l")(108); standard_introduce("l");
beginglyph(l);
 $y_0 = y_1 = 0$ ;  $x_0 = x_3 = \textit{leftstemloc}$ ;  $y_2 = y_3 = \textit{ascender}$ ;
 $x_2 - x_3 = x_1 - x_0 = \textit{px}$ ;
Fill  $z_0$  --  $z_1$  --  $z_2$  --  $z_3$  -- cycle;
fix_vstem( $\textit{px}$ )(glyph_stored.glyph_name 1);
fix_hstem( $\textit{py}$ )(glyph_stored.glyph_name 1);
fix_dimens( $x_1 + \textit{rightbear}$ ,  $y_2$ , 0, 0);
ghost_stem top, bot;
just_labels bot(0, 1);
just_labels top(2, 3);
standard_exact_hsbw("l");
endglyph;

```

Construction of the character slash:

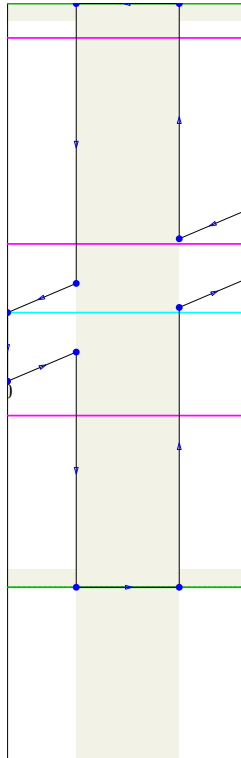

```

encode("lslash")(29); standard_introduce("lslash");
beginglyph(lslash);
 $x_0 = x_3 = \text{leftstemloc} - xu; y_3 = .5uc\_height;$ 
 $x_2 - x_3 = x_1 - x_0 = px + 2xu + 2xu;$ 
 $y_3 - y_0 = y_2 - y_1 = py; y_1 - y_3 = xu;$ 
find_outlines(glyph_stored.l 1 shifted (xu, 0),
  z_0 -- z_1 -- z_2 -- z_3 -- cycle)(glyph);
Fill glyph1;
use_stems(l)(xu, 0);
fix_dimens(x_1, ht.l, 0, 0);
just_labels bot(0);
just_labels rt(1);
just_labels top(2);
just_labels lft(3);
standard_exact_hsbw("lslash");
endglyph;

```

Construction of the character m:

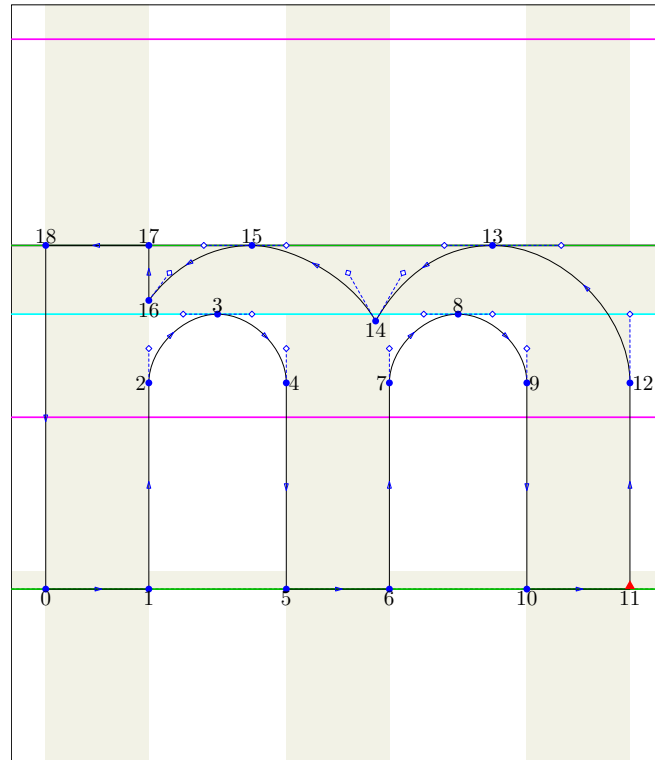

```

encode("m")(109); standard_introduce("m");
beginlyph(m);
 $y_0 = y_1 = y_5 = y_6 = y_{10} = y_{11} = 0$ ;  $x_0 = x_{18} = \text{leftstemloc}$ ;  $y_{13} = y_{15} = y_{17} = y_{18} = \text{lc\_height}$ ;
 $x_1 - x_0 = x_{17} - x_{18} = x_6 - x_5 = x_7 - x_4$ 
 $= x_{11} - x_{10} = x_{12} - x_9 = px$ ;
 $x_2 = x_1$ ;  $x_5 = x_4$ ;  $x_9 = x_{10}$ ;  $x_{16} = x_{17}$ ;
 $y_{15} - y_3 = y_{13} - y_8 = py$ ;
 $z_3 = z_2 + (\text{ibow}, \text{ibow})$ ;  $z_4 = z_3 + (\text{ibow}, -\text{ibow})$ ;  $z_8 = z_7 + (\text{ibow}, \text{ibow})$ ;  $z_9 = z_8 + (\text{ibow}, -\text{ibow})$ ;
 $z_{13} = z_{12} + (-\text{obow}, \text{obow})$ ;  $z_{14} = z_{13} - (.85\text{obow}, .55\text{obow})$ ;  $z_{16} = z_{15} - (\text{obow} - xu, .4\text{obow})$ ;

Fill  $z_0$  --  $z_1$  -- bow up(2, 3) & bow right(3, 4) --  $z_5$  --  $z_6$  -- bow up(7, 8)
  & bow right(8, 9) --  $z_{10}$  --  $z_{11}$  -- crescent up(12, 13)
  .. controls( $x_{13} - .7\text{octl}$ ,  $y_{13}$ ) and ( $x_{14} + .4\text{octl}$ ,  $y_{14} + .7\text{octl}$ ) ..  $z_{14}$ 
  .. controls( $x_{14} - .4\text{octl}$ ,  $y_{14} + .7\text{octl}$ ) and ( $x_{15} + .5\text{octl}$ ,  $y_{15}$ ) ..  $z_{15}$ 
  .. controls( $x_{15} - .7\text{octl}$ ,  $y_{15}$ ) and ( $x_{16} + .3\text{octl}$ ,  $y_{16} + .4\text{octl}$ ) ..  $z_{16}$  --  $z_{17}$ 
  --  $z_{18}$  -- cycle;
fix_vstem( $px$ )(glyph_stored.glyph_name 1);
fix_hstem( $py$ )(glyph_stored.glyph_name 1);
ghost_stem bot;
fix_dimens( $x_{11} + \text{rightbear}$ ,  $y_{13}$ , 0, 0);

vstem_triple := true;

just_labels bot(0, 1, 5, 6, 10, 11, 14, 16);
just_labels top(3, 8, 13, 15, 17, 18);
just_labels rt(4, 9, 12);
just_labels lt(2, 7);

standard_exact_hsbw("m");
endglyph;

```

Construction of the character n:

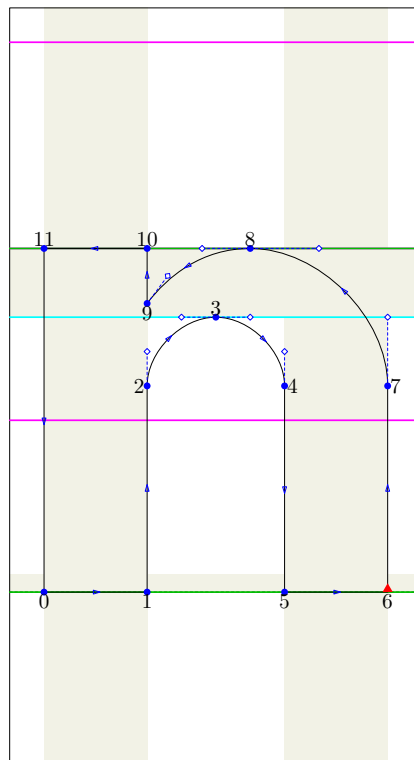

```

encode("n")(110); standard_introduce("n");
beginlyph(n);
 $y_0 = y_1 = y_5 = y_6 = 0; x_0 = x_{11} = \text{leftstemloc}; y_8 = y_{10} = y_{11} = \text{lc\_height};$ 
 $x_1 - x_0 = x_{10} - x_{11} = x_6 - x_5 = x_7 - x_4 = px; x_2 = x_1; x_4 = x_5; x_9 = x_{10};$ 
 $y_8 - y_3 = py; y_8 - y_9 = .4obow;$ 

 $z_3 = z_2 + (ibow, ibow); z_4 = z_3 + (ibow, -ibow); z_8 = z_7 + (-obow, obow);$ 

Fill  $z_0$  --  $z_1$  -- bow up(2, 3) & bow right(3, 4) --  $z_5$  --  $z_6$  -- crescent up(7, 8)
  .. controls( $x_8 - .7octl, y_8$ ) and ( $x_9 + .3octl, y_9 + .4octl$ ) ..  $z_9$  --  $z_{10}$  --  $z_{11}$  -- cycle;

fix_vstem( $px$ )(glyph_stored.glyph_name 1);
fix_hstem( $py$ )(glyph_stored.glyph_name 1);
ghost_stem bot;
fix_dimens( $x_6 + \text{rightbear}, y_8, y_0, 0$ );

just_labels bot(0, 1, 5, 6, 9);
just_labels top(3, 8, 10, 11);
just_labels lft(2);
just_labels rt(4, 7);

standard_exact_hsbw("n");
endglyph;

```

Construction of the character o:

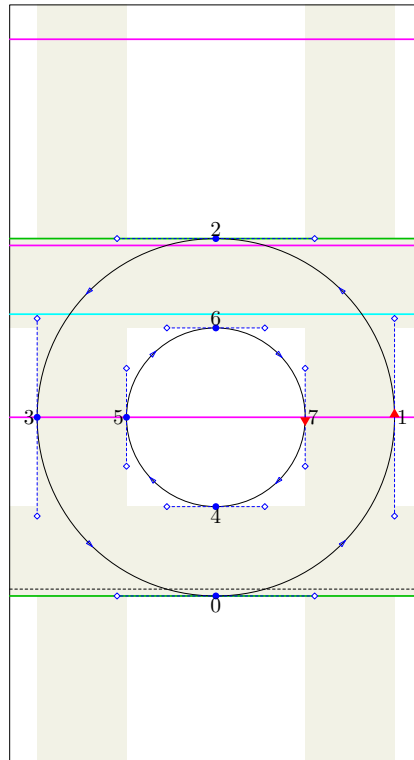

```

encode("o")(111); standard_introduce("o");
beginglyph(o);
 $y_0 = -o$ ;  $x_3 = \text{leftstemloc} - o$ ;  $y_2 = \text{lc\_height} + o$ ;
 $y_2 - y_6 = y_4 - y_0 = x_5 - x_3 = x_1 - x_7 = o + .48(py + px)$ ;
 $x_1 - x_3 = y_2 - y_0$ ;
 $x_2 = x_6 = x_4 = x_0 = .5[x_3, x_1]$ ;
 $y_3 = y_5 = y_7 = y_1 = .5[y_0, y_2]$ ;
Fill  $z_0 \dots z_1 \dots z_2 \dots z_3 \dots$  cycle;
unFill  $z_4 \dots z_5 \dots z_6 \dots z_7 \dots$  cycle;

fix_vstem( $o + .48(py + px)$ )(glyph_stored.glyph_name 1, glyph_stored.glyph_name 2);
fix_hstem( $o + .48(py + px)$ )(glyph_stored.glyph_name 1, glyph_stored.glyph_name 2);
fix_dimens( $x_1 + \text{rightbear} - o$ ,  $y_2$ ,  $y_0$ , 0);

just_labels bot(0, 4);
just_labels top(2, 6);
just_labels rt(1, 7);
just_labels lft(3, 5);

standard_exact_hsbw("o");
endglyph;

```

Construction of the character p:

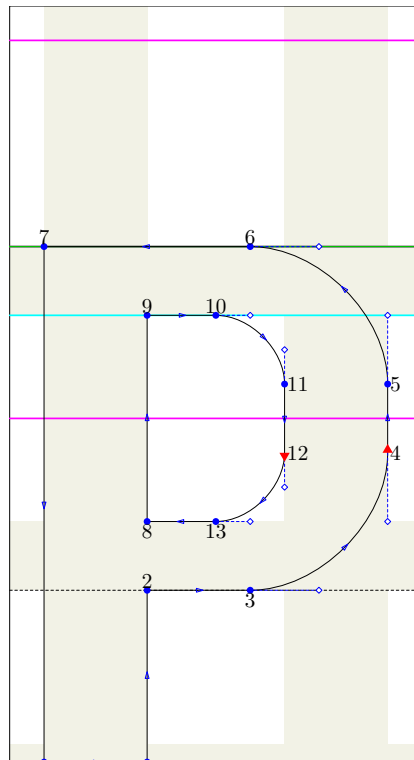

```

encode("p")(112); standard_introduce("p");
beginglyph(p);
y0 = y1 = descender; x0 = x7 = leftstemloc; y6 = y7 = lc_height;
x1 - x0 = x9 - x7 = x5 - x11 = x4 - x12 = px;
x1 = x2 = x8; x10 - x9 = x13 - x8 = 2xu;
y7 - y9 = y6 - y10 = y13 - y3 = y8 - y2 = py; y2 = y3 = 0;
z13 = z12 - (ibow, ibow);
z4 = z3 + (obow, obow); z6 = z5 + (-obow, obow); z11 = z10 + (ibow, -ibow);

Fill z0 -- z1 -- z2 -- crescent right(3, 4) -- crescent up(5, 6) -- z7 -- cycle;
unFill z8 -- z9 -- bow right(10, 11) -- bow down(12, 13) -- cycle;

fix_vstem(px)(glyph_stored.glyph_name 1, glyph_stored.glyph_name 2);
fix_hstem(py)(glyph_stored.glyph_name 1, glyph_stored.glyph_name 2);
ghost_stem bot;
fix_dimens(x4 + rightbear, y6, y0, 0);

just_labels bot(0, 1, 3, 8, 13);
just_labels top(2, 6, 7, 9, 10);
just_labels rt(4, 5, 11, 12);

standard_exact_hsbw("p");
endglyph;

```

Construction of the character q:

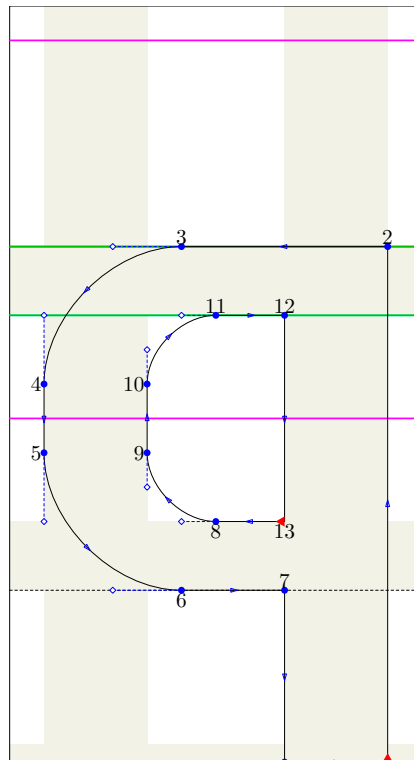

```

encode("q")(113); standard_introduce("q");
beginlyph(q);
 $y_0 = y_1 = \text{descender}$ ;  $x_4 = x_5 = \text{leftstemloc}$ ;  $y_2 = y_3 = \text{lc\_height}$ ;
 $x_{10} - x_4 = x_9 - x_5 = x_2 - x_{12} = x_1 - x_0 = px$ ;
 $x_7 = x_{13} = x_0$ ;  $x_{12} - x_{11} = x_{13} - x_8 = 2xu$ ;  $y_6 = y_7 = 0$ ;
 $y_3 - y_{11} = y_2 - y_{12} = y_8 - y_6 = y_{13} - y_7 = py$ ;
 $z_4 = z_3 - (\text{obow}, \text{obow})$ ;  $z_6 = z_5 + (\text{obow}, -\text{obow})$ ;  $z_9 = z_8 + (-\text{ibow}, \text{ibow})$ ;  $z_{11} = z_{10} + (\text{ibow}, \text{ibow})$ ;
Fill  $z_0$  --  $z_1$  --  $z_2$  -- crescent left(3, 4) -- crescent down(5, 6) --  $z_7$  -- cycle;
unFill bow left(8, 9) -- bow up(10, 11) --  $z_{12}$  --  $z_{13}$  -- cycle;

fix_vstem(px)(glyph_stored.glyph_name 1, glyph_stored.glyph_name 2);
fix_hstem(py)(glyph_stored.glyph_name 1, glyph_stored.glyph_name 2);
fix_dimens( $x_1 + \text{rightbear}$ ,  $y_2$ ,  $x_0$ , 0);
ghost_stem bot;

just_labels bot(0, 1, 6, 8, 13);
just_labels top(2, 3, 7, 11, 12);
just_labels lft(4, 5, 9, 10);

standard_exact_hsbw("q");
endglyph;

```

Construction of the character r:

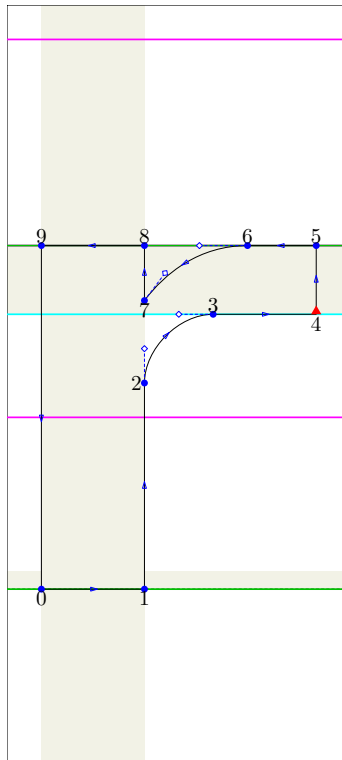

```

encode("r")(114); standard_introduce("r");
beginglyph(r);
y0 = y1 = 0; x0 = x9 = leftstemloc; y5 = y6 = y8 = y9 = lc_height;
x8 - x9 = x1 - x0 = px; x5 - x6 = 2xu; x4 = x5; x7 = x8; x2 = x1;
y5 - y4 = y6 - y3 = py;

z3 = z2 + (ibow, ibow); z7 = z6 - (obow - xu, .4obow);

Fill z0 -- z1 -- bow up(2, 3) -- z4 -- z5 -- z6 .. controls(x6 - .7octl, y6)
  and (x7 + .3octl, y7 + .4octl) .. z7 -- z8 -- z9 -- cycle;

fix_vstem(px)(glyph_stored.glyph_name 1);
fix_hstem(py)(glyph_stored.glyph_name 1);
ghost_stem bot;
fix_dimens(x4 + rightbear, y5, 0, 0);

just_labels bot(0, 1, 4, 7);
just_labels top(3, 5, 6, 8, 9);
just_labels lft(2);

standard_exact_hsbw("r");
endglyph;

```

Construction of the character s:

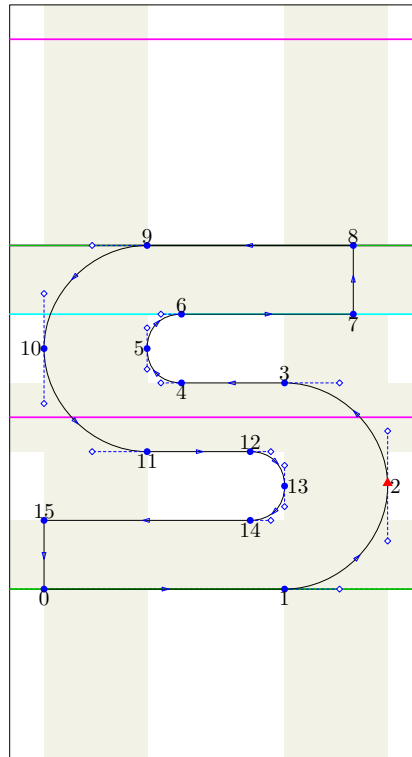

```

encode("s")(115); standard_introduce("s");
beginlyph(s);
 $y_0 = y_1 = 0; x_0 = x_{10} = x_{15} = \text{leftstemloc}; y_8 = y_9 = \text{lc\_height};$ 
 $x_5 - x_{10} = x_2 - x_{13} = px; x_8 = x_7 = x_2 - xu;$ 
 $x_{12} - x_4 = 2xu;$ 
 $y_{15} - y_0 = y_{14} - y_1 = y_8 - y_7 = y_9 - y_6 = py;$ 
 $z_2 = z_1 + (.75obow, .75obow); z_3 = z_2 + (-.75obow, .75obow);$ 
 $z_5 = z_4 + (-.5ibow, .5ibow); z_6 = z_5 + (.5ibow, .5ibow);$ 
 $z_{10} = z_9 - (.75obow, .75obow); z_{11} = z_{10} + (.75obow, -.75obow);$ 
 $z_{13} = z_{12} + (.5ibow, -.5ibow); z_{14} = z_{13} - (.5ibow, .5ibow);$ 
 $hh_0 := y_{14}; hh_1 := y_{12}; hh_2 := y_3; hh_3 := y_6;$ 
Fill  $z_0$  -- small_crescent right(1, 2) & small_crescent up(2, 3)
  -- small_bow left(4, 5) & small_bow up(5, 6) --  $z_7$  --  $z_8$ 
  -- small_crescent left(9, 10) & small_crescent down(10, 11)
  -- small_bow right(12, 13) & small_bow down(13, 14) --  $z_{15}$  -- cycle;

fix_vstem( $px$ )(glyph_stored.glyph_name 1);
fix_hstem( $py$ )(glyph_stored.glyph_name 1)(( $y \leq hh_0$ ) or ( $y \geq hh_3$ ));
fix_hstem( $py$ )(glyph_stored.glyph_name 1)(( $y \geq hh_1$ ) and ( $y \leq hh_2$ ));
fix_dimens( $x_2 + \text{rightbear}$ ,  $y_8$ , 0, 0);

just_labels bot(0, 1, 4, 7, 11, 14);
just_labels top(3, 6, 8, 9, 12, 15);
just_labels rt(2, 13);
just_labels lft(5, 10);

standard_exact_hsbw("s");
endglyph;

```

Construction of the character t:

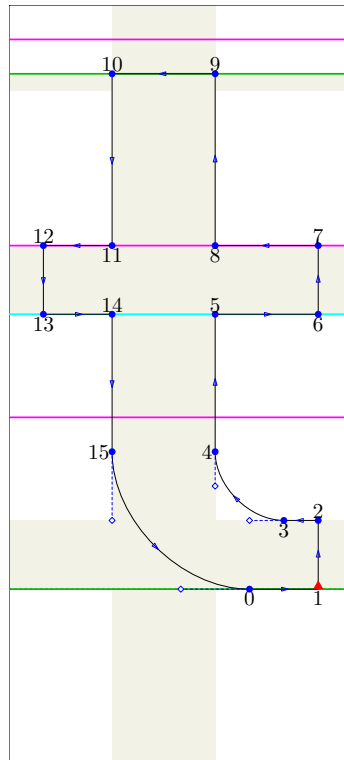

```

encode("t")(116); standard_introduce("t");
beginglyph(t);
 $y_0 = y_1 = 0; x_{12} = x_{13} = \text{leftstemloc}; y_9 = y_{10} = \text{ascender} - 2xu;$ 
 $x_9 - x_{10} = x_8 - x_{11} = x_5 - x_{14} = x_4 - x_{15} = px;$ 
 $x_{11} - x_{12} = x_{14} - x_{13} = 2xu; x_7 - x_8 = x_6 - x_5 = 3xu;$ 
 $x_{10} = x_{11}; x_{14} = x_{15}; y_7 = y_8 = y_{11} = y_{12} = \text{lc\_height};$ 
 $y_{12} - y_{13} = y_{11} - y_{14} = y_8 - y_5 = y_7 - y_6$ 
 $= y_2 - y_1 = y_3 - y_0 = py; x_2 = x_1 = x_6;$ 
 $hv_0 := x_{13}; hv_1 := x_6; z_4 = z_3 + (-\text{ibow}, \text{ibow}); z_0 = z_{15} + (\text{obow}, -\text{obow});$ 

Fill  $z_0$  --  $z_1$  --  $z_2$  -- bow left(3, 4) --  $z_5$  --  $z_6$  --  $z_7$  --  $z_8$  --  $z_9$  --  $z_{10}$  --  $z_{11}$  --  $z_{12}$ 
  --  $z_{13}$  --  $z_{14}$  -- crested down(15, 0) & cycle;

fix_vstem(px)(glyph_stored.glyph_name 1)(( $x > hv_0$ ) and ( $x < hv_1$ ));
fix_hstem(py)(glyph_stored.glyph_name 1);
ghost_stem bot, top;
fix_dimens( $x_1 + \text{rightbear}$ ,  $y_9$ , 0, 0);

just_labels bot(0, 1, 3, 6, 8, 11, 13);
just_labels top(2, 5, 7, 9, 10, 12, 14);
just_labels lft(4, 15);

standard_exact_hsbw("t");
endglyph;

```

Construction of the character u:

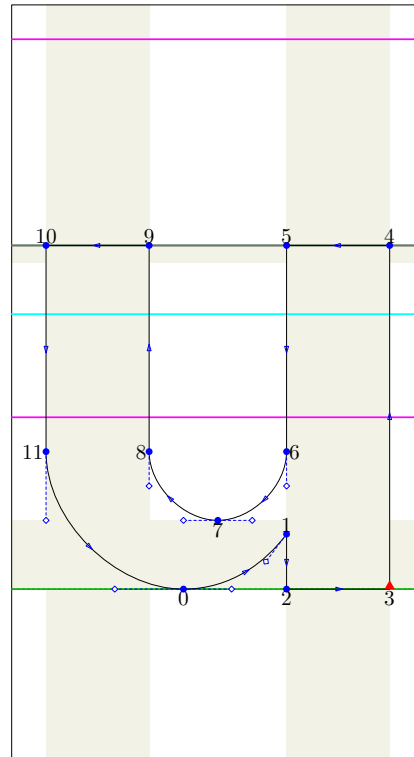

```

encode("u")(117); standard_introduce("u");
beginlyph(u);
 $y_0 = y_2 = y_3 = 0; x_{10} = x_{11} = \text{leftstemloc}; y_4 = y_5 = y_9 = y_{10} = \text{lc\_height};$ 
 $x_8 - x_{11} = x_9 - x_{10} = x_4 - x_5 = x_3 - x_2 = px; x_5 = x_6; x_1 = x_2; x_3 = x_4;$ 
 $y_7 - y_0 = py; y_1 - y_0 = .4obow;$ 

 $z_7 = z_6 - (ibow, ibow); z_8 = z_7 + (-ibow, ibow); z_0 = z_{11} + (obow, -obow);$ 

Fill  $z_0 \dots \text{controls}(x_0 + .7octl, y_0)$  and  $(x_1 - .3octl, y_1 - .4octl) \dots z_1$ 
  --  $z_2 \dots z_3 \dots z_4 \dots z_5$  -- bow down(6, 7) & bow left(7, 8)
  --  $z_9 \dots z_{10}$  -- crescent down(11, 0) & cycle;

fix_vstem(px)(glyph_stored.glyph_name 1);
fix_hstem(py)(glyph_stored.glyph_name 1);
ghost_stem top;
fix_dimens( $x_3 + \text{rightbear}, y_4, 0, 0$ );

just_labels bot(0, 2, 3, 7);
just_labels top(1, 4, 5, 9, 10);
just_labels lft(8, 11);
just_labels rt(6);

standard_exact_hsbw("u");
endglyph;

```

Construction of the character v:

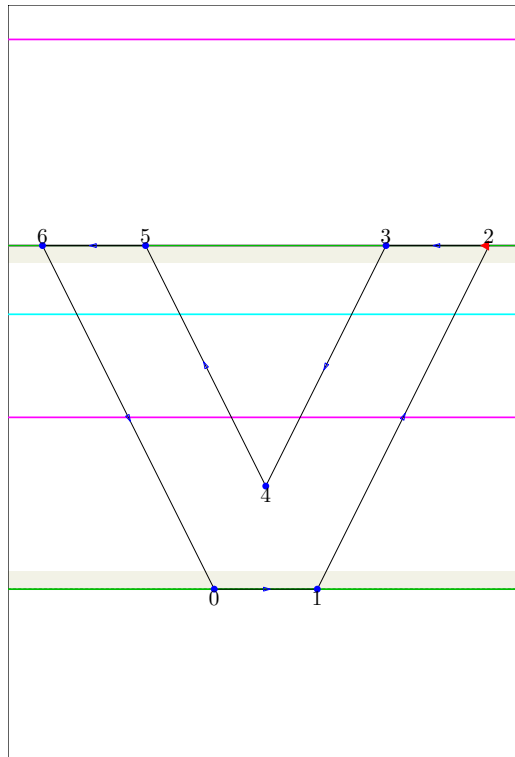

```

encode("v")(118); standard_introduce("v");
beginglyph(v);
 $y_0 = y_1 = 0; x_6 = \text{leftstemloc}; y_2 = y_3 = y_5 = y_6 = \text{lc\_height};$ 
 $x_1 - x_0 = x_2 - x_3 = x_5 - x_6 = px; x_0 - x_6 = x_2 - x_1 = 5xu;$ 
 $z_4 = \text{whatever}[z_1, z_5] = \text{whatever}[z_0, z_3];$ 
Fill  $z_0 \text{ -- } z_1 \text{ -- } z_2 \text{ -- } z_3 \text{ -- } z_4 \text{ -- } z_5 \text{ -- } z_6 \text{ -- cycle};$ 
fix_dimens( $x_2 + \text{rightbear}, y_2, 0, 0$ );
ghost_stem top, bot;
just_labels bot(0, 1, 4);
just_labels top(2, 3, 5, 6);
standard_exact_hsbw("v");
endglyph;

```

Construction of the character w:

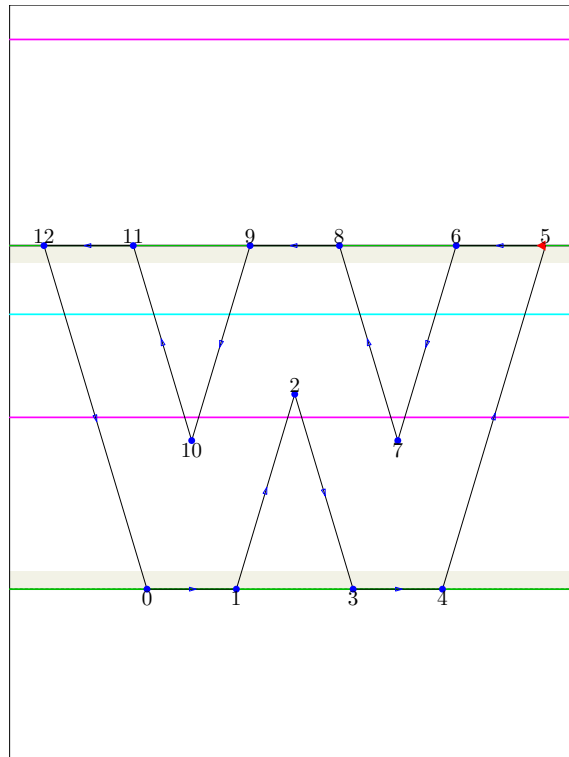

```
encode("w")(119); standard_introduce("w");
beginlyph(w);
```

```
 $y_0 = y_1 = y_3 = y_4 = 0; x_{12} = \text{leftstemloc}; y_5 = y_6 = y_8 = y_9 = y_{11} = y_{12} = \text{lc\_height};$ 
 $x_1 - x_0 = x_4 - x_3 = x_5 - x_6 = x_8 - x_9 = x_{11} - x_{12} = px - 2u;$ 
 $x_0 - x_{12} = x_8 - x_1 = x_3 - x_9 = x_5 - x_4 = 3xu;$ 
 $z_2 = \text{whatever}[z_1, z_8] = \text{whatever}[z_3, z_9];$ 
 $z_7 = \text{whatever}[z_3, z_6] = \text{whatever}[z_4, z_8];$ 
 $z_{10} = \text{whatever}[z_0, z_9] = \text{whatever}[z_1, z_{11}];$ 
```

```
Fill  $z_0 \text{ -- } z_1 \text{ -- } z_2 \text{ -- } z_3 \text{ -- } z_4 \text{ -- } z_5 \text{ -- } z_6 \text{ -- } z_7 \text{ -- } z_8 \text{ -- } z_9 \text{ -- } z_{10} \text{ -- } z_{11} \text{ -- } z_{12} \text{ -- cycle};$ 
```

```
ghost_stem bot, top;
fix_dimens( $x_5 + \text{rightbear}$ ,  $y_5$ , 0, 0);
```

```
just_labels bot(0, 1, 3, 4, 7, 10);
just_labels top(2, 5, 6, 8, 9, 11, 12);
```

```
standard_exact_hsbw("w");
endglyph;
```

Construction of the character x:

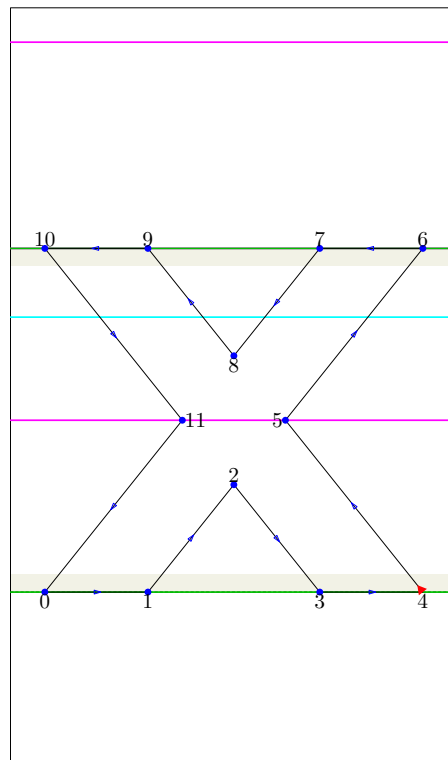

```

encode("x")(120); standard_introduce("x");
beginglyph(x);
 $y_0 = y_1 = y_3 = y_4 = 0$ ;  $x_0 = x_{10} = \text{leftstemloc}$ ;  $y_6 = y_7 = y_9 = y_{10} = \text{lc.height}$ ;
 $x_9 - x_{10} = x_6 - x_7 = x_4 - x_3 = x_1 - x_0 = px$ ;  $x_7 - x_0 = x_3 - x_{10} = 8xu$ ;
 $z_2 = \text{whatever}[z_1, z_6] = \text{whatever}[z_3, z_{10}]$ ;
 $z_5 = \text{whatever}[z_1, z_6] = \text{whatever}[z_4, z_9]$ ;
 $z_8 = \text{whatever}[z_0, z_7] = \text{whatever}[z_4, z_9]$ ;
 $z_{11} = \text{whatever}[z_0, z_7] = \text{whatever}[z_3, z_{10}]$ ;

Fill  $z_0$  --  $z_1$  --  $z_2$  --  $z_3$  --  $z_4$  --  $z_5$  --  $z_6$  --  $z_7$  --  $z_8$  --  $z_9$  --  $z_{10}$  --  $z_{11}$  -- cycle;

ghost_stem bot, top;
fix_dimens( $x_4 + \text{rightbear}$ ,  $y_6$ , 0, 0);

just_labels bot(0, 1, 3, 4, 8);
just_labels top(2, 6, 7, 9, 10);
just_labels lft(5);
just_labels rt(11);

standard_exact_hsbw("x");
endglyph;

```

Construction of the character y:

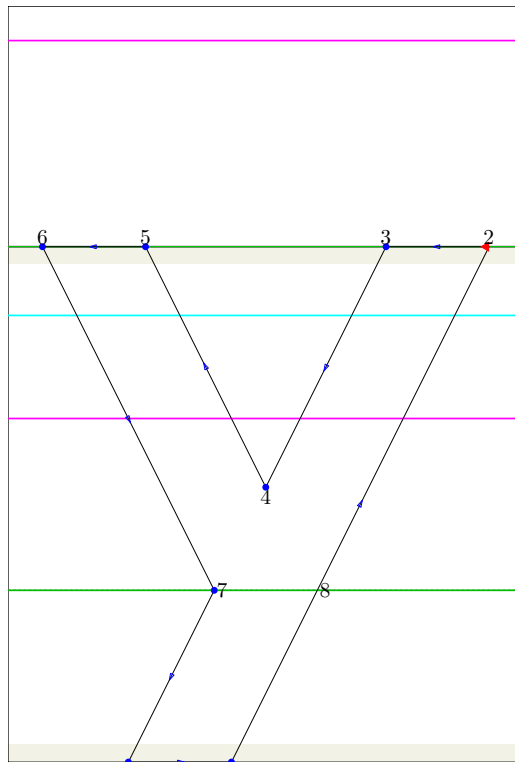

```

encode("y")(121); standard_introduce("y");
beginglyph(y);
y0 = y1 = descender; x6 = leftstemloc; y2 = y3 = y5 = y6 = lc.height;
x8 - x7 = x2 - x3 = x5 - x6 = x10 - x9 = px; y7 = y8 = 0;
y7 - y9 = y8 - y10 = y6 - y7; x7 - x6 = x7 - x9 = x2 - x8 = 5xu;
z4 = whatever[z8, z5] = whatever[z7, z3];
z0 = whatever[z9, z7]; z1 = whatever[z10, z8];

Fill z0 -- z1 -- z2 -- z3 -- z4 -- z5 -- z6 -- z7 -- cycle;

ghost_stem top, bot;
fix_dimens(x2 + rightbear, y2, 0, 0);

just_labels bot(0, 1, 4, 9, 10);
just_labels top(2, 3, 5, 6);
just_labels rt(7, 8);

standard_exact_hsbw("y");
endglyph;

```

Construction of the character `y.alt`:

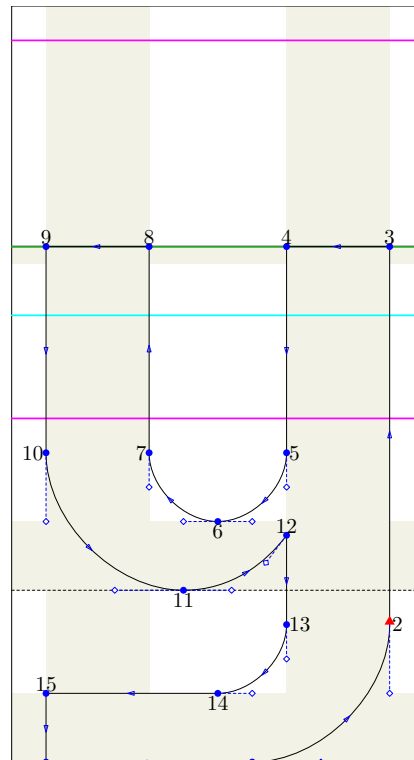

```

standard_introduce("y.alt");
beginlyph(y alt);
y0 = y1 = descender; x0 = x9 = x10 = x15 = leftstemloc; y3 = y4 = y8 = y9 = lc_height;
x7 - x10 = x8 - x9 = x3 - x4 = x2 - x13 = px; x4 = x5; x12 = x13; x2 = x3; y11 = 0;
y6 - y11 = y15 - y0 = y14 - y1 = py; y12 - y11 = .4obow;

z2 = z1 + (obow, obow); z6 = z5 - (ibow, ibow); z7 = z6 + (-ibow, ibow);
z11 = z10 + (obow, -obow); z14 = z13 - (ibow, ibow);

Fill z0 -- crescent right(1, 2) -- z3 -- z4 -- bow down(5, 6) & bow left(6, 7)
-- z8 -- z9 -- crescent down(10, 11) .. controls(x11 + .7octl, y11)
and (x12 - .3octl, y12 - .4octl) .. z12 -- bow down(13, 14) -- z15 -- cycle;

fix_vstem(px)(glyph_stored.glyph_name 1);
fix_hstem(py)(glyph_stored.glyph_name 1);
ghost_stem top;
fix_dimens(x2 + rightbear, y3, y0, 0);

just_labels bot(0, 1, 6, 11, 14);
just_labels top(3, 4, 8, 9, 12, 15);
just_labels lft(7, 10);
just_labels rt(2, 5, 13);

standard_exact_hsbw("y.alt");
endglyph;

```

Construction of the character z:

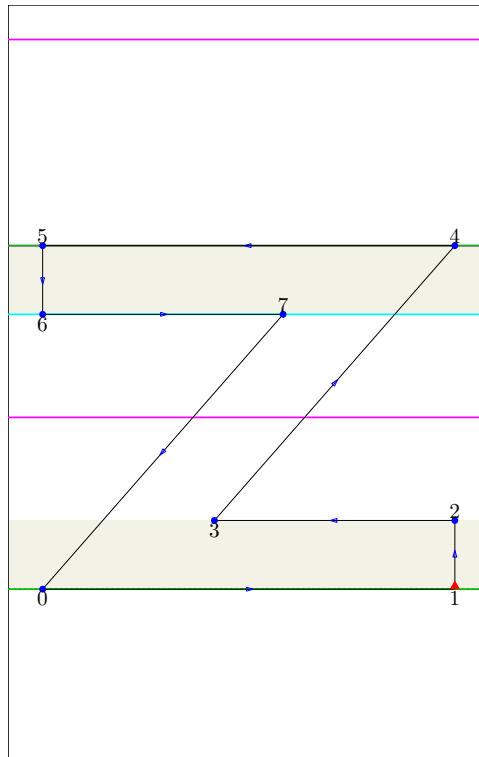

```

encode("z")(122); standard_introduce("z");
beginglyph(z);
 $y_0 = y_1 = 0$ ;  $x_0 = x_5 = x_6 = \textit{leftstemloc}$ ;  $y_4 = y_5 = \textit{lc\_height}$ ;
 $x_7 - x_6 = x_2 - x_3 = 7xu$ ;  $x_4 - x_7 = x_3 - x_0 = 5xu$ ;  $x_2 = x_1$ ;
 $y_5 - y_6 = y_4 - y_7 = y_2 - y_1 = y_3 - y_0 = py$ ;

Fill  $z_0 \text{ -- } z_1 \text{ -- } z_2 \text{ -- } z_3 \text{ -- } z_4 \text{ -- } z_5 \text{ -- } z_6 \text{ -- } z_7 \text{ -- cycle}$ ;

fix_hstem(py)(glyph_stored.glyph_name 1);
fix_dimens( $x_1 + \textit{rightbear}$ ,  $y_4$ , 0, 0);

just_labels bot(0, 1, 3, 6);
just_labels top(2, 4, 5, 7);

standard_exact_hsbw("z");
endglyph;

```

Construction of the character zcaron:

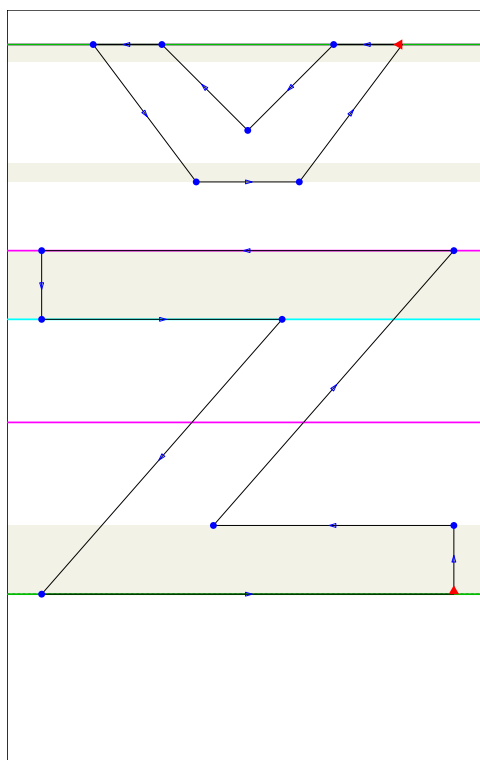

```

encode("zcaron")(31); standard_introduce("zcaron");
begin_glyph(zcaron);
use_accent(z, caron);

fix_dimens(wd.z, ht.caron, 0, 0);

standard_exact_hsbw("zcaron");
end_glyph;

```

Construction of the character braceleft:

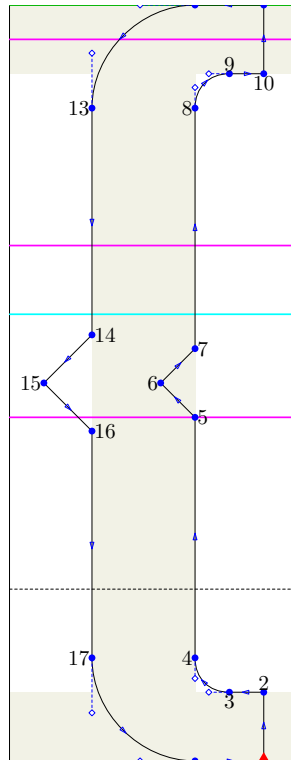

```

encode("braceleft")(123); standard_introduce("braceleft");
beginglyph(braceleft);
y0 = y1 = descender; x15 = leftstemloc; y12 = y11 = ascender;
x4 - x17 = x5 - x16 = x6 - x15 - 2u = x7 - x14 = x8 - x13 = px;
x10 - x9 = x2 - x3 = xu; x13 = x14; x16 = x17; x1 = x2; x10 = x11;
y11 - y10 = y12 - y9 = y2 - y1 = y3 - y0 = py; y6 = y15 = .5[y0, y12];
x5 - x6 = xu = y6 - y5 = y7 - y6;
y14 - y15 = y15 - y16 = x16 - x15 = x14 - x15;
z4 = z3 + (-.5ibow, .5ibow); z9 = z8 + (.5ibow, .5ibow);
z13 = z12 - (.75obow, .75obow); z0 = z17 + (.75obow, -.75obow);

Fill z0 -- z1 -- z2 -- small_bow left(3, 4) -- z5 -- z6 -- z7 -- small_bow up(8, 9)
-- z10 -- z11 -- small_crescent left(12, 13) -- z14 -- z15 -- z16
-- small_crescent down(17, 0) & cycle;

fix_vstem(px)(glyph_stored.glyph_name 1);
fix_hstem(py)(glyph_stored.glyph_name 1);
fix_dimens(x1 + rightbear, y11, y0, 0);

just_labels bot(0, 1, 3, 10);
just_labels top(2, 9, 11, 12);
just_labels rt(5, 7, 14, 16);
just_labels lft(4, 6, 8, 13, 15, 17);

standard_exact_hsbw("braceleft");
endglyph;

```

Construction of the character bar:

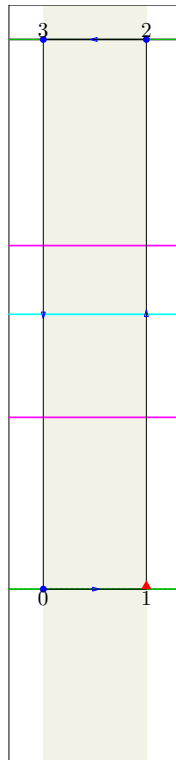

```

encode("bar")(124); standard_introduce("bar");
begin_glyph(bar);
 $y_0 = y_1 = 0$ ;  $x_0 = x_3 = \textit{leftstemloc}$ ;  $y_2 = y_3 = \textit{uc\_height}$ ;
 $x_2 - x_3 = x_1 - x_0 = \textit{px}$ ;
Fill  $z_0$  --  $z_1$  --  $z_2$  --  $z_3$  -- cycle;
fix_vstem( $\textit{px}$ )(glyph_stored.glyph_name 1);
fix_dimens( $x_1 + \textit{rightbear}$ ,  $y_2$ , 0, 0);
just_labels bot(0, 1);
just_labels top(2, 3);
standard_exact_hsbw("bar");
end_glyph;

```

Construction of the character `braceright`:

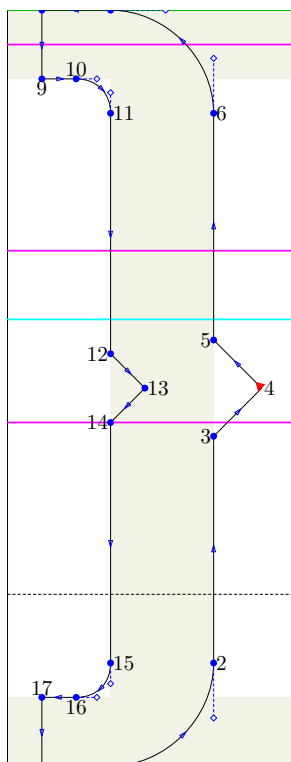

```
encode("braceright")(125); standard_introduce("braceright");
beginlyph(braceright);
```

```
 $y_0 = y_1 = \text{descender}; x_0 = x_8 = x_9 = x_{17} = \text{leftstemloc}; y_7 = y_8 = \text{ascender};$ 
```

```
 $x_2 - x_{15} = x_3 - x_{14} = x_4 - x_{13} - 2u = x_5 - x_{12} = x_6 - x_{11} = px;$ 
```

```
 $x_{10} - x_9 = x_{16} - x_{17} = xu; x_6 = x_5; x_3 = x_2;$ 
```

```
 $y_8 - y_9 = y_7 - y_{10} = y_{16} - y_1 = y_{17} - y_0 = py; y_4 = y_{13} = .5[y_0, y_7];$ 
```

```
 $x_{13} - x_{14} = xu = y_{12} - y_{13} = y_{13} - y_{14};$ 
```

```
 $y_5 - y_4 = y_4 - y_3 = x_4 - x_3 = x_4 - x_5;$ 
```

```
 $z_2 = z_1 + (.75obow, .75obow); z_7 = z_6 + (-.75obow, .75obow);$ 
```

```
 $z_{11} = z_{10} + (.5ibow, -.5ibow); z_{16} = z_{15} - (.5ibow, .5ibow);$ 
```

```
Fill  $z_0$  -- small_crescent right(1, 2) --  $z_3$  --  $z_4$  --  $z_5$  -- small_crescent up(6, 7) --  $z_8$  --  $z_9$ 
-- small_bow right(10, 11) --  $z_{12}$  --  $z_{13}$  --  $z_{14}$  -- small_bow down(15, 16)
--  $z_{17}$  -- cycle;
```

```
fix_vstem(px)(glyph_stored.glyph_name 1);
```

```
fix_hstem(py)(glyph_stored.glyph_name 1);
```

```
fix_dimens( $x_4 + \text{rightbear}$ ,  $y_7$ ,  $y_0$ , 0);
```

```
just_labels bot(0, 1, 9, 16);
```

```
just_labels top(7, 8, 10, 17);
```

```
just_labels rt(2, 4, 6, 11, 13, 15);
```

```
just_labels lft(3, 5, 12, 14);
```

```
standard_exact_hsbw("braceright");
```

```
endglyph;
```

Construction of the character asciitilde:

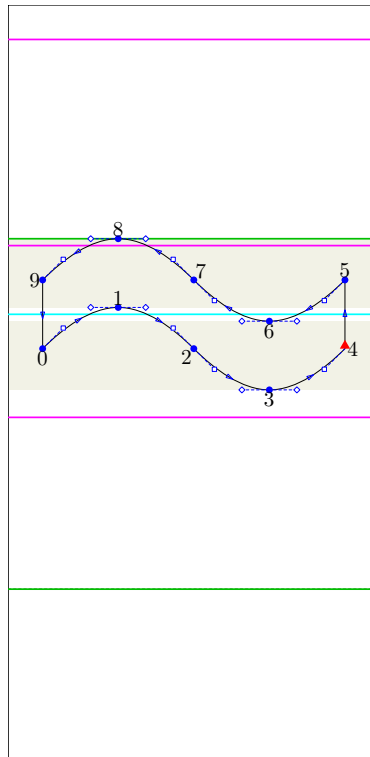

```

encode("asciitilde")(126); standard_introduce("asciitilde");
begin_glyph(asciitilde);
x0 = x9 = leftstemloc;
.5[y0, y9] = .5[y4, y5] = .5[y2, y7] = .5uc_height;
y1 - u = .5uc_height; y1 - y0 = y2 - y3;
y9 - y0 = y8 - y1 = y7 - y2 = y6 - y3 = y5 - y4 = py;
x8 - x9 = x1 - x0 = x7 - x8 = x2 - x1
= x6 - x7 = x3 - x2 = x5 - x6 = x4 - x3 = 2xu + u;

Fill z0 .. controls(x0 + 3u, y0 + 3u) and (x1 - xu + u, y1)
.. z1 .. controls(x1 + xu - u, y1) and (x2 - 3u, y2 + 3u)
.. z2 .. controls(x2 + 3u, y2 - 3u) and (x3 - xu + u, y3)
.. z3 .. controls(x3 + xu - u, y3) and (x4 - 3u, y4 - 3u) .. z4
-- z5 .. controls(x5 - 3u, y5 - 3u) and (x6 + xu - u, y6)
.. z6 .. controls(x6 - xu + u, y6) and (x7 + 3u, y7 - 3u)
.. z7 .. controls(x7 - 3u, y7 + 3u) and (x8 + xu - u, y8)
.. z8 .. controls(x8 - xu + u, y8) and (x9 + 3u, y9 + 3u)
.. z9 -- cycle;

fix_hstem(py)(glyph_stored.glyph_name 1);
fix_dimens(x4 + rightbear, y8, 0, 0);

just_labels bot(0, 3, 6);
just_labels top(1, 5, 8);
just_labels wrt(7);
just_labels lft(2);
just_labels rt(4);
just_labels lft(9);

standard_exact_hsbw("asciitilde");
end_glyph;

```

Construction of the character Euro:

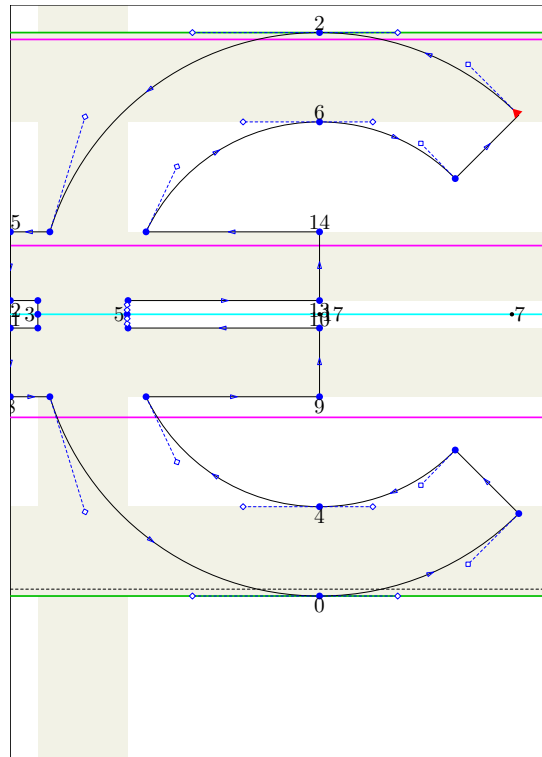

```

encode("Euro")(128); standard_introduce("Euro");
begin_glyph(Euro);
 $y_0 = -o$ ;  $x_3 = leftstemloc - o$ ;  $y_2 = uc\_height + o$ ;  $x_1 - x_3 = y_2 - y_0$ ;
 $y_4 - y_0 = x_1 - x_7 = y_2 - y_6 = x_5 - x_3 = o + .48(py + px)$ ;
 $y_3 = y_5 = y_7 = y_1 = .5[y_2, y_0] = y_{17}$ 
 $= .5[y_{11}, y_{12}] = .5[y_{10}, y_{13}]$ ;
 $x_2 = x_6 = x_4 = x_0 = .5[x_1, x_3] = x_{17} = x_{14} = x_{13} = x_{10} = x_9$ ;
 $x_{15} = x_{12} = x_{11} = x_8 = leftstemloc - xu$ ;  $y_{12} - y_{11} = y_{13} - y_{10} = xu - u$ ;
 $y_{15} - y_{12} = y_{14} - y_{13} = y_{10} - y_9 = y_{11} - y_8 = py$ ;  $x_1 - x_{18} = x_1 - x_{16} = xu + o$ ;
 $y_{16} - y_0 = y_2 - y_{18} = xu + o$ ;  $z_{19} = z_1 + (xu, 0)$ ;

find_outlines( $z_0 \dots z_1 \dots z_2 \dots z_3 \dots cycle$ ,  $z_{16} \text{ -- } z_{17} \text{ -- } z_{18} \text{ -- } z_{19} \text{ -- } cycle$ )(glyph);
find_outlines(glyph1,  $z_4 \dots z_5 \dots z_6 \dots z_7 \dots cycle$ )(glyph);
find_outlines(glyph1,  $z_8 \text{ -- } z_9 \text{ -- } z_{10} \text{ -- } z_{11} \text{ -- } cycle$ )(glyph);
find_outlines(glyph1,  $z_{12} \text{ -- } z_{13} \text{ -- } z_{14} \text{ -- } z_{15} \text{ -- } cycle$ )(glyph);

Fill glyph1;

fix_vstem( $o + .48(py + px)$ )(glyph_stored.glyph_name 1);
fix_hstem( $o + .48(py + px)$ )(glyph_stored.glyph_name 1);
fix_hstem(py)(glyph_stored.glyph_name 1);
fix_dims( $round(x_7 + u + rightbear)$ ,  $y_2, y_0, 0$ );

just_labels bot(0, 4, 8, 9, 12, 13);
just_labels top(2, 6, 10, 11, 14, 15);
just_labels lft(3, 5);
dot_labels rt(1, 7, 16, 17, 18, 19);

standard_exact_hsbw("Euro");
end_glyph;

```

Construction of the character quotesinglbase:

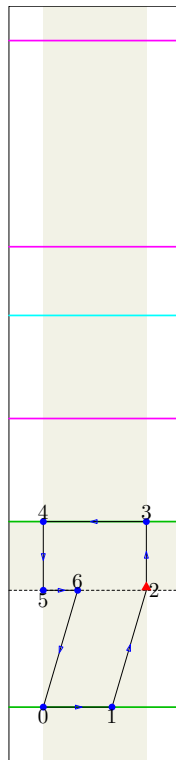

```

encode("quotesinglbase")(130); standard_introduce("quotesinglbase");
beginglyph(quotesinglbase);
 $y_2 = y_5 = y_6 = 0$ ;  $x_0 = x_4 = x_5 = \textit{leftstemloc}$ ;
 $x_2 - x_5 = x_3 - x_4 = px$ ;  $x_2 - x_6 = x_1 - x_0 = 2xu$ ;
 $y_4 - y_5 = y_3 - y_2 = py$ ;
 $y_6 - y_0 = y_2 - y_1 = 3xu + 2u$ ;
Fill  $z_0$  --  $z_1$  --  $z_2$  --  $z_3$  --  $z_4$  --  $z_5$  --  $z_6$  -- cycle;
fix_vstem( $px$ )(glyph_stored.glyph_name 1);
fix_hstem( $py$ )(glyph_stored.glyph_name 1);
fix_dimens( $x_2 + \textit{rightbear}$ ,  $y_3$ ,  $y_0$ , 0);
just_labels bot(0, 1, 5);
just_labels top(3, 4, 6);
just_labels rt(2);
standard_exact_hsbw("quotesinglbase");
endglyph;

```

Construction of the character florin:

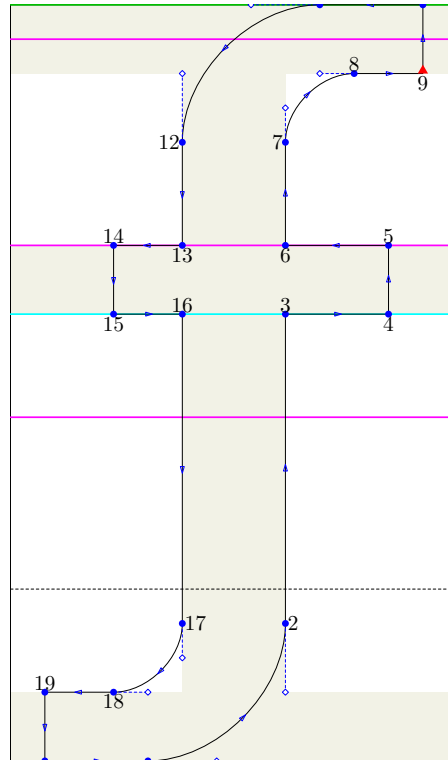

```

encode("florin")(131); standard_introduce("florin");
beginlyph(florin);
 $y_0 = y_1 = \text{descender}; x_0 = x_{19} = \text{leftstemloc}; y_{10} = y_{11} = \text{ascender};$ 
 $x_2 - x_{17} = x_3 - x_{16} = x_6 - x_{13} = x_7 - x_{12} = px; x_{13} - x_{14} = x_{16} - x_{15} = 2xu; x_5 - x_6 = x_4 - x_3 = 3xu;$ 
 $x_9 - x_8 = x_{18} - x_{19} = 2xu; x_{10} = x_9; x_{12} = x_{13} = x_{16} = x_{17};$ 
 $y_{19} - y_0 = y_{18} - y_1 = y_{14} - y_{15} = y_{13} - y_{16} = y_6 - y_3$ 
 $= y_5 - y_4 = y_{11} - y_8 = y_{10} - y_9 = py; y_{14} = y_{13} = y_6 = y_5 = \text{lc\_height};$ 
 $z_2 = z_1 + (\text{obow}, \text{obow}); z_8 = z_7 + (\text{ibow}, \text{ibow}); z_{12} = z_{11} - (\text{obow}, \text{obow}); z_{18} = z_{17} - (\text{ibow}, \text{ibow});$ 
 $hv_0 := x_4;$ 

Fill  $z_0$  -- crescent right(1, 2) --  $z_3$  --  $z_4$  --  $z_5$  --  $z_6$  -- bow up(7, 8) --  $z_9$  --  $z_{10}$ 
  -- crescent left(11, 12) --  $z_{13}$  --  $z_{14}$  --  $z_{15}$  --  $z_{16}$  -- bow down(17, 18) --  $z_{19}$  -- cycle;

fix_vstem( $px$ )(glyph_stored.glyph_name 1)( $x < hv_0$ );
fix_hstem( $py$ )(glyph_stored.glyph_name 1);
fix_dimens( $x_9 + \text{rightbear}, y_{10}, y_0, 0$ );

just_labels bot(0, 1, 4, 6, 9, 13, 15, 18);
just_labels top(3, 5, 8, 10, 11, 14, 16, 19);
just_labels rt(2, 17);
just_labels lft(7, 12);

standard_exact_hsbw("florin");
endglyph;

```

Construction of the character `quotedblbase`:

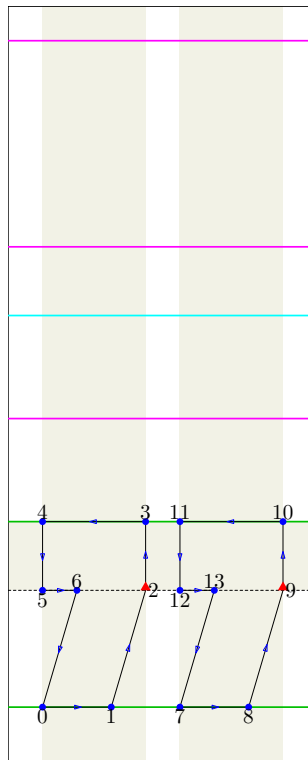

```
encode("quotedblbase")(132); standard_introduce("quotedblbase");
beginlyph(quotedblbase);
```

```
 $y_2 = y_5 = y_6 = y_9 = y_{12} = y_{13} = 0$ ;  $x_0 = x_4 = x_5 = \textit{leftstemloc}$ ;  $x_7 = x_{12} = x_{11}$ ;
 $x_2 - x_5 = x_3 - x_4 = x_{10} - x_{11} = x_9 - x_{12} = px$ ;  $x_2 - x_6 = x_1 - x_0 = x_9 - x_{13} = x_8 - x_7 = 2xu$ ;  $x_{11} - x_3 = xu$ ;
 $y_4 - y_5 = y_3 - y_2 = y_{10} - y_9 = y_{11} - y_{12} = py$ ;
 $y_6 - y_0 = y_2 - y_1 = y_9 - y_8 = y_{13} - y_7 = 3xu + 2u$ ;
```

```
Fill  $z_0 \text{ -- } z_1 \text{ -- } z_2 \text{ -- } z_3 \text{ -- } z_4 \text{ -- } z_5 \text{ -- } z_6 \text{ -- cycle}$ ,
 $z_7 \text{ -- } z_8 \text{ -- } z_9 \text{ -- } z_{10} \text{ -- } z_{11} \text{ -- } z_{12} \text{ -- } z_{13} \text{ -- cycle}$ ;
```

```
fix_vstem(px)(glyph_stored.glyph_name 1, glyph_stored.glyph_name 2);
fix_hstem(py)(glyph_stored.glyph_name 1, glyph_stored.glyph_name 2);
fix_dimens(x_9 + rightbear, y_{10}, y_0, 0);
```

```
just_labels bot(0, 1, 5, 7, 8, 12);
just_labels top(3, 4, 6, 10, 11, 13);
just_labels rt(2, 9);
```

```
standard_exact_hsbw("quotedblbase");
endglyph;
```

Construction of the character ellipsis:

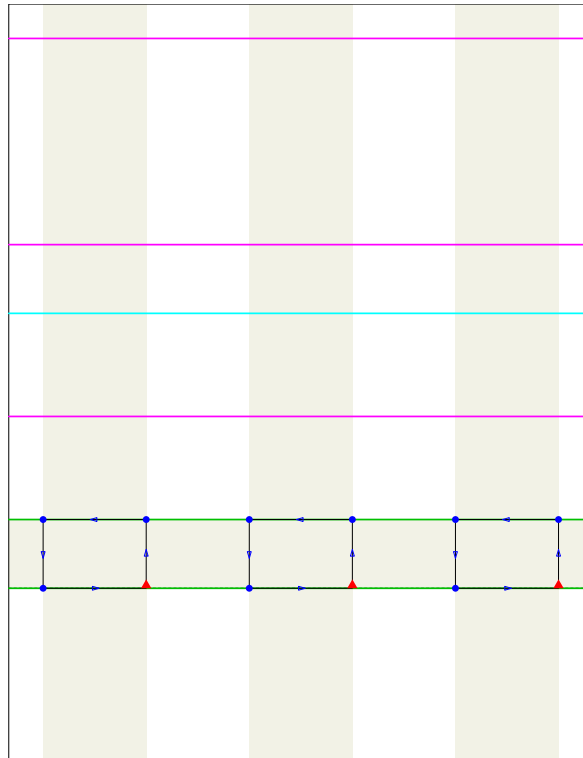

```

encode("ellipsis")(133); standard_introduce("ellipsis");
begin_glyph(ellipsis);
use_glyph(period);
use_glyph(period)(wd.period + xu, 0);
use_glyph(period)(2wd.period + 2xu, 0);
fix_dimens(3wd.period + 2xu, ht.period, dp.period, 0);

vstem_triple := true;

standard_exact_hsbw("ellipsis");
end_glyph;

```

Construction of the character dagger:

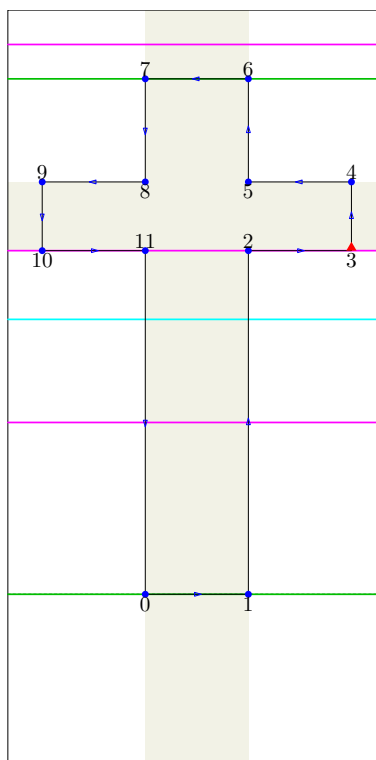

```

encode("dagger")(134); standard_introduce("dagger");
beginglyph(dagger);
 $y_0 = y_1 = 0$ ;  $x_9 = x_{10} = \textit{leftstemloc}$ ;  $y_6 = y_7 = \textit{lc\_height} - \textit{descender}$ ;
 $x_6 - x_7 = x_5 - x_8 = x_2 - x_{11} = x_1 - x_0 = \textit{px}$ ;
 $x_8 - x_9 = x_{11} - x_{10} = x_4 - x_5 = x_3 - x_2 = 3\textit{xu}$ ;  $x_7 = x_8$ ;  $x_{11} = x_0$ ;
 $y_{10} = y_{11} = y_2 = y_3 = \textit{lc\_height}$ ;
 $y_9 - y_{10} = y_8 - y_{11} = y_5 - y_2 = y_4 - y_3 = \textit{py}$ ;
 $h_{v_0} := x_9$ ;  $h_{v_1} := x_3$ ;

Fill  $z_0 -- z_1 -- z_2 -- z_3 -- z_4 -- z_5 -- z_6 -- z_7 -- z_8 -- z_9 -- z_{10} -- z_{11} -- \textit{cycle}$ ;

fix_vstem( $\textit{px}$ )( $\textit{glyph\_stored.glyph\_name}$  1)(( $x > h_{v_0}$ ) and ( $x < h_{v_1}$ ));
fix_hstem( $\textit{py}$ )( $\textit{glyph\_stored.glyph\_name}$  1);
fix_dims( $x_3 + \textit{rightbear}$ ,  $y_6$ , 0, 0);

just_labels bot(0, 1, 3, 5, 8, 10);
just_labels top(2, 4, 6, 7, 9, 11);

standard_exact_hsbw("dagger");
endglyph;

```

Construction of the character daggerdbl:

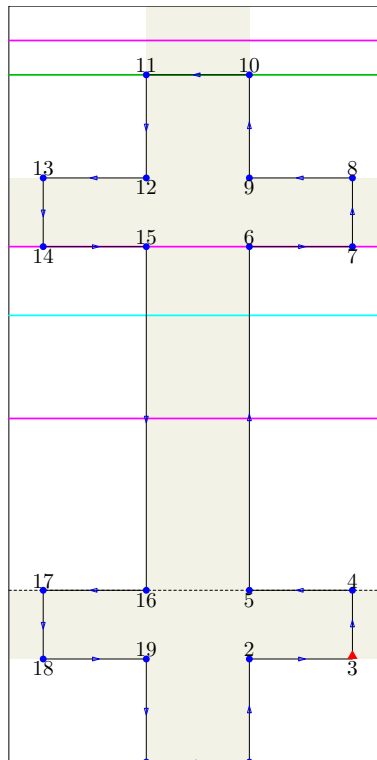

```

encode("daggerdbl")(135); standard_introduce("daggerdbl");
beginlyph(daggerdbl);
 $y_4 = y_5 = y_{16} = y_{17} = 0$ ;  $x_{13} = x_{14} = x_{17} = x_{18} = \text{leftstemloc}$ ;
 $x_{10} - x_{11} = x_9 - x_{12} = x_6 - x_{15}$ 
 $= x_5 - x_{16} = x_2 - x_{19} = x_1 - x_0 = px$ ;
 $x_{12} - x_{13} = x_{15} - x_{14} = x_{16} - x_{17} = x_{19} - x_{18}$ 
 $= x_8 - x_9 = x_7 - x_6 = x_4 - x_5 = x_3 - x_2 = 3xu$ ;  $x_{11} = x_{12}$ ;  $x_0 = x_{19}$ ;
 $y_0 = y_1 = \text{descender}$ ;
 $y_6 = y_7 = y_{14} = y_{15} = \text{lc\_height}$ ;
 $y_{13} - y_{14} = y_{12} - y_{15} = y_9 - y_6 = y_8 - y_7$ 
 $= y_{17} - y_{18} = y_{16} - y_{19} = y_5 - y_2 = y_4 - y_3 = py$ ;
 $y_{19} - y_0 = y_{10} - y_9 = y_{11} - y_{12}$ ;
 $hv_0 := x_{18}$ ;  $hv_1 := x_3$ ;

Fill  $z_0 \text{ -- } z_1 \text{ -- } z_2 \text{ -- } z_3 \text{ -- } z_4 \text{ -- } z_5 \text{ -- } z_6 \text{ -- } z_7 \text{ -- } z_8 \text{ -- } z_9 \text{ -- } z_{10} \text{ -- } z_{11}$ 
 $\text{ -- } z_{12} \text{ -- } z_{13} \text{ -- } z_{14} \text{ -- } z_{15} \text{ -- } z_{16} \text{ -- } z_{17} \text{ -- } z_{18} \text{ -- } z_{19} \text{ -- cycle}$ ;

fix_vstem( $px$ )(glyph_stored.glyph_name 1)(( $x > hv_0$ ) and ( $x < hv_1$ ));
fix_hstem( $py$ )(glyph_stored.glyph_name 1);
fix_dimens( $x_3 + \text{rightbear}$ ,  $y_{10}$ ,  $y_0$ , 0);

just_labels bot(0, 1, 3, 5, 7, 9, 12, 14, 16, 18);
just_labels top(2, 4, 6, 8, 10, 11, 13, 15, 17, 19);

standard_exact_hsbw("daggerdbl");
endglyph;

```

Construction of the character circumflex:

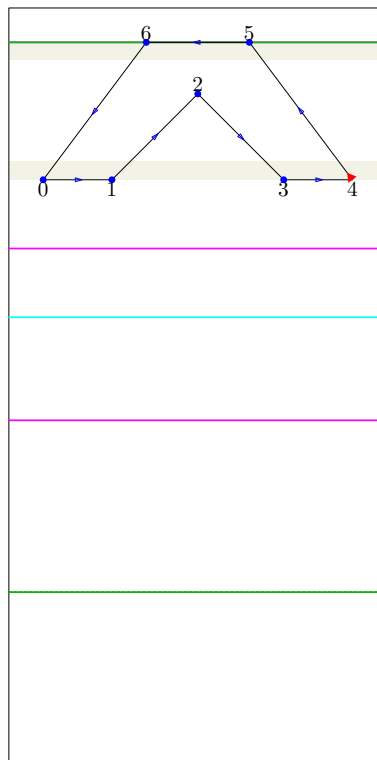

```

encode("circumflex")(136); standard_introduce("circumflex");
begin_glyph(circumflex);
x_0 = leftstemloc;
x_5 - x_6 = px = x_1 - x_0 + xu = x_4 - x_3 + xu; y_6 - y_0 = y_5 - y_4 = 4xu;
x_6 - x_0 = x_4 - x_5 = 3xu;
y_0 = y_1 = y_3 = y_4 = lc_height + 2xu;
z_2 = whatever[z_1, z_5] = whatever[z_3, z_6];

Fill z_0 -- z_1 -- z_2 -- z_3 -- z_4 -- z_5 -- z_6 -- cycle;

ghost_stem top, bot;
fix_dimens(x_4 + rightbear, y_5, 0, 0);

just_labels bot(0, 1, 3, 4);
just_labels top(2, 5, 6);

standard_exact_hsbw("circumflex");
end_glyph;

```

Construction of the character perthousand:

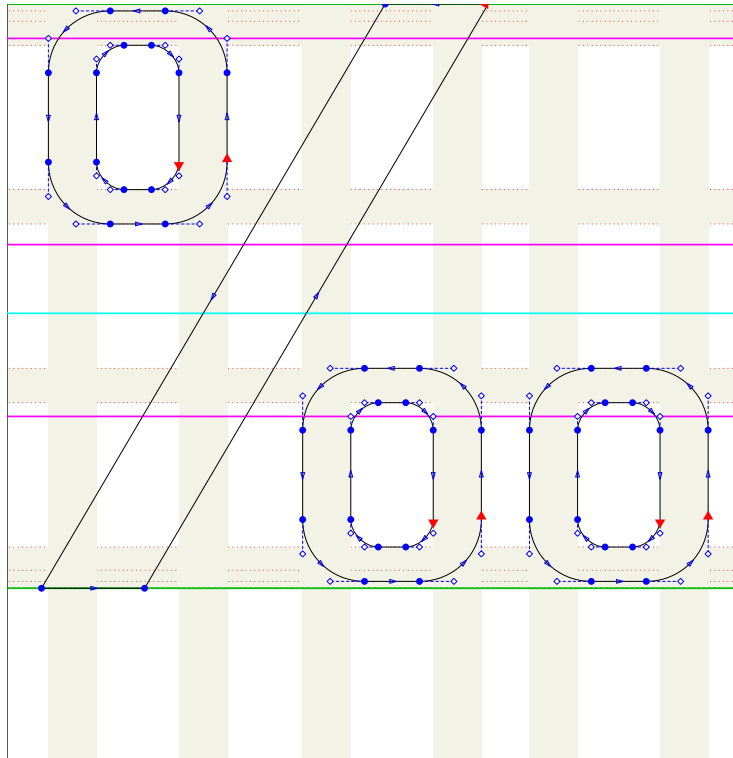

```

encode("perthousand")(137); standard_introduce("perthousand");
beginglyph (perthousand);
use_glyph(fraction);
use_glyph(zerosuperior)(u, ascender - uc_height - u);
use_glyph(zerosuperior)(wd.fraction - wd.zerosuperior - u, -lc_height + u + u);
use_glyph(zerosuperior)(wd.fraction - rightbear + u, -lc_height + u + u);
fix_dimens(wd.fraction + wd.zerosuperior - rightbear + u, ht.fraction, 0, 0);
ghost_stem bot, top;
standard_exact_hsbw("perthousand");
endglyph;

```

Construction of the character Scaron:

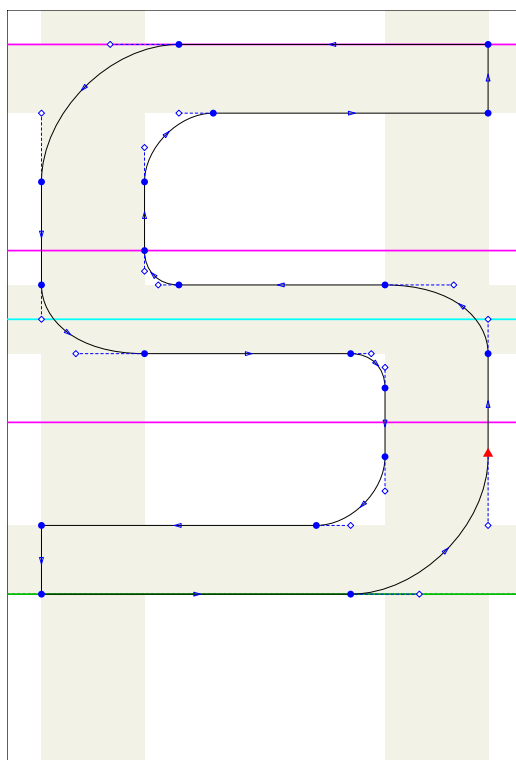

```

encode("Scaron")(138); standard_introduce("Scaron");
begin_glyph(Scaron);
use_accent(S, caron);

fix_dimens(wd.S, ht.S + ht.caron - lc_height, 0, 0);

standard_exact_hsbw("Scaron");
end_glyph;

```

Construction of the character `guilsinglleft`:

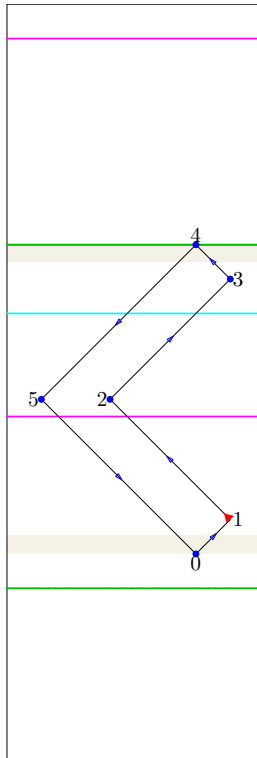

```

encode("guilsinglleft")(139); standard_introduce("guilsinglleft");
begin_glyph(guilsinglleft);
 $y_0 = xu$ ;  $x_5 = leftstemloc$ ;  $y_4 = lc\_height$ ;
 $x_2 - x_5 = 2xu$ ;  $y_5 = y_2 = .5[y_0, y_4]$ ;
 $x_4 - x_5 = x_0 - x_5 = y_5 - y_0$ ;
 $z_1 = z_0 + (xu, xu)$ ;  $z_3 = z_4 + (xu, -xu)$ ;
Fill  $z_0$  --  $z_1$  --  $z_2$  --  $z_3$  --  $z_4$  --  $z_5$  -- cycle;
ghost_stem top, bot;
fix_dimens( $x_1 + rightbear$ ,  $y_4$ , 0, 0);

just_labels bot(0);
just_labels top(4);
just_labels rt(1, 3);
just_labels lft(2, 5);
standard_exact_hsbw("guilsinglleft");
end_glyph;

```

Construction of the character OE:

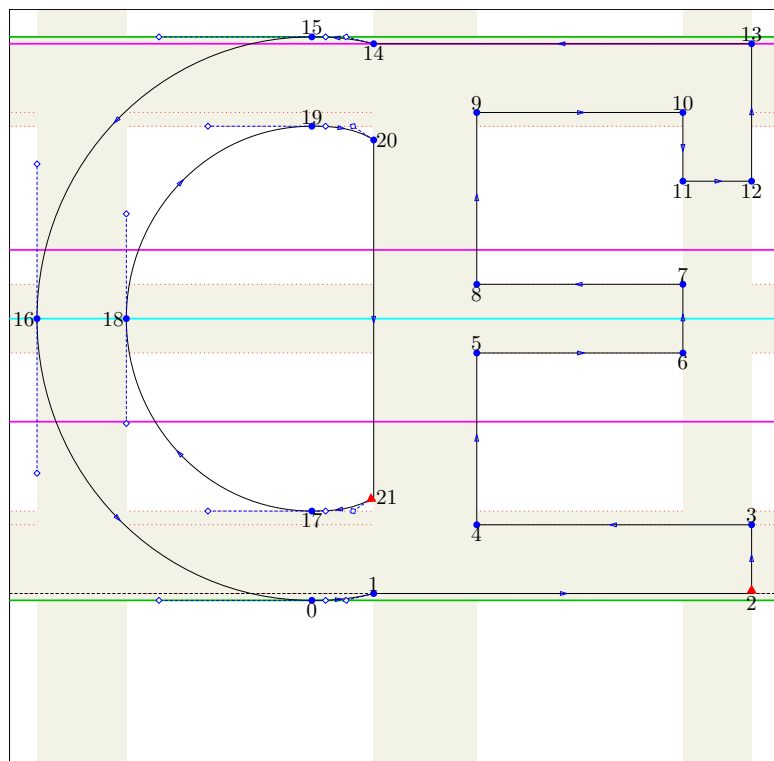

```

encode("OE")(140); standard_introduce("OE");
beginlyph(OE);
y0 = -o; y1 = y2 = 0; x16 = leftstemloc - o; y15 = uc_height + o; y13 = y14 = uc_height;
x15 = x19 = x17 = x0 = y16 + x16; y16 = y18 = .5[y0, y15];
x14 - x15 = x20 - x19 = x21 - x17 = x1 - x0 = 2xu - u;
x6 - x5 = x7 - x8 = x10 - x9 = 6xu; x10 = x11;
x3 - x6 = x12 - x11 = x13 - x10 = xgap; x2 = x3;
.5[y5, y8] = .5[y6, y7] = .5uc_height;
y7 - y6 = y8 - y5 = y3 - y2 = y4 - y1 = y14 - y9 = y13 - y10 = py; y10 - y11 = 2xu; y12 = y11;
y14 - y20 = y21 - y1 = o + .48(py + px) + u;
y9 - x14 = x8 - x20 = x5 - x21 = x4 - x1 = px;
y17 - y0 = y15 - y19 = x18 - x16 = o + .48(py + px);
hh0 := y11; hh1 := y9;
Fill z0 .. controls(x0 + 2u, y0) and (x1 - 4u, y1 - u) .. z1 -- z2 -- z3 -- z4 -- z5
-- z6 -- z7 -- z8 -- z9 -- z10 -- z11 -- z12 -- z13 -- z14 .. controls(x14 - 4u, y14 + u)
and (x15 + 2u, y15) .. z15 .. z16 .. cycle;
unFill z17 .. z18 .. z19 .. controls(x19 + 2u, y19) and (x20 - 3u, y20 + 2u) .. z20
-- z21 .. controls(x21 - 3u, y21 - 2u) and (x17 + 2u, y17) .. cycle;
fix_vstem(o + .48(py + px))(glyph_stored.glyph_name 1, glyph_stored.glyph_name 2);
fix_hstem(o + .48(py + px))(glyph_stored.glyph_name 1, glyph_stored.glyph_name 2);
fix_vstem(px)(glyph_stored.glyph_name 1, glyph_stored.glyph_name 2);
fix_vstem(xgap)(glyph_stored.glyph_name 1);
fix_hstem(py)(glyph_stored.glyph_name 1)((y < hh0) or (y >= hh1));
fix_dimens(x2 + rightbear, y15, y0, 0);
just_labels bot(0, 2, 4, 6, 8, 11, 12, 14, 17);
just_labels top(1, 3, 5, 7, 9, 10, 13, 15, 19);
just_labels lft(16, 18);
just_labels rt(20, 21);
standard_exact_hsbw("OE");
endglyph;

```

Construction of the character quoteleft:

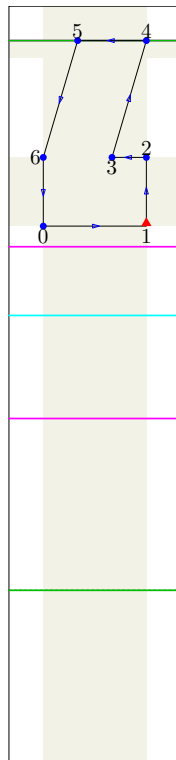

```

encode("quoteleft")(145); standard_introduce("quoteleft");
beginglyph(quoteleft);
 $x_0 = x_6 = \text{leftstemloc}; y_4 = y_5 = \text{uc.height};$ 
 $x_1 - x_0 = x_2 - x_6 = px; x_4 - x_5 = x_3 - x_6 = 2xu; x_4 = x_2;$ 
 $y_2 = y_3; y_6 - y_0 = y_2 - y_1 = py; y_5 - y_6 = y_4 - y_3 = 3xu + 2u;$ 
Fill  $z_0 \text{ -- } z_1 \text{ -- } z_2 \text{ -- } z_3 \text{ -- } z_4 \text{ -- } z_5 \text{ -- } z_6 \text{ -- cycle};$ 
fix_vstem(px)(glyph_stored.glyph_name 1);
fix_hstem(py)(glyph_stored.glyph_name 1);
fix_dimens( $x_1 + \text{rightbear}, y_4, 0, 0$ );
ghost_stem top;

just_labels bot(0, 1, 3);
just_labels top(2, 4, 5);
just_labels lft(6);

standard_exact_hsbw("quoteleft");
endglyph;

```

Construction of the character quoteright:

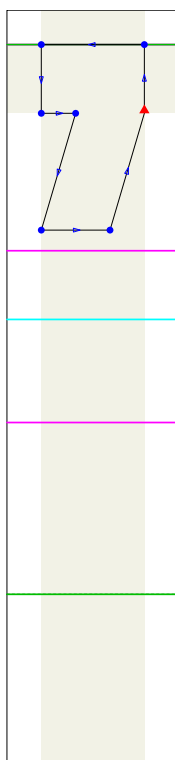

```
encode("quoteright")(146); standard_introduce("quoteright");
beginlyph(quoteright);
use_glyph(quotesinglbase)(0, uc_height - py);
fix_dimens(wd.quotesinglbase, ht.quotesinglebase + uc_height - py, 0, 0);
standard_exact_hsbw("quoteright");
endglyph;
```

Construction of the character `quotedblleft`:

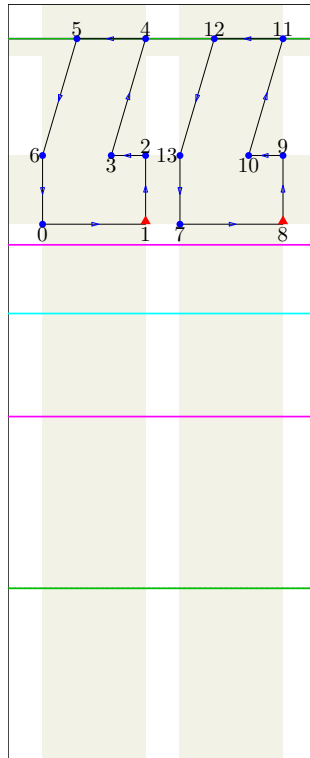

```

encode("quotedblleft")(147); standard_introduce("quotedblleft");
beginglyph(quotedblleft);
 $x_0 = x_6 = \text{leftstemloc}$ ;  $y_4 = y_5 = y_{11} = y_{12} = \text{uc\_height}$ ;  $x_{13} = x_7$ ;
 $x_1 - x_0 = x_2 - x_6 = x_8 - x_7 = x_9 - x_{13} = px$ ;  $x_4 - x_5 = x_3 - x_6 = x_{11} - x_{12} = x_{10} - x_{13} = 2xu$ ;
 $x_{13} - x_2 = xu$ ;  $y_2 = y_3$ ;  $y_9 = y_{10}$ ;  $x_4 = x_2$ ;  $x_{11} = x_9$ ;
 $y_6 - y_0 = y_2 - y_1 = y_{13} - y_7 = y_9 - y_8 = py$ ;
 $y_5 - y_6 = y_4 - y_3 = y_{12} - y_{13} = y_{11} - y_{10} = 3xu + 2u$ ;

Fill  $z_0 \text{ -- } z_1 \text{ -- } z_2 \text{ -- } z_3 \text{ -- } z_4 \text{ -- } z_5 \text{ -- } z_6 \text{ -- cycle}$ ,
       $z_7 \text{ -- } z_8 \text{ -- } z_9 \text{ -- } z_{10} \text{ -- } z_{11} \text{ -- } z_{12} \text{ -- } z_{13} \text{ -- cycle}$ ;

fix_vstem( $px$ )(glyph_stored.glyph_name 1, glyph_stored.glyph_name 2);
fix_hstem( $py$ )(glyph_stored.glyph_name 1, glyph_stored.glyph_name 2);
fix_dimens( $x_8 + \text{rightbear}$ ,  $y_{11}$ , 0, 0);
ghost_stem top;

just_labels bot(0, 1, 3, 7, 8, 10);
just_labels top(2, 4, 5, 9, 11, 12);
just_labels lft(6, 13);

standard_exact_hsbw("quotedblleft");
endglyph;

```

Construction of the character `quotedbright`:

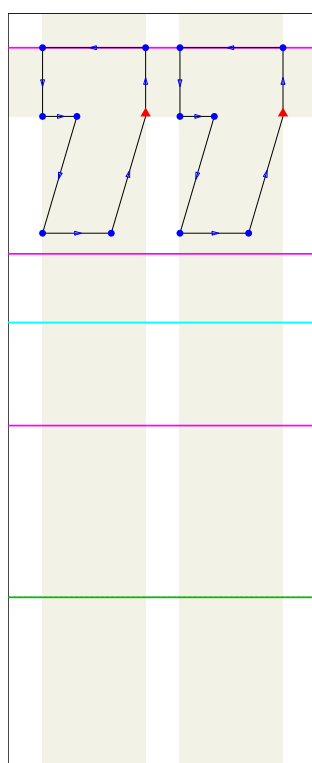

```
encode("quotedbright")(148); standard_introduce("quotedbright");  
begin_glyph(quotedbright);  
use_glyph(quotedblbase)(0, uc_height - py);  
fix_dimens(wd.quotedblbase, wd.quotedblbase + uc_height - py, 0, 0);  
standard_exact_hsbw("quotedbright");  
end_glyph;
```

Construction of the character bullet:

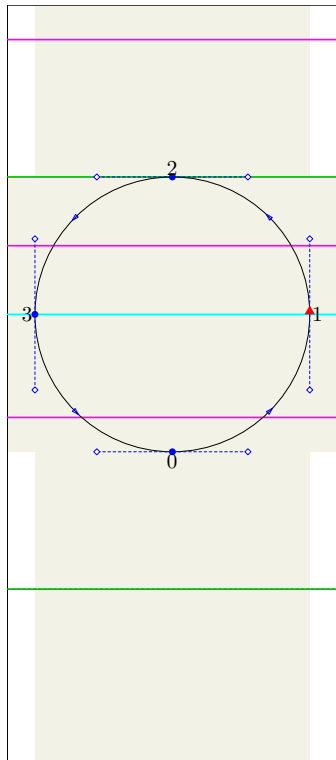

```

encode("bullet")(149); standard_introduce("bullet");
begin_glyph(bullet);
 $x_3 = \text{leftstemloc} - o;$ 
 $y_2 - y_0 = x_1 - x_3 = .5uc\_height;$   $y_1 = y_3 = .5uc\_height;$   $x_0 = x_2;$ 
 $.5[z_3, z_1] = .5[z_0, z_2];$ 

Fill  $z_0 \dots z_1 \dots z_2 \dots z_3 \dots$  cycle;

fix_vstem(.5uc_height)(glyph_stored.glyph_name 1);
fix_hstem(.5uc_height)(glyph_stored.glyph_name 1);
fix_dimens( $x_1 + \text{rightbear}$ ,  $y_2$ , 0, 0);

just_labels bot(0);
just_labels top(2);
just_labels rt(1);
just_labels lft(3);

standard_exact_hsbw("bullet");
end_glyph;

```

Construction of the character endash:

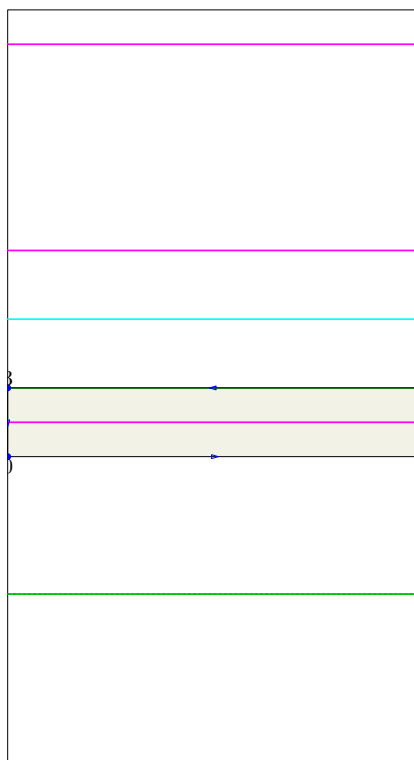

```

encode("endash")(150); standard_introduce("endash");
begin_glyph(endash);
 $x_0 = x_3 = 0;$ 
 $.5[y_0, y_3] = .5[y_1, y_2] = .5lc\_height;$   $y_3 - y_0 = y_2 - y_1 = py;$ 
 $x_2 - x_3 = x_1 - x_0 = wd.n;$ 

Fill  $z_0$  --  $z_1$  --  $z_2$  --  $z_3$  -- cycle;

fix_hstem(py)(glyph_stored.glyph_name 1);
fix_dimens( $x_1, y_2, 0, 0$ );

just_labels bot(0, 1);
just_labels top(2, 3);
standard_exact_hsbw("endash");
end_glyph;

```

Construction of the character emdash:

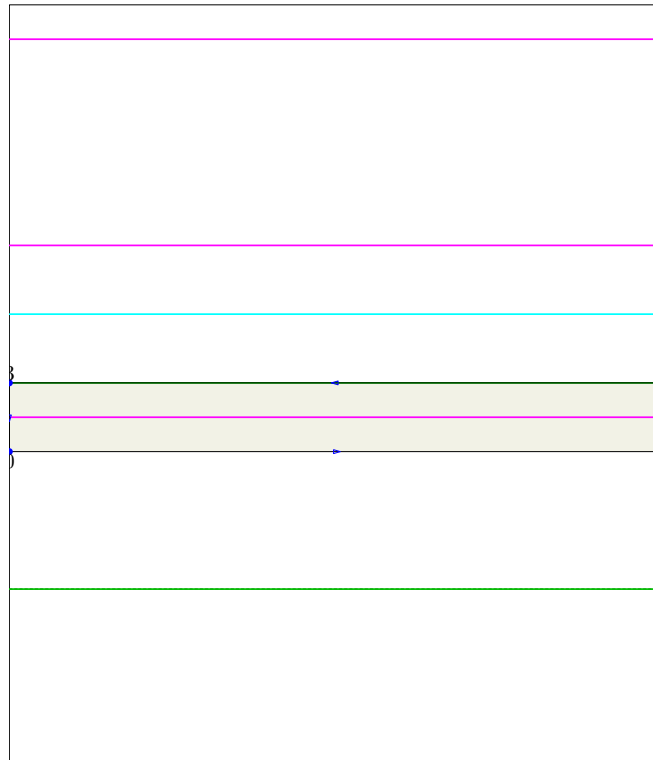

```

encode("emdash")(151); standard_introduce("emdash");
begin_glyph(emdash);
 $x_0 = x_3 = 0;$ 
 $.5[y_0, y_3] = .5[y_1, y_2] = .5lc\_height;$   $y_3 - y_0 = y_2 - y_1 = py;$ 
 $x_2 - x_3 = x_1 - x_0 = wd.m;$ 

Fill  $z_0 -- z_1 -- z_2 -- z_3 -- cycle;$ 

fix_hstem( $py$ )(glyph_stored.emdash 1);
fix_dimens( $x_1, y_2, 0, 0$ );

just_labels bot(0, 1);
just_labels top(2, 3);
standard_exact_hsbw("emdash");
end_glyph;

```

Construction of the character tilde:

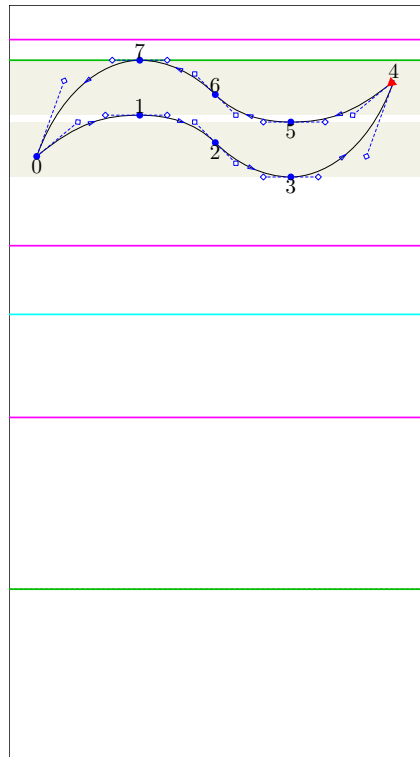

```

encode("tilde")(152); standard_introduce("tilde");
begin_glyph(tilde);
 $x_0 = \text{leftstemloc} - o;$ 
 $x_7 - x_0 = x_1 - x_0 = x_4 - x_3 = x_4 - x_5 = 3xu;$   $x_6 - x_7 = x_3 - x_2 = 2xu + u;$   $x_6 = x_2;$ 
 $y_1 = y_5 + u;$   $y_7 - y_1 = y_5 - y_3 = xu + 3u;$   $y_1 - y_0 = y_4 - y_5 = xu + u;$ 
 $y_1 - y_2 = y_6 - y_5 = xu - u;$ 
 $y_3 = \text{lc.height} + 2xu;$ 

Fill  $z_0$  .. controls( $x_0 + xu + u, y_0 + xu$ ) and ( $x_1 - xu, y_1$ )
  ..  $z_1$  .. controls( $x_1 + xu - u, y_1$ ) and ( $x_2 - 3u, y_2 + 3u$ )
  ..  $z_2$  .. controls( $x_2 + 3u, y_2 - 3u$ ) and ( $x_3 - xu + u, y_3$ )
  ..  $z_3$  .. controls( $x_3 + xu - u, y_3$ ) and ( $x_4 - xu + u, y_4 - 2xu - u$ )
  ..  $z_4$  .. controls( $x_4 - xu - u, y_4 - xu$ ) and ( $x_5 + xu, y_5$ )
  ..  $z_5$  .. controls( $x_5 - xu + u, y_5$ ) and ( $x_6 + 3u, y_6 - 3u$ )
  ..  $z_6$  .. controls( $x_6 - 3u, y_6 + 3u$ ) and ( $x_7 + xu - u, y_7$ )
  ..  $z_7$  .. controls( $x_7 - xu + u, y_7$ ) and ( $x_0 + xu - u, y_0 + 2xu + u$ ) .. cycle;

fix_hstem( $y_7 - y_1$ )(glyph_stored.glyph_name 1);
fix_dimens( $x_4 + \text{rightbear}, y_7, 0, 0$ );

just_labels bot(0, 2, 3, 5);
just_labels top(1, 4, 6, 7);

standard_exact_hsbw("tilde");
end_glyph;

```

Construction of the character trademark:

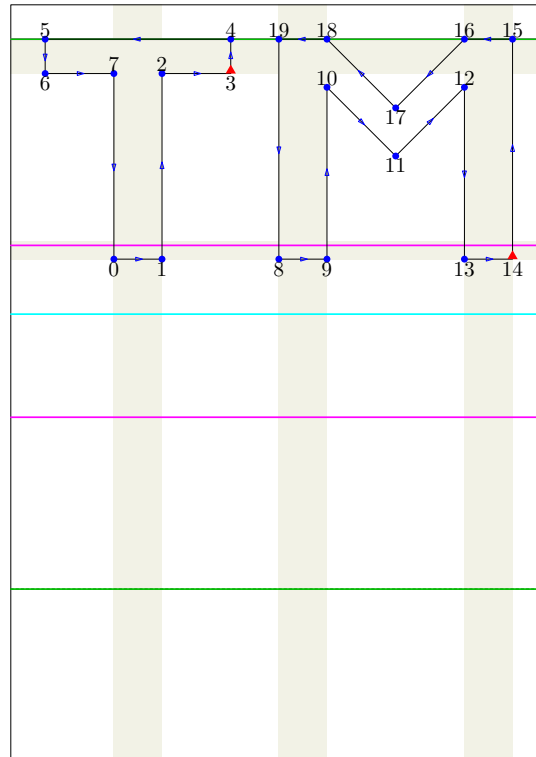

```

encode("trademark")(153); standard_introduce("trademark");
beginglyph(trademark);
 $y_0 = y_1 = y_8 = y_9 = y_{13} = y_{14} = lc\_height - 2u$ ;  $x_5 = x_6 = leftstemloc$ ;
 $y_4 = y_5 = y_{15} = y_{16} = y_{18} = y_{19} = uc\_height$ ;
 $x_2 - x_7 = x_1 - x_0 = x_9 - x_8 = x_{18} - x_{19} = x_{10} - x_{19}$ 
 $= x_{15} - x_{16} = x_{15} - x_{12} = x_{14} - x_{13} = .5(px - u)$ ;
 $x_7 - x_6 = x_3 - x_2 = 2xu$ ;  $x_7 = x_0$ ;  $x_{19} - x_4 = x_8 - x_3 = xu + 2u$ ;  $x_4 = x_3$ ;
 $x_{17} - x_{18} = x_{12} - x_{11} = 2xu = y_{18} - y_{17} = y_{12} - y_{11}$ ;  $x_{11} = x_{17}$ ;  $x_{12} = x_{13}$ ;
 $y_5 - y_6 = y_5 - y_7 = y_4 - y_2 = y_4 - y_3 = .5py$ ;  $y_{18} - y_{10} = y_{16} - y_{12} = .7py$ ;

Fill  $z_0$  --  $z_1$  --  $z_2$  --  $z_3$  --  $z_4$  --  $z_5$  --  $z_6$  --  $z_7$  -- cycle,
 $z_8$  --  $z_9$  --  $z_{10}$  --  $z_{11}$  --  $z_{12}$  --  $z_{13}$  --  $z_{14}$  --  $z_{15}$  --  $z_{16}$  --  $z_{17}$  --  $z_{18}$  --  $z_{19}$  -- cycle;

fix_vstem(.5(px - u))(glyph_stored.glyph_name 1);
fix_vstem(.5(px - u))(glyph_stored.glyph_name 2);
fix_hstem(.5(py))(glyph_stored.glyph_name 1);
ghost_stem bot;
fix_dimens( $x_{14} + rightbear$ ,  $y_{15}$ , 0, 0);

just_labels bot(0, 1, 3, 6, 8, 9, 11, 13, 14, 17);
just_labels top(2, 4, 5, 7, 10, 12, 15, 16, 18, 19);

standard_exact_hsbw("trademark");
endglyph;

```

Construction of the character scaron:

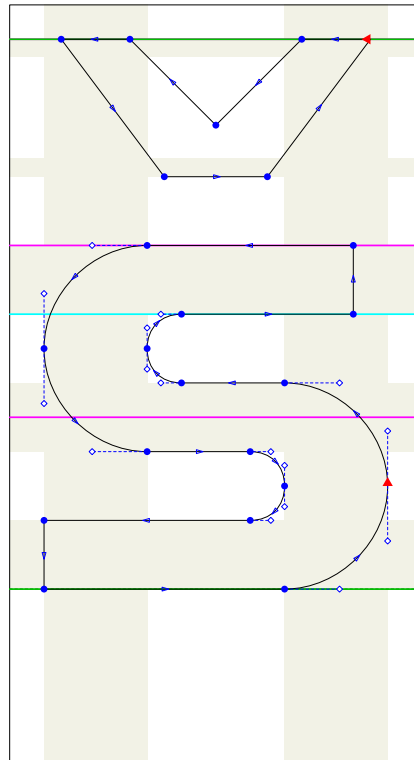

```

encode("scaron")(154); standard_introduce("scaron");
beginlyph(scaron);
use_accent(s, caron);

fix_dimens(wd.s, ht.caron, 0, 0);
standard_exact_hsbw("scaron");
endglyph;

```

Construction of the character `guilsingright`:

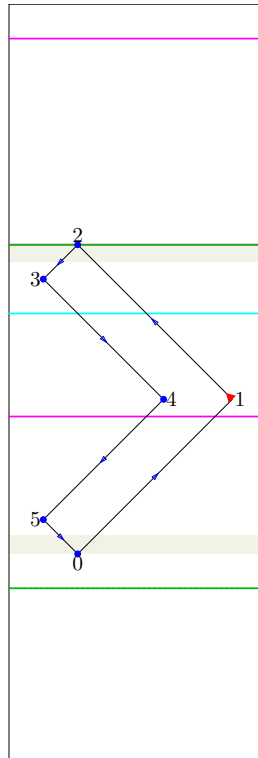

```

encode("guilsingright")(155); standard_introduce("guilsingright");
begin_glyph(guilsingright);
 $y_0 = xu; x_3 = x_5 = \text{leftstemloc}; y_2 = \text{lc\_height};$ 
 $x_1 - x_4 = 2xu; y_4 = y_1 = .5[y_0, y_2];$ 
 $x_1 - x_0 = y_1 - y_0;$ 
 $z_0 = z_5 + (xu, -xu); z_3 = z_2 - (xu, xu);$ 
Fill  $z_0$  --  $z_1$  --  $z_2$  --  $z_3$  --  $z_4$  --  $z_5$  -- cycle;
ghost_stem top, bot;
fix_dimens( $x_1 + \text{rightbear}$ ,  $y_2$ , 0, 0);
just_labels bot(0);
just_labels top(2);
just_labels rt(1, 4);
just_labels lft(3, 5);
standard_exact_hsbw("guilsingright");
end_glyph;

```

Construction of the character oe:

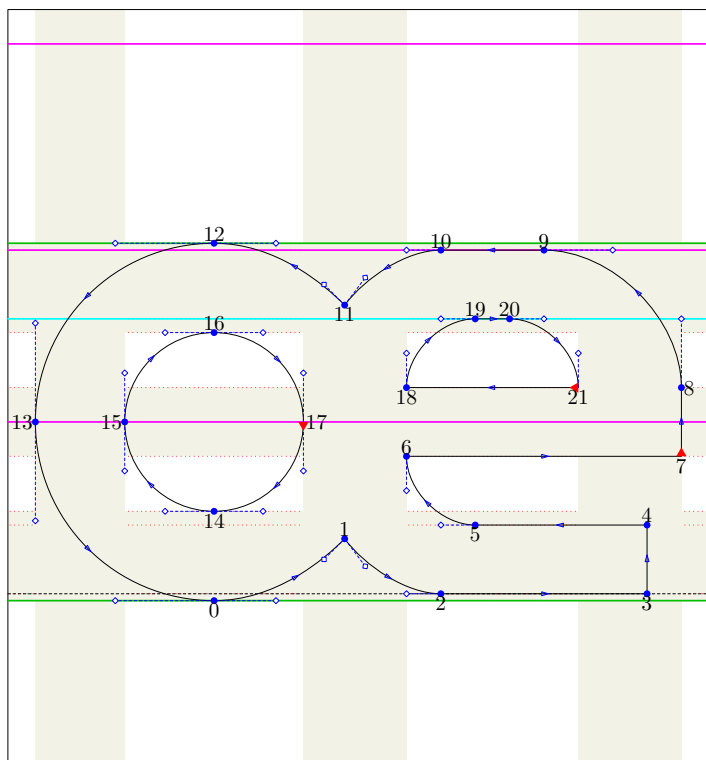

```

encode("oe")(156); standard_introduce("oe");
beginlyph(oe);
 $y_0 = -o; y_2 = y_3 = 0; x_{13} = \text{leftstemloc} - o; y_{12} = \text{lc\_height} + o; y_9 = y_{10} = \text{lc\_height};$ 
 $y_{12} - y_{16} = y_{14} - y_0 = x_{15} - x_{13} = o + .48(py + px); x_{11} - x_{17} = x_1 - x_{17} = xu + u; x_2 - x_{17} = x_{10} - x_{17} = \text{obow};$ 
 $x_{17} - x_{15} = y_{16} - y_{14}; x_{12} = x_{16} = x_{14} = x_0 = .5[x_{15}, x_{17}]; y_{13} = y_{15} = y_{17} = .5[y_0, y_{12}];$ 
 $x_6 - x_{17} = x_{18} - x_{17} = x_8 - x_{21} = px; x_7 = x_8; x_3 = x_4; x_7 - x_4 = xu; x_{20} = x_{19} + xu;$ 
 $y_{10} - y_{19} = y_9 - y_{20} = y_5 - y_2 = y_4 - y_3 = py; y_7 = y_6; y_{10} - y_{11} = y_1 - y_2 = xu + 3u;$ 
 $z_6 = z_5 + (-\text{ibow}, \text{ibow}); z_9 = z_8 + (-\text{obow}, \text{obow}); z_{19} = z_{18} + (\text{ibow}, \text{ibow});$ 
 $z_{21} = z_{20} + (\text{ibow}, -\text{ibow}); hh_0 := y_4; hh_1 := y_6; hh_2 := y_{18}; hh_3 := y_{19};$ 
Fill  $z_0 \dots \text{controls}(x_0 + 2xu - u, y_0)$  and  $(x_1 - 3u, y_1 - 3u) \dots z_1$ 
  ..  $\text{controls}(x_1 + 3u, y_1 - xu + u)$  and  $(x_2 - xu, y_2) \dots z_2$  --  $z_3$  --  $z_4$ 
  -- bow left(5, 6) --  $z_7$  -- crest up(8, 9) --  $z_{10} \dots \text{controls}(x_{10} - xu, y_{10})$ 
  and  $(x_{11} + 3u, y_{11} + xu - u) \dots z_{11}$  ..  $\text{controls}(x_{11} - 3u, y_{11} + 3u)$ 
  and  $(x_{12} + 2xu - u, y_{12}) \dots z_{12}$  ..  $z_{13}$  .. cycle;
unFill  $z_{14} \dots z_{15} \dots z_{16} \dots z_{17}$  .. cycle, bow up(18, 19) -- bow right(20, 21) -- cycle;

fix_hstem( $o + .48(py + px)$ )(glyph_stored.glyph_name 1, glyph_stored.glyph_name 2);
fix_vstem( $o + .48(py + px)$ )(glyph_stored.glyph_name 1, glyph_stored.glyph_name 2);
fix_vstem( $px$ )(glyph_stored.glyph_name 1, glyph_stored.glyph_name 2,
  glyph_stored.glyph_name 3);
fix_hstem( $py$ )(glyph_stored.glyph_name 1,
  glyph_stored.glyph_name 3)(( $y \leq hh_0$ ) or ( $y \geq hh_3$ ));
fix_hstem( $py$ )(glyph_stored.glyph_name 1,
  glyph_stored.glyph_name 3)(( $y \geq hh_1$ ) and ( $y \leq hh_2$ ));
fix_dimens( $\text{round}(x_7 + \text{rightbear}), y_{12}, y_0, 0$ );

just_labels bot(0, 2, 3, 5, 7, 11, 14, 18, 21);
just_labels top(1, 4, 6, 9, 10, 12, 16, 19, 20);
just_labels lft(13, 15); just_labels rt(8, 17);

standard_exact_hsbw("oe");
endglyph;

```

Construction of the character dieresis:

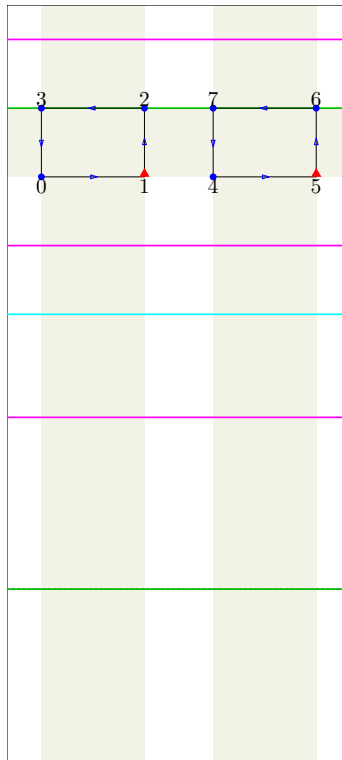

```

encode("dieresis")(168); standard_introduce("dieresis");
begin_glyph(dieresis);
 $x_3 = x_0 = \text{leftstemloc}$ ;
 $x_2 - x_3 = x_1 - x_0 = x_6 - x_7 = x_5 - x_4 = px$ ;
 $x_7 - x_2 = x_4 - x_1 = 2xu$ ; %5xu;
 $y_0 = y_1 = y_4 = y_5 = lc\_height + 2xu$ ;
 $y_3 - y_0 = y_2 - y_1 = y_7 - y_4 = y_6 - y_5 = py$ ;

Fill  $z_0$  --  $z_1$  --  $z_2$  --  $z_3$  -- cycle,  $z_4$  --  $z_5$  --  $z_6$  --  $z_7$  -- cycle;

fix_vstem( $px$ )(glyph_stored.glyph_name 1, glyph_stored.glyph_name 2);
fix_hstem( $py$ )(glyph_stored.glyph_name 1, glyph_stored.glyph_name 2);
fix_dimens( $x_5 + \text{rightbear}$ ,  $y_6$ , 0, 0);

just_labels bot(0, 1, 4, 5);
just_labels top(2, 3, 6, 7);

standard_exact_hsbw("dieresis");
end_glyph;

```

Construction of the character Ydieresis:

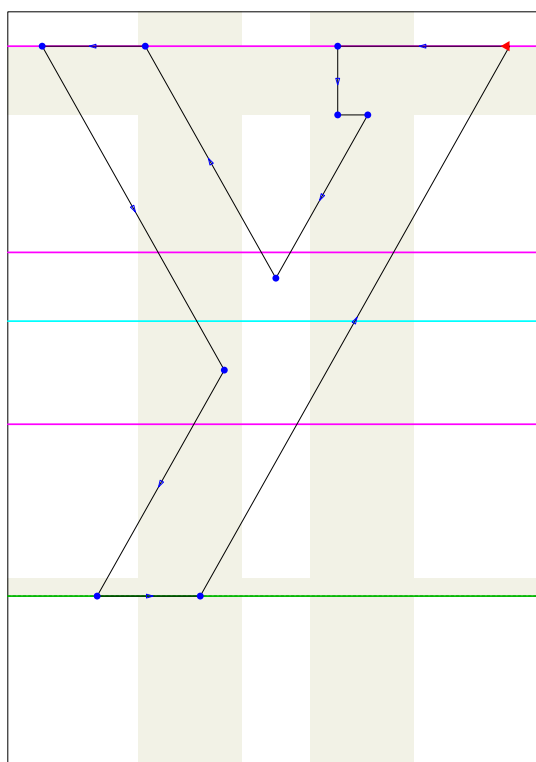

```

encode("Ydieresis")(159); standard_introduce("Ydieresis");
begin_glyph(Ydieresis);
use_accent(Y, dieresis);

fix_dimens(wd.Y, ht.Y + ht.dieresis - lc.height, 0, 0);

standard_exact_hsbw("Ydieresis");
end_glyph;

```

Construction of the character exclamdown:

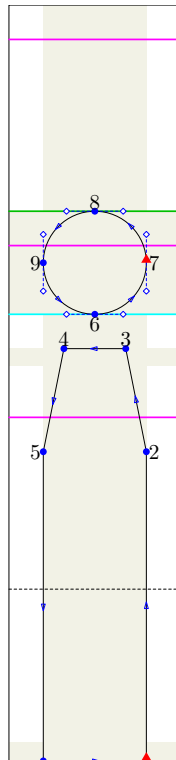

```

encode("exclamdown")(161); standard_introduce("exclamdown");
begin_glyph(exclamdown);
 $x_0 = x_5 = \text{leftstemloc}$ ;
 $x_1 - x_0 = x_2 - x_5 = px = x_7 - x_9 = y_8 - y_6$ ;  $x_4 - x_5 = x_2 - x_3 = 3u$ ;
 $x_8 = x_6 = .5[x_9, x_7] = .5[x_5, x_2]$ ;
 $y_0 = y_1 = \text{descender}$ ;  $y_8 - y_0 = \text{uc\_height}$ ;  $y_8 - y_5 = y_8 - y_2 = .5\text{uc\_height} - .5py$ ;
 $y_6 - y_4 = y_6 - y_3 = xu$ ;  $y_9 = y_7 = .5[y_6, y_8]$ ;

Fill  $z_0 \text{ -- } z_1 \text{ -- } z_2 \text{ -- } z_3 \text{ -- } z_4 \text{ -- } z_5 \text{ -- cycle}$ ,  $z_6 \dots z_7 \dots z_8 \dots z_9 \dots \text{cycle}$ ;

fix_vstem( $px$ )(glyph_stored.glyph_name 1, glyph_stored.glyph_name 2);
fix_hstem( $px$ )(glyph_stored.glyph_name 2);
ghost_stem bot, top( $y_4$ );
fix_dimens( $x_1 + \text{rightbear}$ ,  $y_8$ ,  $y_0$ , 0);

just_labels bot(0, 1, 6);
just_labels top(3, 4, 8);
just_labels rt(2, 7);
just_labels lt(5, 9);

standard_exact_hsbw("exclamdown");
end_glyph;

```

Construction of the character cent:

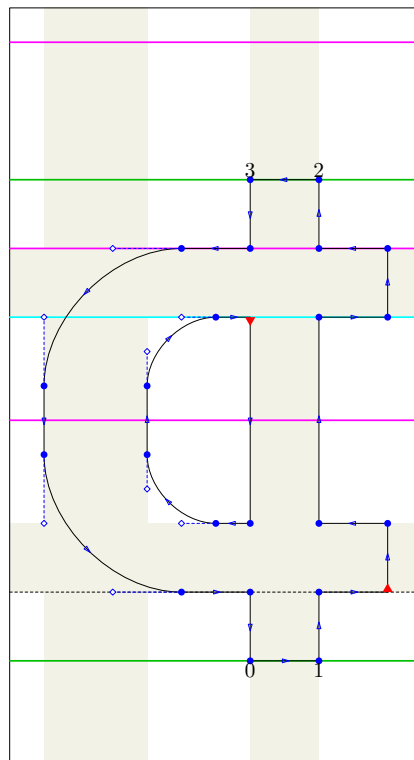

```

encode("cent")(162); standard_introduce("cent");
beginglyph(cent);
 $y_0 = y_1 = -2xu$ ;  $y_2 = y_3 = lc\_height + 2xu$ ;
 $x_2 - x_3 = x_1 - x_0 = 2xu$ ;  $x_2 = x_1 = wd.c - rightbear - 2xu$ ;

find_outlines(glyph_stored.c 1, z_0 -- z_1 -- z_2 -- z_3 -- cycle)(glyph);

Fill glyph1;
unFill glyph2;

use_stems(c);
fix_vstem(2xu)(glyph_stored.glyph_name 1,
  glyph_stored.glyph_name 2)(x < wd.c - rightbear);
fix_dimens(wd.c, y_2, y_1, 0);

just_labels bot(0, 1);
just_labels top(2, 3);

standard_exact_hsbw("cent");
endglyph;

```

Construction of the character sterling:

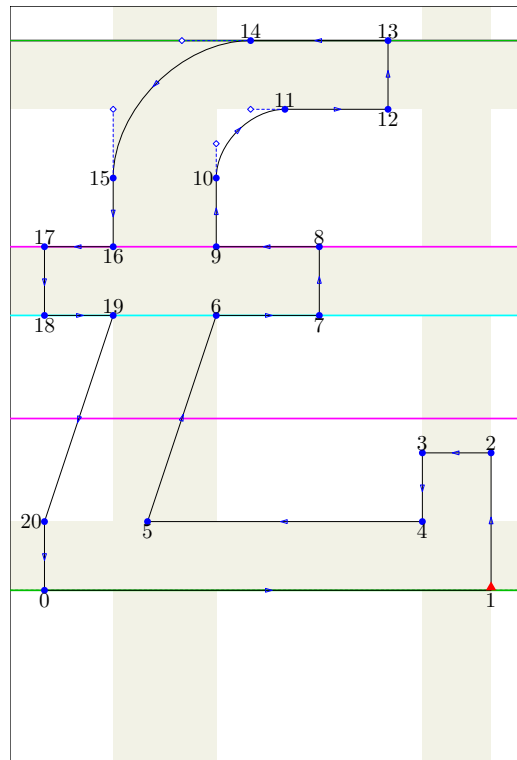

```

encode("sterling")(163); standard_introduce("sterling");
beginglyph(sterling);
y0 = y1 = 0; x0 = x17 = x18 = x20 = leftstemloc; y13 = y14 = uc_height;
x5 - x20 = x6 - x19 = x9 - x16 = x10 - x15 = px; x2 - x3 = x1 - x4 = xgap;
x16 - x17 = x19 - x18 = 2xu; x8 - x9 = x7 - x6 = 3xu; x15 = x16; x12 - x11 = 3xu; x13 = x12;
x4 - x5 = 8xu; x3 = x4;
y20 - y0 = y5 - y0 = y4 - y1 = y17 - y18 = y16 - y19
= y9 - y6 = y8 - y7 = y14 - y11 = y13 - y12 = py; y3 - y4 = 2xu; y2 = y3; y8 = y9 = y16 = y17 = lc_height;
z11 = z10 + (ibow, ibow); z15 = z14 - (obow, obow);
hv0 := x7; hh0 := y3;

Fill z0 -- z1 -- z2 -- z3 -- z4 -- z5 -- z6 -- z7 -- z8 -- z9 -- bow up(10, 11) -- z12 -- z13
-- crest left(14, 15) -- z16 -- z17 -- z18 -- z19 -- z20 -- cycle;

fix_vstem(px)(glyph_stored.glyph_name 1)(x < hv0);
fix_vstem(2xu)(glyph_stored.glyph_name 1)(x > hv0);
fix_hstem(py)(glyph_stored.glyph_name 1)(y <> hh0);
fix_dimens(x1 + rightbear, y13, 0, 0);

just_labels bot(0, 1, 4, 5, 7, 9, 12, 16, 18);
just_labels top(2, 3, 6, 8, 11, 13, 14, 17, 19);
just_labels lft(10, 15, 20);

standard_exact_hsbw("sterling");
endglyph;

```

Construction of the character currency:

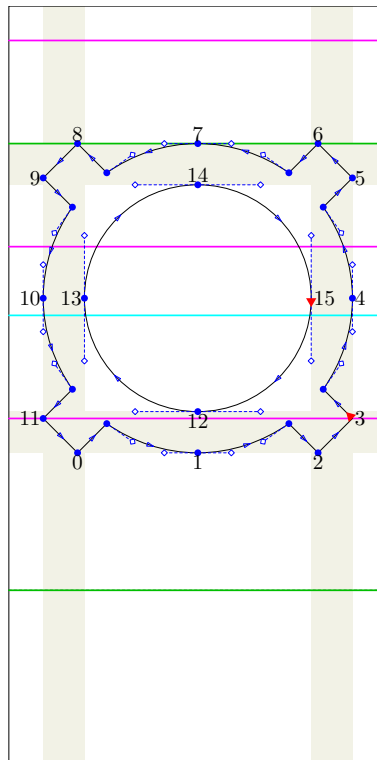

```

encode("currency")(164); standard_introduce("currency");
beginlyph(currency);
 $y_0 = y_1 = y_2 = 4xu$ ;  $x_9 = x_{10} = x_{11} = \textit{leftstemloc}$ ;  $y_6 = y_7 = y_8 = \textit{ascender} - 4xu$ ;
 $x_5 - x_9 = x_4 - x_{10} = x_3 - x_{11} = y_7 - y_1$ ;
 $x_{13} - x_{10} = x_4 - x_{15} = y_{12} - y_1 = y_7 - y_{14} = xu + u$ ;
 $y_{10} = y_{13} = y_{15} = y_4 = .5[y_1, y_7]$ ;  $x_1 = x_{12} = x_{14} = x_7 = .5[x_{10}, x_4]$ ;
 $x_0 - x_{11} = y_{11} - y_0 = x_3 - x_2 = y_3 - y_2 = x_5 - x_6$ 
 $= y_6 - y_5 = x_8 - x_9 = y_8 - y_9 = xu$ ;

find_outlines( $z_0$  --  $z_5$  --  $z_6$  --  $z_{11}$  -- cycle,  $z_2$  --  $z_3$  --  $z_8$  --  $z_9$  -- cycle)(glypha);
find_outlines(glypha1,  $z_1$  ..  $z_4$  ..  $z_7$  ..  $z_{10}$  .. cycle)(glyphb);

Fill glyphb1;
unFill  $z_{12}$  ..  $z_{13}$  ..  $z_{14}$  ..  $z_{15}$  .. cycle;

fix_vstem( $xu + u$ )(glyph_stored.glyph_name 1, glyph_stored.glyph_name 2);
fix_hstem( $xu + u$ )(glyph_stored.glyph_name 1, glyph_stored.glyph_name 2);
fix_dimens( $x_3 + \textit{rightbear}$ ,  $y_6$ , 0, 0);

just_labels bot(0, 1, 2, 12);
just_labels top(6, 7, 8, 14);
just_labels rt(3, 4, 5, 15);
just_labels lft(9, 10, 11, 13);

standard_exact_hsbw("currency");
endglyph;

```

Construction of the character yen:

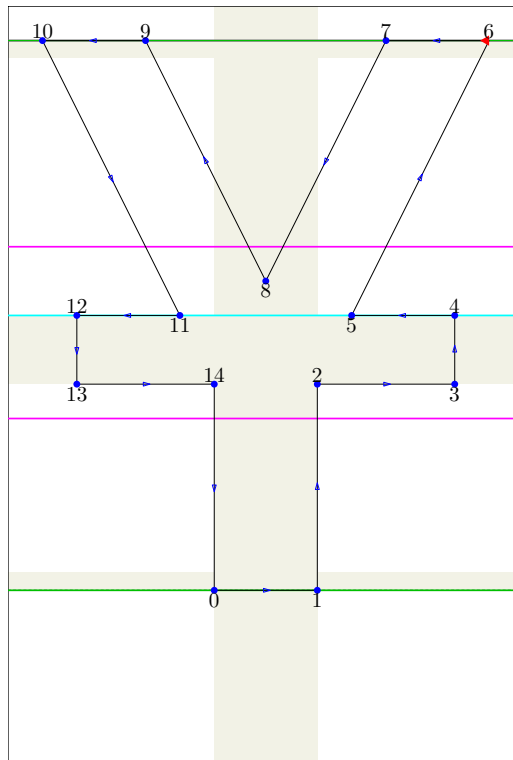

```

encode("yen")(165); standard_introduce("yen");
begin_glyph(yen);
y0 = y1 = 0; x10 = leftstemloc; y6 = y7 = y9 = y10 = uc_height;
x1 - x0 = x2 - x14 = x9 - x10 = x6 - x7 = px; x14 - x10 = x6 - x2 = 5xu;
x0 = x14; x14 - x13 = x3 - x2 = 4xu; x12 = x13; x4 = x3;
y12 - y13 = y11 - y14 = y5 - y2 = y4 - y3 = py; y12 = y11 = y4 = y5 = .5uc_height;
z11 = whatever[z14, z10]; z5 = whatever[z2, z6];
z8 = whatever[z14, z7] = whatever[z2, z9];

Fill z0 -- z1 -- z2 -- z3 -- z4 -- z5 -- z6 -- z7 -- z8 -- z9 -- z10 -- z11 -- z12 -- z13 -- z14 -- cycle;

fix_vstem(px)(glyph_stored.glyph_name 1);
fix_hstem(py)(glyph_stored.glyph_name 1);
fix_dimens(x6 + rightbear, y6, 0, 0);
ghost_stem bot, top;

just_labels bot(0, 1, 3, 5, 8, 11, 13);
just_labels top(2, 4, 6, 7, 9, 10, 12, 14);

standard_exact_hsbw("yen");
end_glyph;

```

Construction of the character brokenbar:

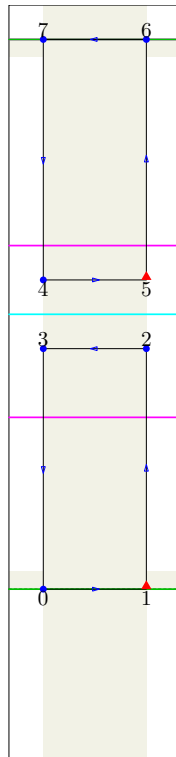

```

encode("brokenbar")(166); standard_introduce("brokenbar");
beginglyph(brokenbar);
 $y_0 = y_1 = 0$ ;  $x_0 = x_3 = x_4 = x_7 = \textit{leftstemloc}$ ;  $y_6 = y_7 = \textit{uc\_height}$ ;
 $x_2 - x_3 = x_1 - x_0 = x_5 - x_4 = x_6 - x_7 = \textit{px}$ ;
 $.5[y_2, y_5] = .5[y_3, y_4] = .5\textit{uc\_height}$ ;  $y_4 - y_3 = y_5 - y_2 = \textit{py}$ ;
Fill  $z_0$  --  $z_1$  --  $z_2$  --  $z_3$  -- cycle,  $z_4$  --  $z_5$  --  $z_6$  --  $z_7$  -- cycle;
fix_vstem( $\textit{px}$ )(glyph_stored.glyph_name 1, glyph_stored.glyph_name 2);
ghost_stem top, bot;
fix_dimens( $x_1 + \textit{rightbear}$ ,  $y_6$ , 0, 0);
just_labels bot(0, 1, 4, 5);
just_labels top(2, 3, 6, 7);
standard_exact_hsbw("brokenbar");
endglyph;

```

Construction of the character section:

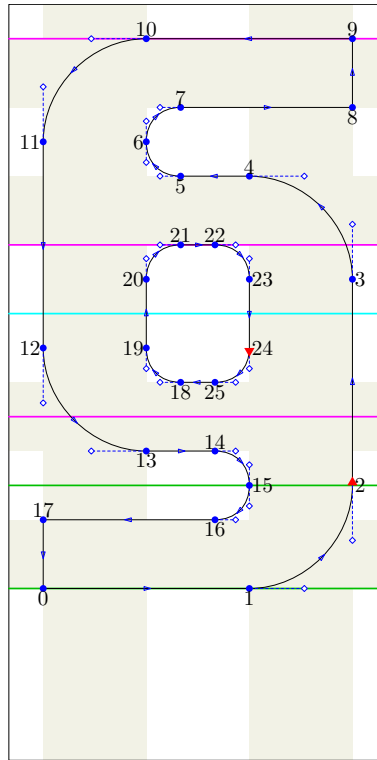

```

encode("section")(167); standard_introduce("section");
beginglyph(section);
 $y_0 = y_1 = 0; x_0 = x_{11} = x_{12} = x_{17} = leftstemloc; y_9 = y_{10} = uc.height;$ 
 $x_{19} - x_{12} = x_6 - x_{11} = x_3 - x_{23} = x_2 - x_{15} = px; x_{20} = x_{19}; x_{23} = x_{24};$ 
 $x_{22} - x_{21} = x_{25} - x_{18} = xu; x_9 = x_8 = x_3 = x_2;$ 
 $y_{17} - y_0 = y_{16} - y_1 = y_{25} - y_{14} = y_{18} - y_{13}$ 
 $= y_4 - y_{22} = y_5 - y_{21} = y_9 - y_8 = y_{10} - y_7 = py; y_{13} = y_{14}; y_4 = y_5;$ 
 $z_2 = z_1 + (.75obow, .75obow); z_4 = z_3 + (-.75obow, .75obow); z_6 = z_5 + (-.5ibow, .5ibow);$ 
 $z_7 = z_6 + (.5ibow, .5ibow); z_{11} = z_{10} - (.75obow, .75obow); z_{13} = z_{12} + (.75obow, -.75obow);$ 
 $z_{15} = z_{14} + (.5ibow, -.5ibow); z_{16} = z_{15} - (.5ibow, .5ibow);$ 
 $z_{19} = z_{18} + (-.5ibow, .5ibow); z_{21} = z_{20} + (.5ibow, .5ibow);$ 
 $z_{23} = z_{22} + (.5ibow, -.5ibow); z_{25} = z_{24} - (.5ibow, .5ibow);$ 
 $hw_0 := x_{18}; hv_1 := x_{22}; hh_0 := y_{15}; hh_1 := y_6;$ 
Fill  $z_0$  -- small_crescent right(1, 2) -- small_crescent up(3, 4)
  -- small_bow left(5, 6) & small_bow up(6, 7)
  --  $z_8$  --  $z_9$  -- small_crescent left(10, 11) -- small_crescent down(12, 13)
  -- small_bow right(14, 15) & small_bow down(15, 16) --  $z_{17}$  -- cycle;
unFill small_bow left(18, 19) -- small_bow up(20, 21)
  -- small_bow right(22, 23) -- small_bow down(24, 25) -- cycle;

fix_vstem( $px$ )(glyph_stored.glyph_name 1, glyph_stored.glyph_name 2)( $x < hw_0$ );
fix_vstem( $px$ )(glyph_stored.glyph_name 1, glyph_stored.glyph_name 2)( $x > hv_1$ );
fix_hstem( $py$ )(glyph_stored.glyph_name 1)(( $y < hh_0$ ) or ( $y > hh_1$ ));
fix_hstem( $py$ )(glyph_stored.glyph_name 1,
  glyph_stored.glyph_name 2)(( $y > hh_0$ ) and ( $y < hh_1$ ));
fix_dimens( $x_2 + rightbear, y_2, 0, 0$ );

just_labels bot(0, 1, 5, 8, 13, 16, 18, 25);
just_labels top(4, 7, 9, 10, 14, 17, 21, 22);
just_labels rt(2, 3, 15, 23, 24); just_labels lft(6, 11, 12, 19, 20);

standard_exact_hsbw("section");
endglyph;

```

Construction of the character copyright:

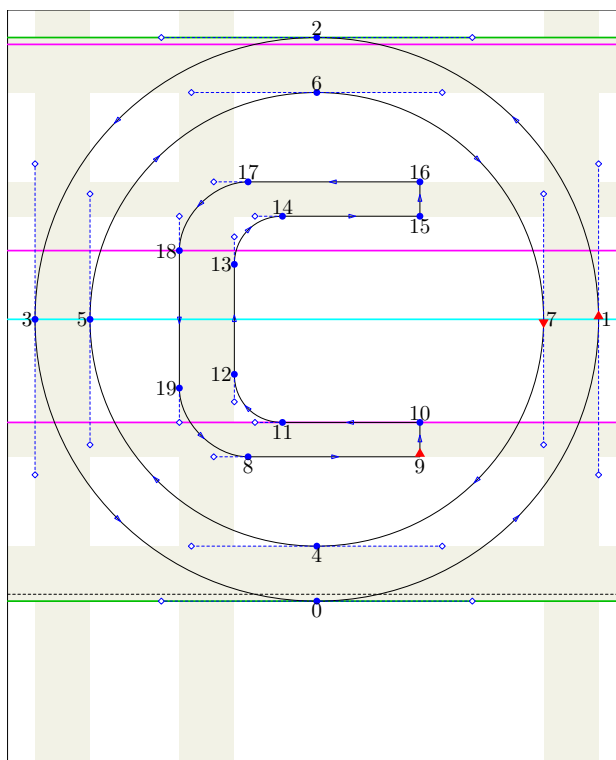

```

encode("copyright")(169); standard_introduce("copyright");
beginglyph (copyright);
 $y_0 = -o$ ;  $x_3 = \text{leftstemloc} - o$ ;  $y_2 = \text{uc\_height} + o$ ;  $x_1 - x_3 = y_2 - y_0$ ;
 $y_4 - y_0 = x_1 - x_7 = y_2 - y_6 = x_5 - x_3 = o + .5(.5(px + u) + .5py + u)$ ;  $y_3 = y_5 = y_7 = y_1 = .5[y_2, y_0]$ ;
 $x_2 = x_6 = x_4 = x_0 = .5[x_1, x_3]$ ;
 $x_{12} - x_{19} = x_{13} - x_{18} = .5(px + u)$ ;  $x_{18} - x_3 = x_{19} - x_3 = 4xu + o$ ;
 $x_1 - x_{16} = x_1 - x_{15} = x_1 - x_{10} = x_1 - x_9 = 5xu + o$ ;
 $y_{10} - y_9 = y_{11} - y_8 = y_{17} - y_{14} = y_{16} - y_{15} = .5py$ ;
 $y_8 - y_0 = y_9 - y_0 = y_2 - y_{17} = y_2 - y_{16} = 4xu + o$ ;
 $z_{12} = z_{11} + (-.7ibow, .7ibow)$ ;  $z_{14} = z_{13} + (.7ibow, .7ibow)$ ;
 $z_{18} = z_{17} - (.5obow, .5obow)$ ;  $z_8 = z_{19} + (.5obow, -.5obow)$ ;

Fill  $z_0 \dots z_1 \dots z_2 \dots z_3 \dots$  cycle;
unFill  $z_4 \dots z_5 \dots z_6 \dots z_7 \dots$  cycle;
Fill  $z_8 \dots z_9 \dots z_{10} \dots$  med_bow left(11, 12) -- med_bow up(13, 14) --  $z_{15} \dots z_{16}$ 
-- med_crescent left(17, 18) -- med_crescent down(19, 8) & cycle;

fix_hstem( $o + .5(.5(px + u) + .5py + u)$ )(glyph_stored.glyph_name 1,
glyph_stored.glyph_name 2);
fix_vstem( $o + .5(.5(px + u) + .5py + u)$ )(glyph_stored.glyph_name 1,
glyph_stored.glyph_name 2);
fix_hstem(.5py)(glyph_stored.glyph_name 3);
fix_vstem(.5(px + u))(glyph_stored.glyph_name 3);
fix_dimens( $x_1 + \text{rightbear} - o, y_2, y_0, 0$ );

just_labels bot(0, 4, 8, 9, 11, 15);
just_labels top(2, 6, 10, 14, 16, 17);
just_labels lft(3, 5, 12, 13, 18, 19);
just_labels rt(1, 7);

standard_exact_hsbw("copyright");
endglyph;

```

Construction of the character ordfeminine:

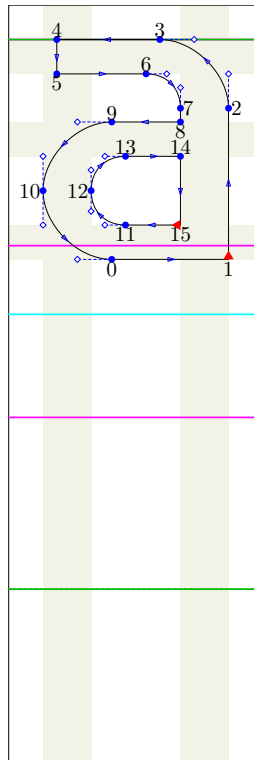

```

encode("ordfeminine")(170); standard_introduce("ordfeminine");
beginlyph(ordfeminine);
y0 = y1 = lc.height - 2u; x10 = leftstemloc; y3 = y4 = uc.height;
x12 - x10 = x2 - x7 = x1 - x15 = .5(px - u); x8 = x7; x2 = x1;
x4 = x5 = x10 + 2u; x14 - x13 = x15 - x11 = xu + 3u;
y11 - y0 = y15 - y1 = y8 - y14
= y9 - y13 = y3 - y6 = y4 - y5 = .5py; y14 = y13;
z3 = z2 + (-.5obow, .5obow); z7 = z6 + (.5ibow, -.5ibow);
z10 = z9 - (.5obow, .5obow); z0 = z10 + (.5obow, -.5obow);
z12 = z11 + (-.5ibow, .5ibow); z13 = z12 + (.5ibow, .5ibow);
hh0 := y11; hh1 := y14; hh2 := y8; hh3 := y6;

Fill z0 -- z1 -- med_crescent up(2, 3) -- z4 -- z5 -- small_bow right(6, 7)
-- z8 -- med_crescent left(9, 10) & med_crescent down(10, 0) & cycle;
unFill small_bow left(11, 12) & small_bow up(12, 13) -- z14 -- z15 -- cycle;

fix_vstem(.5(px - u))(glyph_stored.glyph_name 1, glyph_stored.glyph_name 2);
fix_hstem(.5py)(glyph_stored.glyph_name 1,
  glyph_stored.glyph_name 2)((y <= hh0) or (y >= hh3));
fix_hstem(.5py)(glyph_stored.glyph_name 1,
  glyph_stored.glyph_name 2)((y >= hh1) and (y <= hh2));
fix_dims(x1 + rightbear, y4, 0, 0);

just_labels bot(0, 1, 5, 8, 11, 15);
just_labels top(3, 4, 6, 9, 13, 14);
just_labels rt(2, 7);
just_labels lft(10, 12);
standard_exact_hsbw("ordfeminine");
endglyph;

```

Construction of the character guillemotleft:

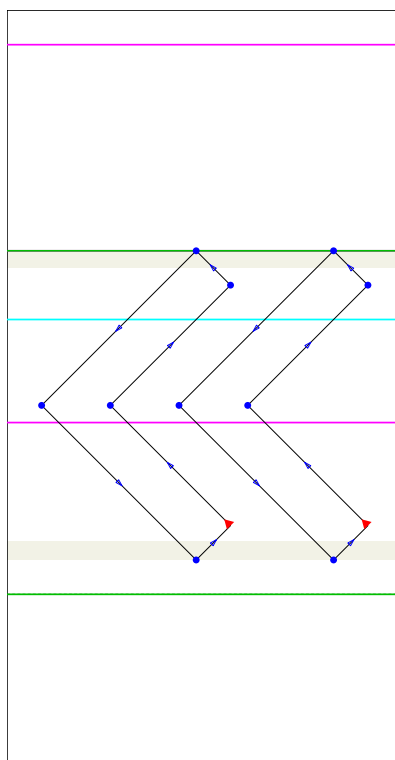

```

encode("guillemotleft")(171); standard_introduce("guillemotleft");
begin_glyph(guillemotleft);
use_glyph(guilsinglleft);
use_glyph(guilsinglleft)(2xu + 2xu);
fix_dimens(wd.guilsinglleft + 2xu + 2xu, ht.guilsinglleft, 0, 0);
standard_exact_hsbw("guillemotleft");
end_glyph;

```

Construction of the character logicalnot:

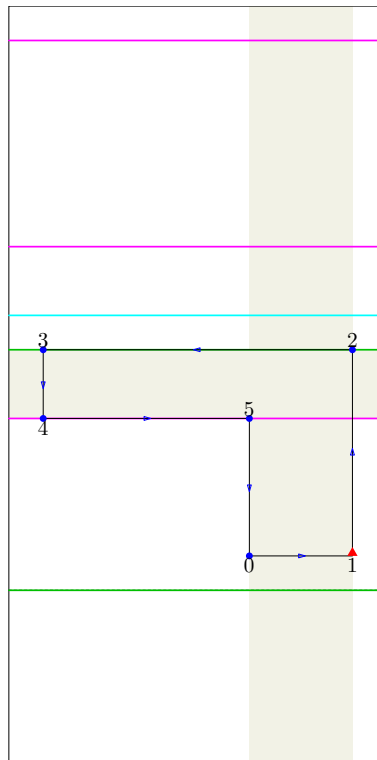

```

encode("logicalnot")(172); standard_introduce("logicalnot");
beginlyph(logicalnot);
 $y_0 = y_1 = xu$ ;  $x_3 = x_4 = \text{leftstemloc}$ ;  $y_2 = y_3 = .5uc\_height - xu$ ;
 $x_5 - x_4 = 6xu$ ;  $x_0 = x_5$ ;  $x_2 - x_5 = x_1 - x_0 = px$ ;
 $y_3 - y_4 = y_2 - y_5 = py$ ;

Fill  $z_0$  --  $z_1$  --  $z_2$  --  $z_3$  --  $z_4$  --  $z_5$  -- cycle;
fix_vstem( $px$ )(glyph_stored.glyph_name 1);
fix_hstem( $py$ )(glyph_stored.glyph_name 1);
fix_dimens( $x_1 + \text{rightbear}$ ,  $y_2$ , 0, 0);

just_labels bot(0, 1, 4);
just_labels top(2, 3, 5);

standard_exact_hsbw("logicalnot");
endglyph;

```

Construction of the character minus:

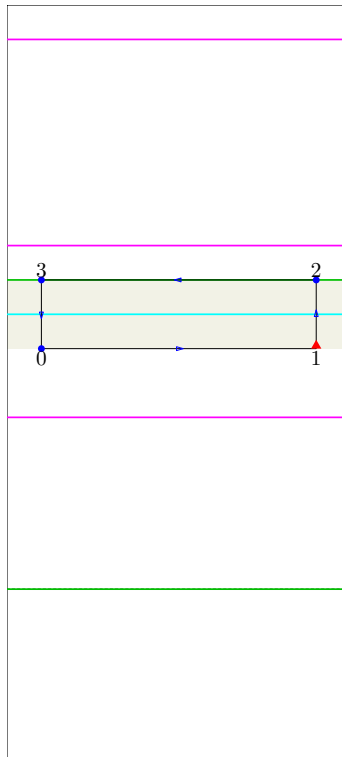

```

encode("minus")(173); standard_introduce("minus");
beginglyph(minus);
 $x_0 = x_3 = \text{leftstemloc}$ ;
 $.5[y_0, y_3] = .5[y_1, y_2] = \text{math\_axis}$ ;  $y_3 - y_0 = y_2 - y_1 = py$ ;
 $x_2 - x_3 = x_1 - x_0 = 2 * 3xu + py$ ; % Length (be equal to plus)

Fill  $z_0$  --  $z_1$  --  $z_2$  --  $z_3$  -- cycle;

fix_hstem(py)(glyph_stored.glyph_name 1);
fix_dimens( $x_1 + \text{rightbear}$ ,  $y_2$ , 0, 0);

just_labels bot(0, 1);
just_labels top(2, 3);
standard_exact_hsbw("minus");
endglyph;

```

Construction of the character registered:

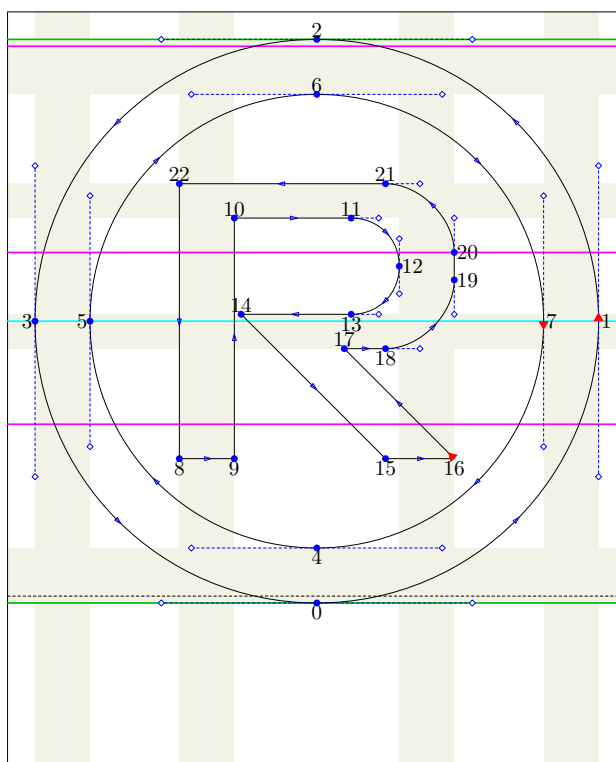

```

encode("registered")(174); standard_introduce("registered");
beginlyph(registered);
 $y_0 = -o$ ;  $x_3 = \text{leftstemloc} - o$ ;  $y_2 = \text{uc\_height} + o$ ;  $x_1 - x_3 = y_2 - y_0$ ;
 $y_4 - y_0 = x_1 - x_7 = y_2 - y_6 = x_5 - x_3 = o + .5(.5(px + u) + .5py + u)$ ;  $y_3 = y_5 = y_7 = y_1 = .5[y_2, y_0]$ ;
 $x_2 = x_6 = x_4 = x_0 = .5[x_1, x_3]$ ;
 $x_9 - x_8 = x_{10} - x_{22} = x_{20} - x_{12} = x_{19} - x_{12} = .5(px + u)$ ;  $x_{14} - x_{10} = u$ ;
 $x_{15} - x_{14} = y_{14} - y_{15}$ ;  $x_{16} - x_{17} = y_{17} - y_{16}$ ;  $x_{16} - x_{15} = 2xu$ ;  $x_{19} = x_{16}$ ;  $x_8 - x_3 = x_{22} - x_3 = 4xu + o$ ;
 $y_8 - y_0 = y_9 - y_0 = y_{15} - y_0 = y_{16} - y_0 = y_2 - y_{22} = y_2 - y_{21} = 4xu + o$ ;  $y_{14} = y_{13}$ ;
 $y_{22} - y_{10} = y_{21} - y_{11} = y_{13} - y_{18} = y_{14} - y_{17} = .5py$ ;
 $z_{12} = z_{11} + (.7ibow, -.7ibow)$ ;  $z_{13} = z_{12} - (.7ibow, .7ibow)$ ;
 $z_{19} = z_{18} + (.5obow, .5obow)$ ;  $z_{21} = z_{20} + (-.5obow, .5obow)$ ;

Fill  $z_0 \dots z_1 \dots z_2 \dots z_3 \dots$  cycle;
unFill  $z_4 \dots z_5 \dots z_6 \dots z_7 \dots$  cycle;
Fill  $z_8 \dots z_9 \dots z_{10} \dots$  med_bow right(11, 12) & med_bow down(12, 13)  $\dots z_{14}$ 
   $\dots z_{15} \dots z_{16} \dots z_{17} \dots$  med_crescent right(18, 19)  $\dots$  med_crescent up(20, 21)
   $\dots z_{22} \dots$  cycle;

fix_hstem( $o + .5(.5(px + u) + .5py + u)$ )(glyph_stored.glyph_name 1,
  glyph_stored.glyph_name 2);
fix_vstem( $o + .5(.5(px + u) + .5py + u)$ )(glyph_stored.glyph_name 1,
  glyph_stored.glyph_name 2);
fix_hstem(.5py)(glyph_stored.glyph_name 3);
fix_vstem(.5(px + u))(glyph_stored.glyph_name 3);
fix_dimens( $x_1 + \text{rightbear} - o, y_2, y_0, 0$ );

just_labels bot(0, 4, 8, 9, 13, 15, 16, 18);
just_labels top(2, 6, 10, 11, 14, 17, 21, 22);
just_labels lft(3, 5);
just_labels rt(1, 7, 12, 19, 20);

standard_exact_hsbw("registered");
endglyph;

```

Construction of the character macron:

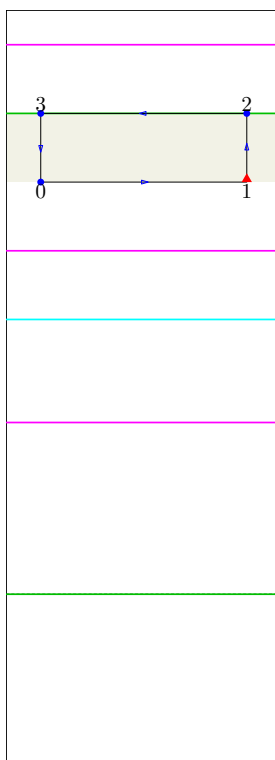

```

encode("macron")(175); standard_introduce("macron");
beginglyph(macron);
 $x_0 = x_3 = \textit{leftstemloc}$ ;
 $y_0 = y_1 = \textit{lc\_height} + 2xu$ ;  $y_3 - y_0 = y_2 - y_1 = py$ ;
 $x_2 - x_3 = x_1 - x_0 = 6xu$ ;
Fill  $z_0$  --  $z_1$  --  $z_2$  --  $z_3$  -- cycle;

fix_hstem(py)(glyph_stored.glyph_name 1);
fix_dimens( $x_1 + \textit{rightbear}$ ,  $y_2$ , 0, 0);

just_labels bot(0, 1);
just_labels top(2, 3);
standard_exact_hsbw("macron");
endglyph;

```

Construction of the character degree:

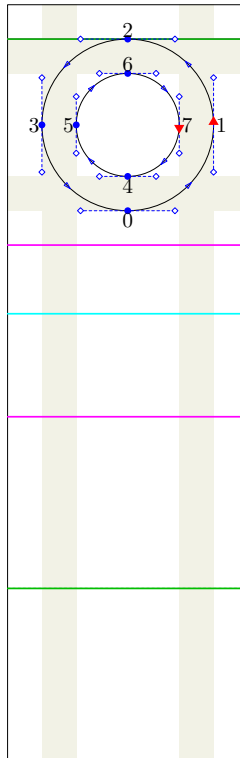

```

encode("degree")(176); standard_introduce("degree");
beginglyph(degree);
x3 = leftstemloc; y2 = uc_height;
x1 - x3 = y2 - y0 = 5xu; x2 = x0 = x6 = x4 = .5[x3, x1] = .5[x5, x7];
x7 - x5 = y6 - y4 = 3xu; y3 = y5 = y7 = y1 = .5[y0, y2] = .5[y4, y6];

Fill z0 .. z1 .. z2 .. z3 .. cycle;
unFill z4 .. z5 .. z6 .. z7 .. cycle;

fix_hstem(y4 - y0)(glyph_stored.glyph_name 1, glyph_stored.glyph_name 2);
fix_vstem(x5 - x3)(glyph_stored.glyph_name 1, glyph_stored.glyph_name 2);
fix_dimens(x1 + rightbear, y2, 0, 0);

just_labels bot(0, 4);
just_labels top(2, 6);
just_labels lft(3, 5);
just_labels rt(1, 7);

standard_exact_hsbw("degree");
endglyph;

```

Construction of the character plusminus:

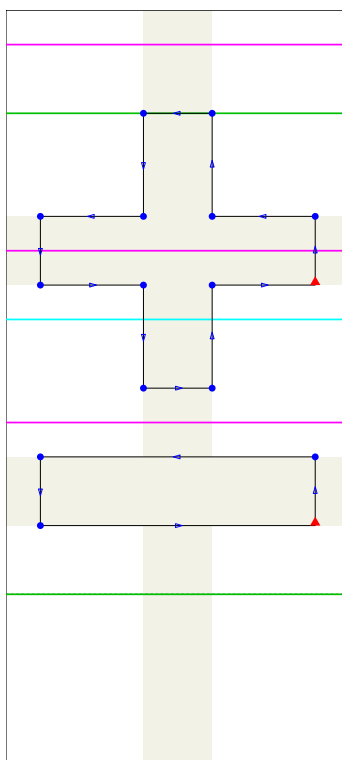

```

encode("plusminus")(177); standard_introduce("plusminus");
beginglyph(plusminus);
use_glyph(plus)(0, .5(py + 2xu));
use_glyph(minus)(0, -3xu - .5(py + 2xu));
fix_dimens(wd.plus, ht.plus + .5(py + 2xu), 0, 0);
standard_exact_hsbw("plusminus");
endglyph;

```

Construction of the character twosuperior:

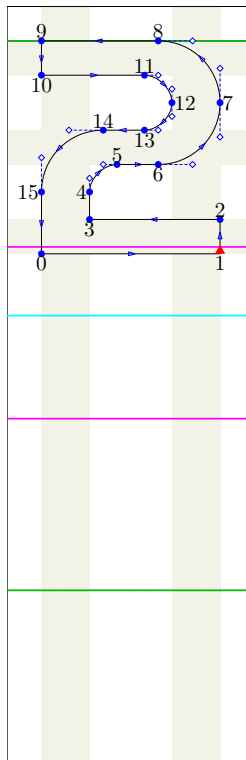

```

encode("twosuperior")(178); standard_introduce("twosuperior");
beginglyph(twosuperior);
y0 = y1 = lc_height - u; x9 = x10 = x15 = x0 = leftstemloc; y8 = y9 = uc_height;
x4 - x15 = x7 - x12 = x3 - x0 = .5(px - u); x13 - x5 = 4u; x2 = x1 = x7;
y3 - y0 = y2 - y1 = y9 - y10 = y8 - y11 = .5py; y14 = y13; y5 = y6;
z5 = z4 + (.4ibow, .4ibow); z7 = z6 + (.45obow, .45obow); z8 = z7 + (-.45obow, .45obow);
z12 = z11 + (.4ibow, -.4ibow); z13 = z12 - (.4ibow, .4ibow); z15 = z14 - (.45obow, .45obow);

Fill z0 -- z1 -- z2 -- z3 -- mini_bow up(4, 5)
  -- med_crescent right(6, 7) & med_crescent up(7, 8) -- z9 -- z10
  -- mini_bow right(11, 12) & mini_bow down(12, 13)
  -- med_crescent left(14, 15) -- cycle;

fix_vstem(.5(px - u))(glyph_stored.glyph_name 1);
fix_hstem(.5py)(glyph_stored.glyph_name 1);
fix_dimens(round(x1 + rightbear), y8, 0, 0);

just_labels bot(0, 1, 3, 6, 10, 13);
just_labels top(2, 5, 8, 9, 11, 14);
just_labels rt(7, 12);
just_labels lft(4, 15);

standard_exact_hsbw("twosuperior");
endglyph;

```

Construction of the character threesuperior:

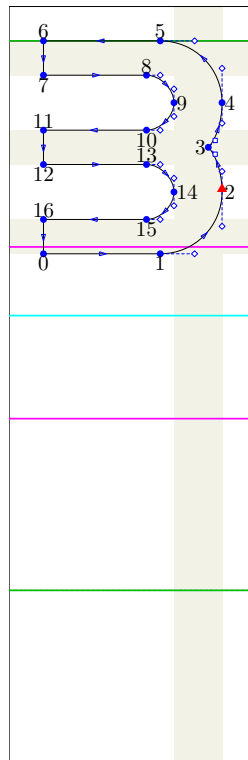

```
encode("threesuperior")(179); standard_introduce("threesuperior");
beginlyph(threesuperior);
```

```
y0 = y1 = lc_height - u; x0 = x6 = x7 = x11 = x12 = x16 = leftstemloc; y5 = y6 = uc_height;
x2 - x14 = x4 - x9 = .5(px - u); x13 - x12 = x10 - x11 = 3xu; x2 - x3 = 2u;
y16 - y0 = y15 - y1 = y5 - y8 = y6 - y7 = .5py; y3 = .5[y2, y4]; y11 = y10; y12 = y13;
z2 = z1 + (.45obow, .45obow); z5 = z4 + (-.45obow, .45obow); z9 = z8 + (.4ibow, -.4ibow);
z10 = z9 - (.4ibow, .4ibow); z14 = z13 + (.4ibow, -.4ibow); z15 = z14 - (.4ibow, .4ibow);
```

```
Fill z0 -- med_crescent right(1, 2) .. controls(x2, y2 + 3u) and (x3 + u, y3 - u)
.. z3 .. controls(x3 + u, y3 + u) and (x4, y4 - 3u) .. med_crescent up(4, 5) -- z6
-- z7 -- mini_bow right(8, 9) & mini_bow down(9, 10) -- z11 -- z12
-- mini_bow right(13, 14) & mini_bow down(14, 15) -- z16 -- cycle;
```

```
fix_vstem(.5(px - u))(glyph_stored.glyph_name 1);
fix_hstem(.5py)(glyph_stored.glyph_name 1);
fix_dimens(round(x2 + rightbear), y5, 0, 0);
```

```
just_labels bot(0, 1, 7, 10, 12, 15);
just_labels top(5, 6, 8, 11, 13, 16);
just_labels rt(2, 4, 9, 14);
just_labels lft(3);
```

```
standard_exact_hsbw("threesuperior");
endglyph;
```

Construction of the character foursuperior:

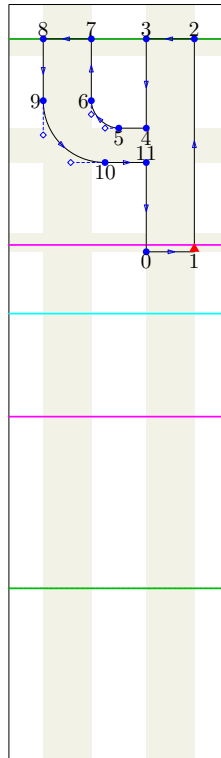

```

standard_introduce("foursuperior");
beginglyph(foursuperior);
y0 = y1 = lc_height - u; x8 = x9 = leftstemloc; y2 = y3 = y7 = y8 = uc_height;
x7 - x8 = x6 - x9 = x2 - x3 = x1 - x0 = .5(px - u);
x0 = x3 = x4 = x11 = x5 + 4u;
.5[y10, y5] = .5[y11, y4] = .5[y0, y3]; y4 - y11 = y5 - y10 = .5py;
z6 = z5 + (-.4ibow, .4ibow); z10 = z9 + (.45obow, -.45obow);

Fill z0 -- z1 -- z2 -- z3 -- z4 -- mini_bow left(5, 6) -- z7 -- z8 -- med_crescent down(9, 10)
-- z11 -- cycle;

fix_hstem(.5py)(glyph_stored.glyph_name 1);
fix_vstem(.5(px - u))(glyph_stored.glyph_name 1);
fix_dimens(round(x1 + rightbear), y2, 0, 0);

ghost_stem top, bot;

just_labels bot(0, 1, 4, 5, 10);
just_labels top(2, 3, 7, 8, 11);
just_labels lft(6, 9);

standard_exact_hsbw("foursuperior");
endglyph;

```

Construction of the character acute:

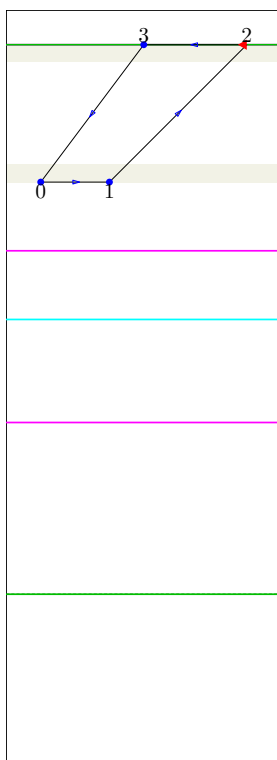

```

encode("acute")(180); standard_introduce("acute");
begin_glyph(acute);
 $x_0 = \text{leftstemloc}$ ;
 $x_2 - x_3 = px = x_1 - x_0 + xu$ ;  $y_3 - y_0 = y_2 - y_1 = 4xu$ ;
 $x_3 - x_0 = 3xu$ ;
 $y_0 = y_1 = \text{lc.height} + 2xu$ ;
Fill  $z_0$  --  $z_1$  --  $z_2$  --  $z_3$  -- cycle;
ghost_stem top, bot;
fix_dimens( $x_2 + \text{rightbear}$ ,  $y_2$ , 0, 0);
just_labels bot(0, 1);
just_labels top(2, 3);
standard_exact_hsbw("acute");
end_glyph;

```

Construction of the character mu:

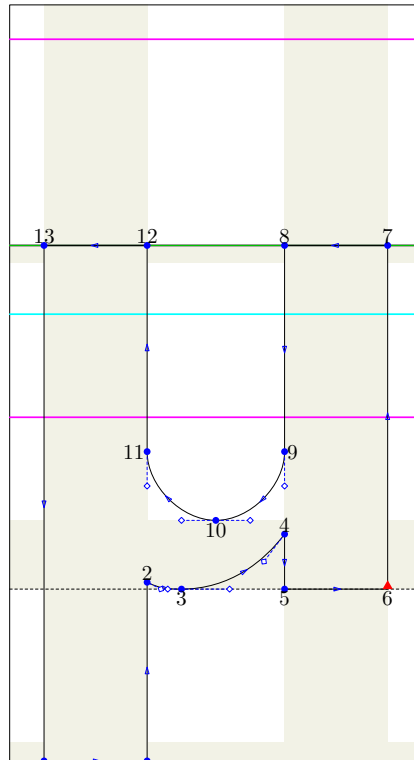

```

encode("mu")(181); standard_introduce("mu");
begin_glyph(mu);
y3 = y5 = y6 = 0; x0 = x13 = leftstemloc; y7 = y8 = y12 = y13 = lc_height;
x1 - x0 = x2 - x0 = x11 - x13 = x12 - x13 = x6 - x5 = x7 - x8 = px; x5 = x4 = x8 = x9;
y10 - y3 = py; y0 = y1 = descender; y2 - y3 = u;
z4 = z3 + (obow - xu, .4obow); z10 = z9 - (ibow, ibow); z11 = z10 + (-ibow, ibow);

Fill z0 -- z1 -- z2 .. controls(x2 + 2u, y2 - u) and (x3 - 2u, y3) .. z3
.. controls(x3 + .7octl, y3) and (x4 - .3octl, y4 - .4octl) .. z4 -- z5 -- z6 -- z7 -- z8
-- bow down(9, 10) & bow left(10, 11) -- z12 -- z13 -- cycle;

fix_vstem(px)(glyph_stored.glyph_name 1);
fix_hstem(py)(glyph_stored.glyph_name 1);
ghost_stem bot, top;
fix_dimens(x6 + rightbear, y7, y0, 0);

just_labels bot(0, 1, 3, 5, 6, 10);
just_labels top(2, 4, 7, 8, 12, 13);
just_labels rt(9);
just_labels lft(11);

standard_exact_hsbw("mu");
end_glyph;

```

Construction of the character paragraph:

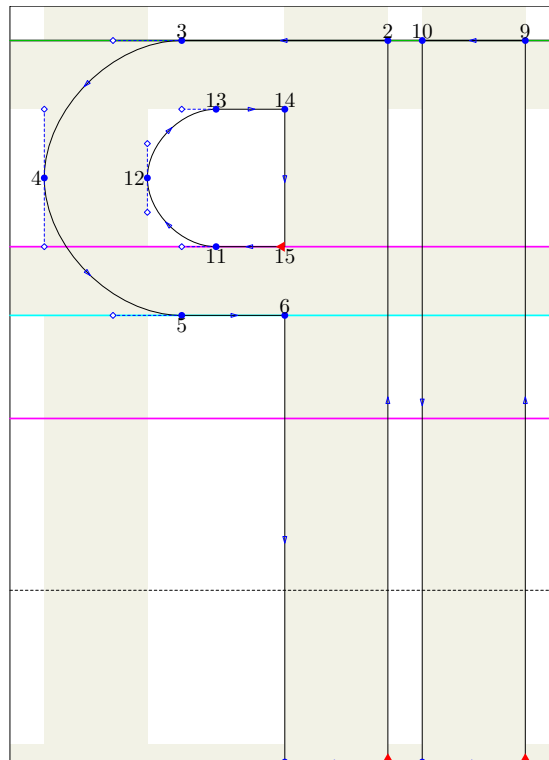

```

encode("paragraph")(182); standard_introduce("paragraph");
beginlyph(paragraph);
 $y_0 = y_1 = y_7 = y_8 = \text{descender}$ ;  $x_4 = \text{leftstemloc}$ ;  $y_9 = y_{10} = y_2 = y_3 = \text{uc\_height}$ ;
 $x_1 - x_0 = x_1 - x_6 = x_2 - x_{15} = x_2 - x_{14} = x_9 - x_{10}$ 
 $= x_8 - x_7 = x_{12} - x_4 = px$ ;  $x_{15} - x_{11} = 2xu$ ;  $x_{15} = x_6$ ;  $x_{10} - x_2 = x_7 - x_1 = xu$ ;
 $y_3 - y_{13} = y_2 - y_{14} = y_{11} - y_5 = y_{15} - y_6 = py$ ;  $y_{15} = y_{11}$ ;
 $z_4 = z_3 - (\text{obow}, \text{obow})$ ;  $z_5 = z_4 + (\text{obow}, -\text{obow})$ ;  $z_{12} = z_{11} + (-\text{ibow}, \text{ibow})$ ;  $z_{13} = z_{12} + (\text{ibow}, \text{ibow})$ ;

Fill  $z_0$  --  $z_1$  --  $z_2$  -- crescent left(3, 4) & crescent down(4, 5) --  $z_6$  -- cycle,
 $z_7$  --  $z_8$  --  $z_9$  --  $z_{10}$  -- cycle;
unFill bow left(11, 12) & bow up(12, 13) --  $z_{14}$  --  $z_{15}$  -- cycle;

fix_vstem( $px$ )(glyph_stored.glyph_name 1, glyph_stored.glyph_name 2,
glyph_stored.glyph_name 3);
fix_hstem( $py$ )(glyph_stored.glyph_name 1, glyph_stored.glyph_name 3);
fix_dimens( $x_8 + \text{rightbear}$ ,  $y_9$ ,  $y_0$ , 0);
ghost_stem bot;

just_labels bot(0, 1, 5, 7, 8, 11, 15);
just_labels top(2, 3, 6, 9, 10, 13, 14);
just_labels lft(4, 12);

standard_exact_hsbw("paragraph");
endglyph;

```

Construction of the character periodcentered:

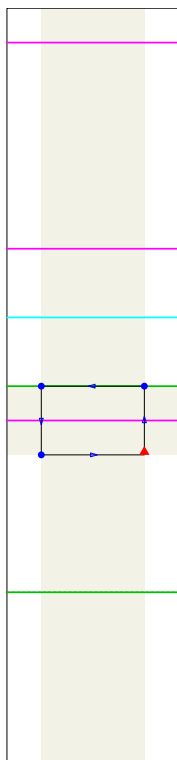

```
encode("periodcentered")(183); standard_introduce("periodcentered");
begin_glyph(periodcentered);
use_glyph(period)(0, .5lc_height - .5py);
fix_dimens(wd.period, ht.period + .5lc_height - .5py, 0, 0);
standard_exact_hsbw("periodcentered");
end_glyph;
```

Construction of the character cedilla:

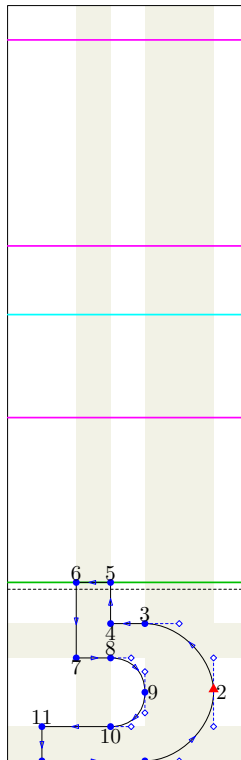

```

encode("cedilla")(184); standard_introduce("cedilla");
beginglyph(cedilla);
y0 = y1 = descender; x0 = x11 = leftstemloc; y6 = y5 = u;
x5 - x6 = x4 - x7 = xu; x2 - x9 = 2xu; x10 - x11 = 2xu; x8 - x7 = xu; x6 = x7;
y11 - y0 = y10 - y1 = xu; y4 = y3; y7 = y8;
z2 = z1 + (.5obow, .5obow); z3 = z2 + (-.5obow, .5obow); z9 = z8 + (.5ibow, -.5ibow);
z10 = z9 - (.5ibow, .5ibow);
hv0 := x6; hv1 := x5;

Fill z0 -- med_crescent_right(1, 2) & med_crescent_up(2, 3) -- z4
  -- z5 -- z6 -- z7 -- small_bow_right(8, 9) & small_bow_down(9, 10) -- z11 -- cycle;

fix_vstem(xu)(glyph_stored.glyph_name 1)((x >= hv0) and (x <= hv1));
fix_vstem(2xu)(glyph_stored.glyph_name 1)(x > hv1);
fix_hstem(xu)(glyph_stored.glyph_name 1);
fix_dimens(x2 + rightbear, y5, y0, 0);

just_labels bot(0, 1, 4, 7, 10);
just_labels top(3, 5, 6, 8, 11);
just_labels rt(2, 9);

standard_exact_hsbw("cedilla");
endglyph;

```

Construction of the character onesuperior:

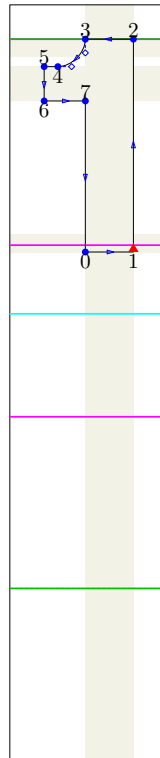

```

encode("onesuperior")(185); standard_introduce("onesuperior");
begin_glyph(onesuperior);
 $y_0 = y_1 = lc\_height - u$ ;  $x_5 = x_6 = leftstemloc$ ;  $y_2 = y_3 = uc\_height$ ;
 $x_0 = x_3 = x_7$ ;  $x_4 - x_5 = 2u$ ;  $x_1 - x_0 = x_2 - x_3 = .5(px - u)$ ;  $y_5 - y_6 = y_4 - y_7 = .5py$ ;  $y_5 = y_4$ ;
 $z_4 = z_3 - (.4ibow, .4ibow)$ ;

Fill  $z_0$  --  $z_1$  --  $z_2$  -- mini_bow down(3, 4) --  $z_5$  --  $z_6$  --  $z_7$  -- cycle;

fix_hstem(.5py)(glyph_stored.glyph_name 1)( $y < uc\_height$ );
fix_vstem(.5(px - u))(glyph_stored.glyph_name 1)( $x > leftstemloc$ );
fix_dimens(round( $x_1 + rightbear$ ),  $y_3$ , 0, 0);
ghost_stem bot, top;

just_labels bot(0, 1, 4, 6);
just_labels top(2, 3, 5, 7);

standard_exact_hsbw("onesuperior");
end_glyph;

```

Construction of the character ordmasculine:

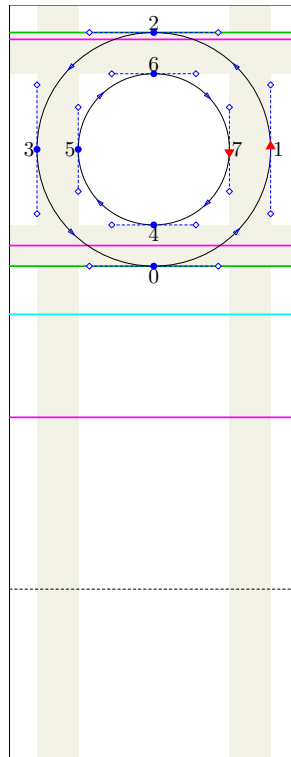

```

encode("ordmasculine")(186); standard_introduce("ordmasculine");
beginglyph(ordmasculine);
 $y_0 = lc\_height - 2u - o;$   $x_3 = leftstemloc - o;$   $y_2 = uc\_height + o;$ 
 $y_2 - y_6 = y_4 - y_0 = x_5 - x_3 = x_1 - x_7 = xu + o;$ 
 $x_1 - x_3 = y_2 - y_0;$ 
 $x_2 = x_6 = x_4 = x_0 = .5[x_3, x_1];$ 
 $y_3 = y_5 = y_7 = y_1 = .5[y_0, y_2];$ 

Fill  $z_0 \dots z_1 \dots z_2 \dots z_3 \dots$  cycle;
unFill  $z_4 \dots z_5 \dots z_6 \dots z_7 \dots$  cycle;

fix_vstem( $xu + o$ )(glyph_stored.glyph_name 1, glyph_stored.glyph_name 2);
fix_hstem( $xu + o$ )(glyph_stored.glyph_name 1, glyph_stored.glyph_name 2);
fix_dims( $x_1 + rightbear - o, y_2, y_0, 0$ );

just_labels bot(0, 4);
just_labels top(2, 6);
just_labels rt(1, 7);
just_labels lft(3, 5);

standard_exact_hsbw("ordmasculine");
endglyph;

```

Construction of the character guillemotright:

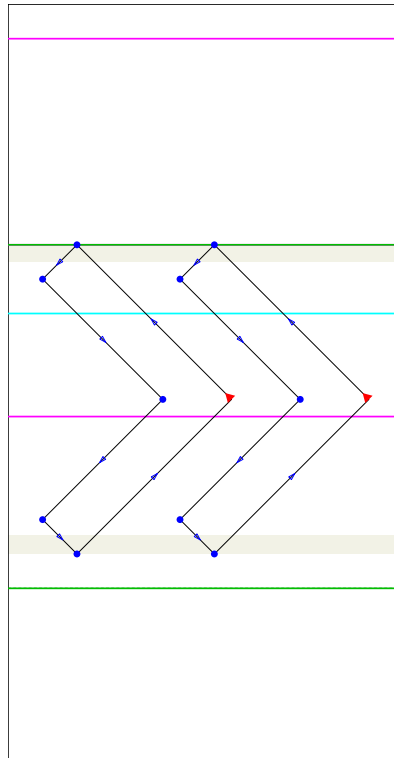

```

encode("guillemotright")(187); standard_introduce("guillemotright");
begin_glyph(guillemotright);
use_glyph(guilsinglright);
use_glyph(guilsinglright)(2xu + 2xu);
fix_dimens(wd.guilsinglright + 2xu + 2xu, ht.guilsinglright, 0, 0);
standard_exact_hsbw("guillemotright");
end_glyph;

```

Construction of the character onequarter:

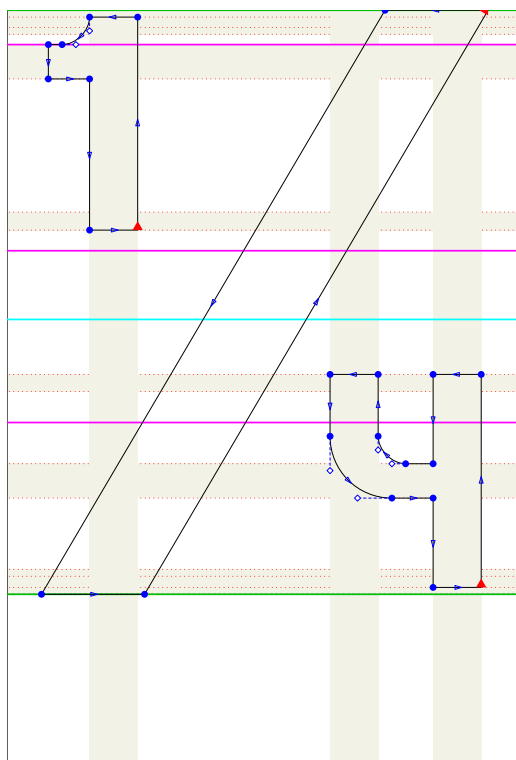

```

encode("onequarter")(188); standard_introduce("onequarter");
begin_glyph(onequarter);
use_glyph(fraction);
use_glyph(onesuperior)(u, ascender - uc_height - u);
use_glyph(foursuperior)(wd.fraction - wd.foursuperior - u, -lc_height + u + u);
fix_dimens(wd.fraction, ht.fraction, 0, 0);
ghost_stem bot, top;
standard_exact_hsbw("onequarter");
end_glyph;

```

Construction of the character onehalf:

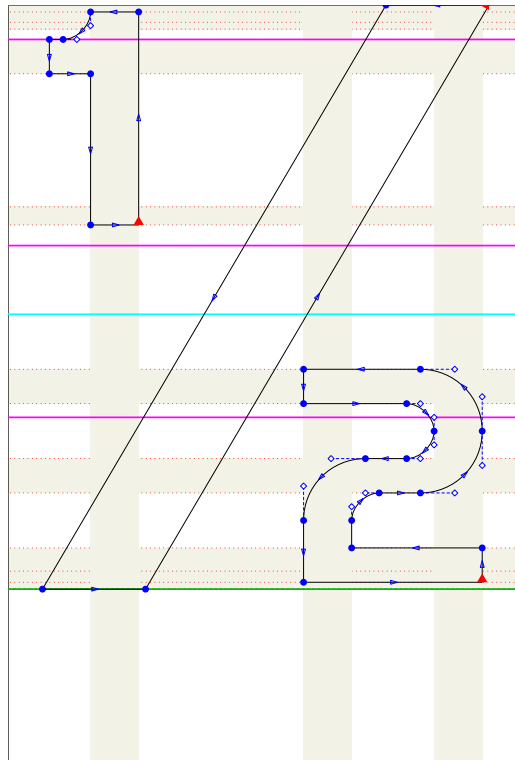

```

encode("onehalf")(189); standard_introduce("onehalf");
begin_glyph(onehalf);
use_glyph(fraction);
use_glyph(onesuperior)(u, ascender - uc_height - u);
use_glyph(twosuperior)(wd.fraction - wd.twosuperior - u, -lc_height + u + u);

fix_dimens(wd.fraction, ht.fraction, 0, 0);

ghost_stem bot, top;

standard_exact_hsbw("onehalf");
end_glyph;

```

Construction of the character threequarters:

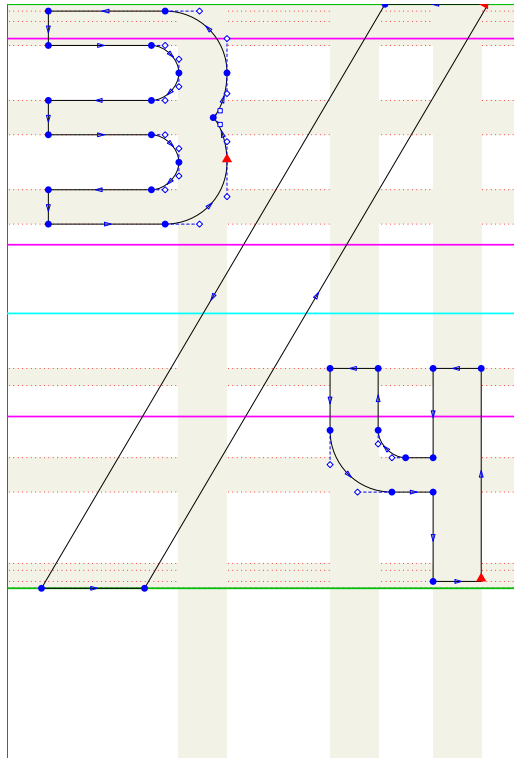

```

encode("threequarters")(190); standard_introduce("threequarters");
beginglyph(threequarters);
use_glyph(fraction);
use_glyph(threesuperior)(u, ascender - uc_height - u);
use_glyph(foursuperior)(wd.fraction - wd.foursuperior - u, -lc_height + u + u);
fix_dimens(wd.fraction, ht.fraction, 0, 0);
ghost_stem bot, top;
standard_exact_hsbw("threequarters");
endglyph;

```

Construction of the character questiondown:

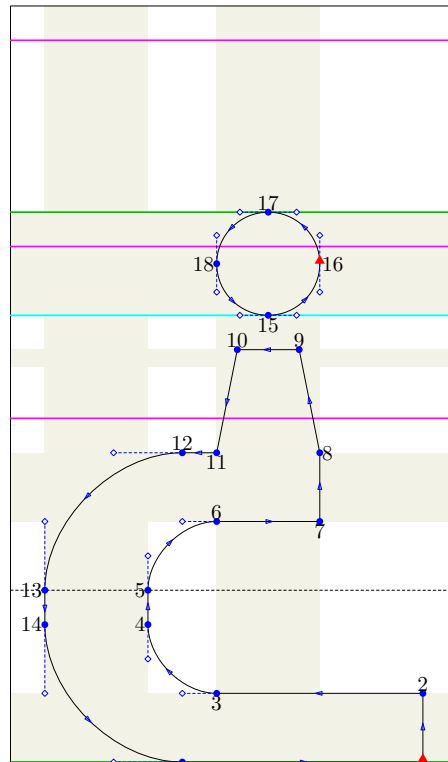

```

encode("questiondown")(191); standard_introduce("questiondown");
beginglyph(questiondown);
 $y_{13} = y_5 = 0; x_{13} = x_{14} = \text{leftstemloc};$ 
 $x_4 - x_{14} = x_5 - x_{13} = x_7 - x_6 = x_8 - x_{11} = px = x_{16} - x_{18} = y_{17} - y_{15};$ 
 $x_{17} = x_{15} = .5[x_{18}, x_{16}] = .5[x_{11}, x_8]; x_{10} - x_{11} = x_8 - x_9 = 3u; x_2 - x_7 = 3xu; x_1 = x_2; x_7 = x_8;$ 
 $y_2 - y_1 = y_3 - y_0 = y_8 - y_7 = y_{11} - y_6 = py; y_0 = y_1 = \text{descender}; y_{15} - y_{10} = y_{15} - y_9 = xu;$ 
 $y_{17} - y_0 = \text{uc\_height}; y_7 = y_6; y_{16} = y_{18} = .5[y_{15}, y_{17}];$ 
 $z_4 = z_3 + (-\text{ibow}, \text{ibow}); z_6 = z_5 + (\text{ibow}, \text{ibow}); z_{13} = z_{12} - (\text{obow}, \text{obow}); z_0 = z_{14} + (\text{obow}, -\text{obow});$ 
 $hv_0 := x_1;$ 
Fill  $z_0$  --  $z_1$  --  $z_2$  -- bow left(3, 4) -- bow up(5, 6) --  $z_7$  --  $z_8$  --  $z_9$  --  $z_{10}$  --  $z_{11}$ 
  -- crest left(12, 13) -- crest down(14, 0) & cycle,
   $z_{15} \dots z_{16} \dots z_{17} \dots z_{18} \dots$  cycle;
fix_vstem(px)(glyph_stored.glyph_name 1, glyph_stored.glyph_name 2)( $x < hv_0$ );
fix_hstem(px)(glyph_stored.glyph_name 2);
fix_hstem(py)(glyph_stored.glyph_name 1, glyph_stored.glyph_name 2);
fix_dimens( $x_1 + \text{rightbear}$ ,  $y_{17}$ ,  $y_0$ , 0);
ghost_stem top( $y_{10}$ );
just_labels bot(0, 1, 3, 7, 11, 15);
just_labels top(2, 6, 9, 10, 12, 17);
just_labels rt(8, 16);
just_labels lft(4, 5, 13, 14, 18);
standard_exact_hsbw("questiondown");
endglyph;

```

Construction of the character Agrave:

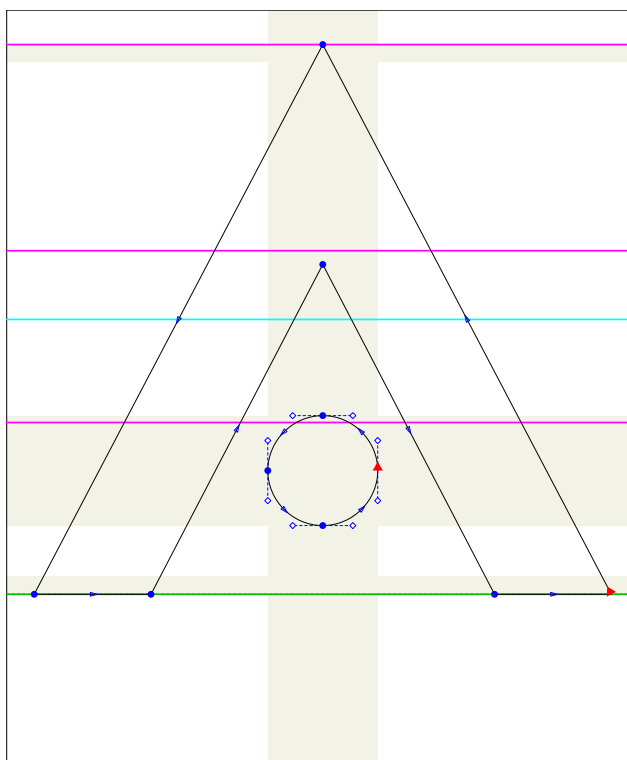

```

encode("Agrave")(192); standard_introduce("Agrave");
beginlyph(Agrave);
use_accent(A, grave);

fix_dimens(wd.A, ht.A + ht.grave - lc_height, 0, 0);
standard_exact_hsbw("Agrave");
endlyph;

```

Construction of the character Aacute:

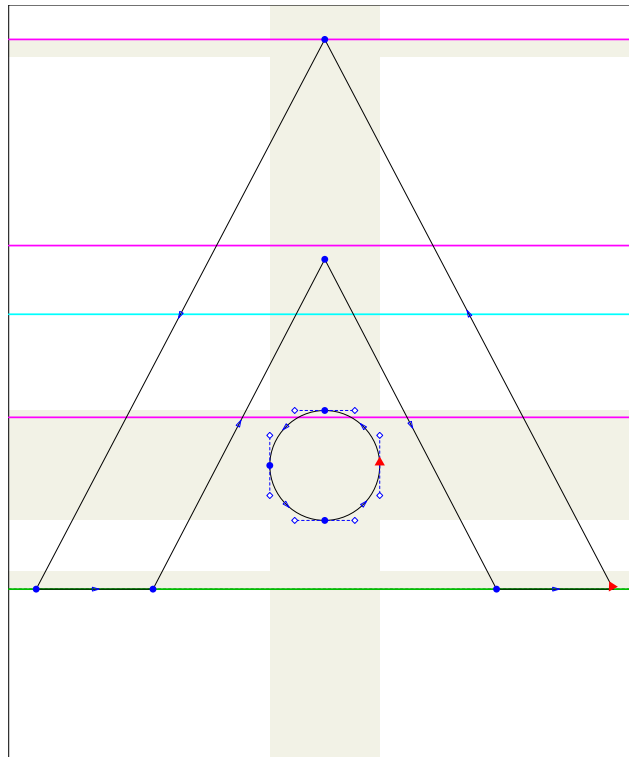

```

encode("Aacute")(193); standard_introduce("Aacute");
begin_glyph(Aacute);
use_accent(A, acute);
fix_dimens(wd.A, ht.A + ht.acute - lc_height, 0, 0);
standard_exact_hsbw("Aacute");
end_glyph;

```

Construction of the character Acircumflex:

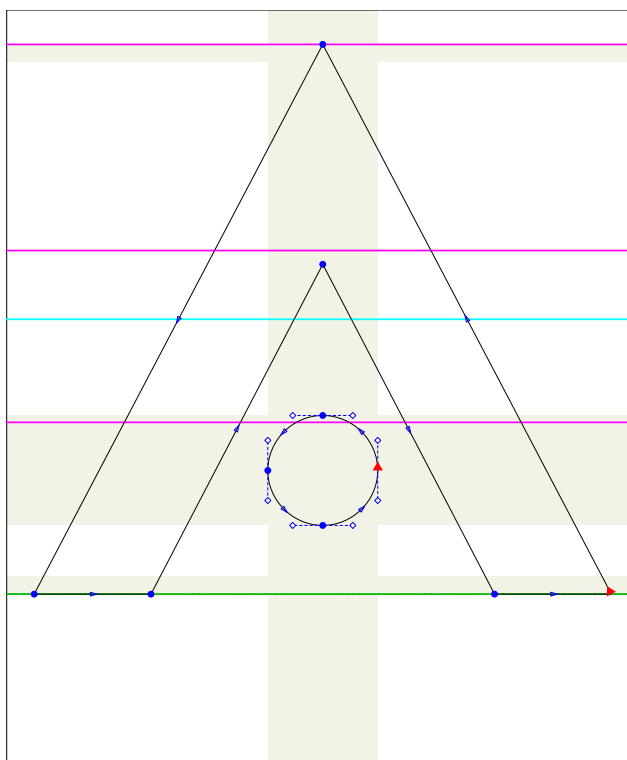

```

encode("Acircumflex")(194); standard_introduce("Acircumflex");
beginlyph(Acircumflex);
use_accent(A, circumflex);
fix_dimens(wd.A, ht.A + ht.circumflex - lc.height, 0, 0);
standard_exact_hsbw("Acircumflex");
endglyph;

```

Construction of the character Atilde:

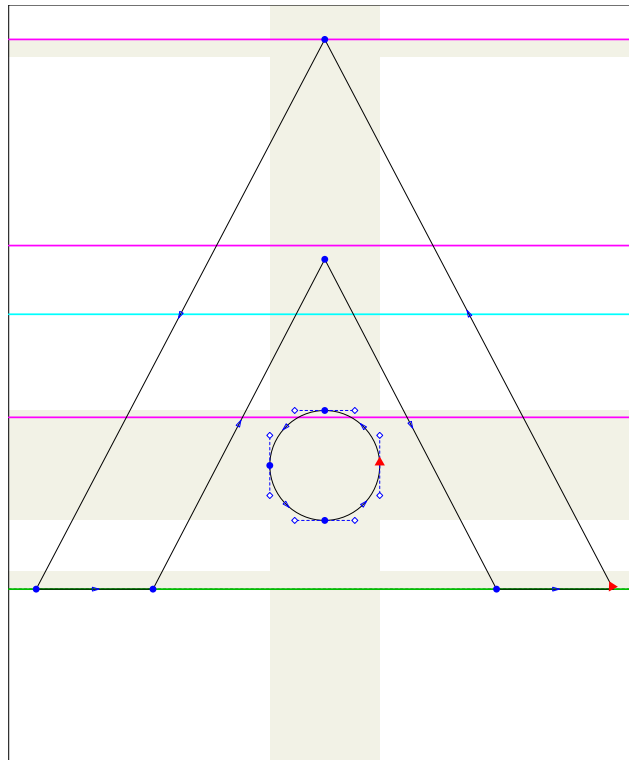

```

encode("Atilde")(195); standard_introduce("Atilde");
begin_glyph(Atilde);
use_accent(A, tilde);
fix_dimens(wd.A, ht.A + ht.tilde, 0, 0);
standard_exact_hsbw("Atilde");
end_glyph;

```

Construction of the character Adieresis:

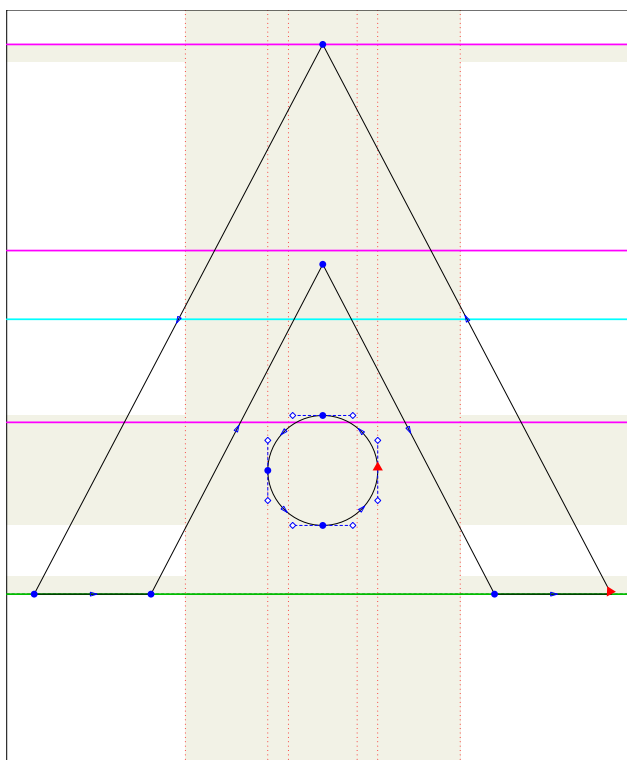

```

encode("Adieresis")(196); standard_introduce("Adieresis");
beginlyph(Adieresis);
use_accent(A, dieresis);

fix_dimens(wd.A, ht.A + ht.dieresis - lc.height, 0, 0);

standard_exact_hsbw("Adieresis");
endglyph;

```

Construction of the character Aring:

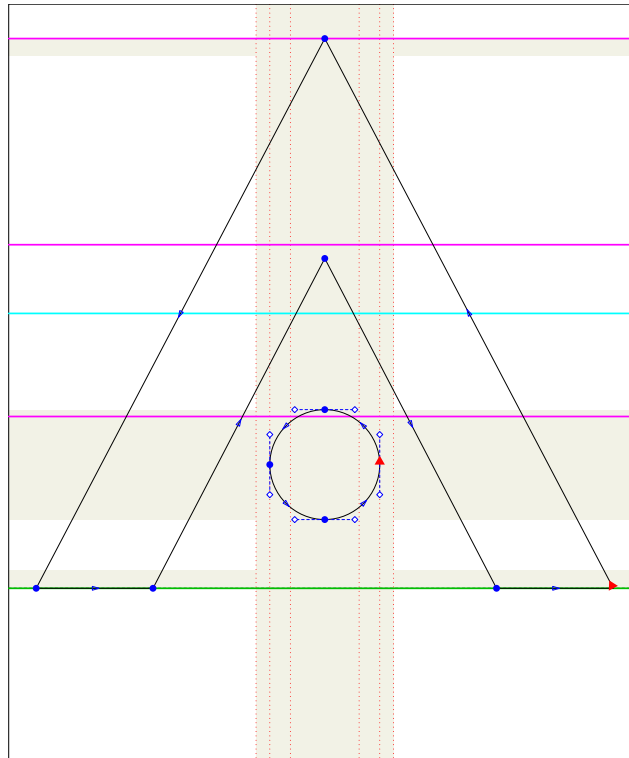

```

encode("Aring")(197); standard_introduce("Aring");
beginlyph(Aring);
use_accent(A, ring);

fix_dimens(wd.A, ht.A + ht.ring - lc_height, 0, 0);
standard_exact_hsbw("Aring");
endglyph;

```

Construction of the character AE:

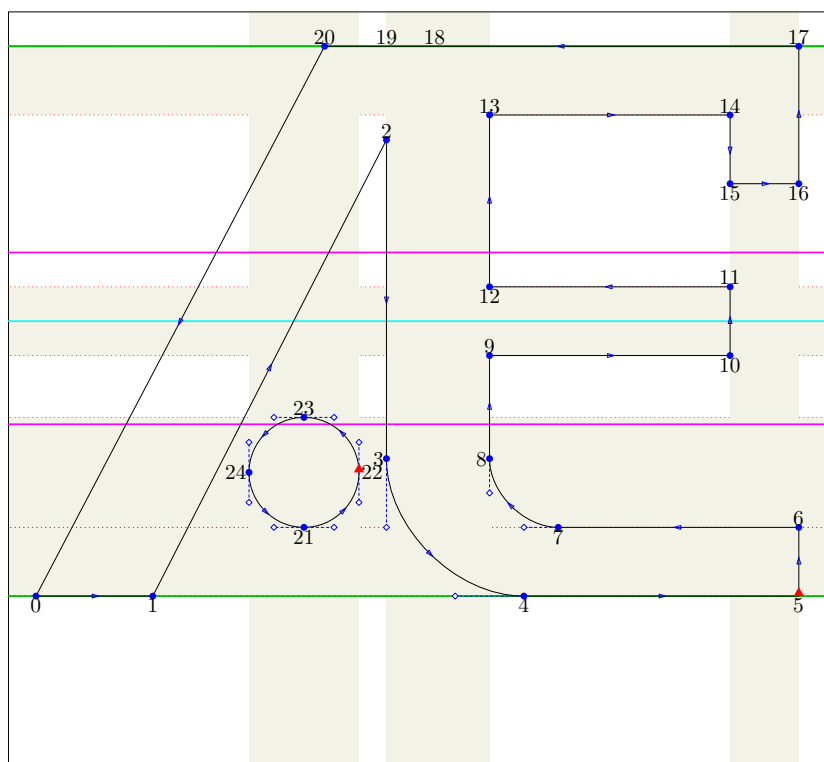

```

encode("AE")(198); standard_introduce("AE");
beginlyph(AE);
y0 = y1 = y4 = y5 = 0; x0 = leftstemloc - o; y17 = y18 = y19 = y20 = uc_height;
x1 - x0 = px + u + o; x13 - x19 = x12 - x19 = x9 - x3 = x8 - x3 = px; x22 - x24 = y23 - y21 = px + o;
x20 - x1 = 5xu; x19 = x3; x10 - x9 = x11 - x12 = x14 - x13 = 7xu; x14 = x15;
x23 = x21 = .5[x24, x22] = .5[x1 + 2xu, x3]; y22 = y24 = .5[y21, y23] = dotheight;
x6 - x10 = x16 - x15 = x17 - x14 = xgap; x5 = x6; x18 - x19 = xu + 2u;
x18 - x20 = px + u; % Like A and V no overshoot, to make the bar subtly lighter.
.5[y9, y12] = .5[y10, y11] = .5uc_height;
y11 - y10 = y12 - y9 = y6 - y5 = y7 - y4
= y19 - y13 = y17 - y14 = py; y14 - y15 = 2xu; y16 = y15;
z4 = z3 + (obow, -obow); z8 = z7 + (-ibow, ibow);
z2 = whatever[z1, z18] = whatever[z3, z19];
hh0 := y15; hh1 := y13;

Fill z0 -- z1 -- z2 -- crescent down(3, 4) -- z5 -- z6 -- bow left(7, 8) -- z9 -- z10 -- z11
-- z12 -- z13 -- z14 -- z15 -- z16 -- z17 -- z20 -- cycle, z21 .. z22 .. z23 .. z24 .. cycle;

fix_hstem(py)(glyph_stored.glyph_name 1)((y < hh0) or (y >= hh1));
fix_vstem(px)(glyph_stored.glyph_name 1);
fix_vstem(xgap)(glyph_stored.glyph_name 1);
fix_hstem(px + o)(glyph_stored.glyph_name 2);
fix_vstem(px + o)(glyph_stored.glyph_name 2);
fix_dims(x5 + rightbear, y17, 0, 0);

just_labels bot(0, 1, 4, 5, 7, 10, 12, 15, 16, 21);
just_labels top(2, 6, 9, 11, 13, 14, 17, 18, 19, 20, 23);
just_labels lft(3, 8, 24);
just_labels rt(22);

standard_exact_hsbw("AE");
endglyph;

```

Construction of the character Ccedilla:

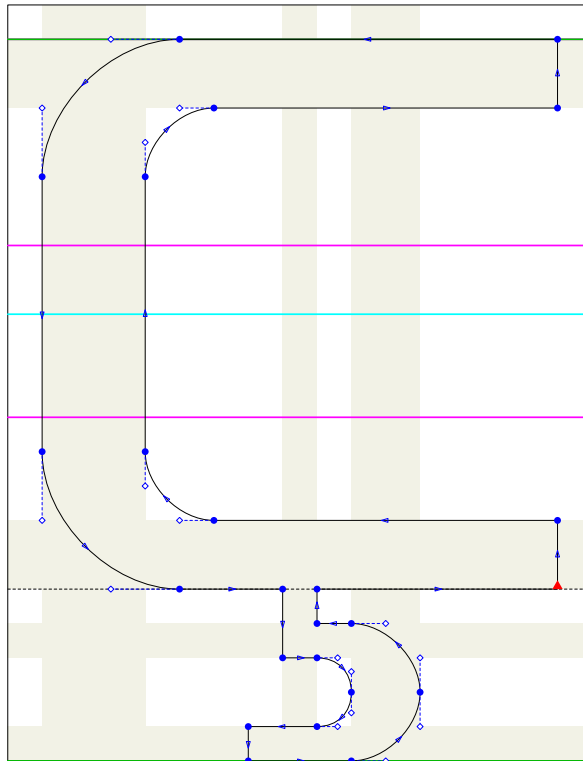

```

encode("Ccedilla")(199); standard_introduce("Ccedilla");
beginglyph(Ccedilla);
find_outlines(glyph_stored.C 1, glyph_stored.cedilla 1
  shifted (6xu, 0))(glyph);
Fill glyph1;
use_stems(C);
use_stems(cedilla)(6xu, 0);
fix_dimens(wd.C, ht.C, dp.cedilla, 0);
standard_exact_hsbw("Ccedilla");
endglyph;

```

Construction of the character Egrave:

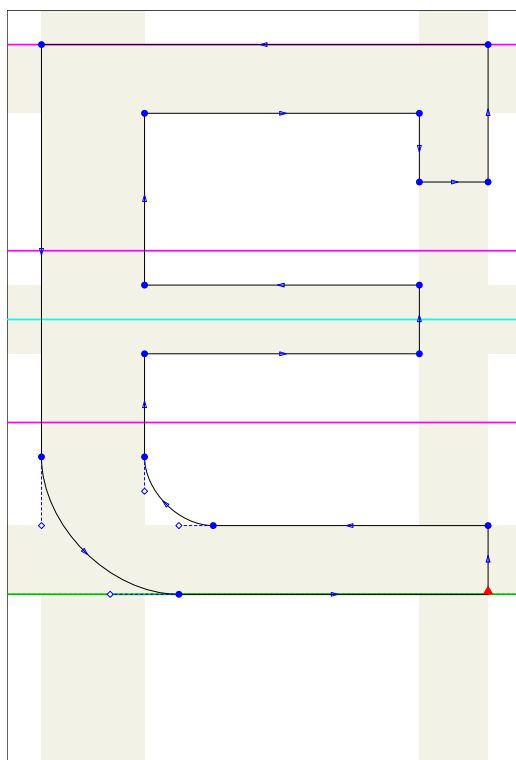

```

encode("Egrave")(200); standard_introduce("Egrave");
beginlyph(Egrave);
use_accent(E, grave);

fix_dimens(wd.E, ht.E + ht.grave - lc_height, 0, 0);
standard_exact_hsbw("Egrave");
endglyph;

```

Construction of the character Eacute:

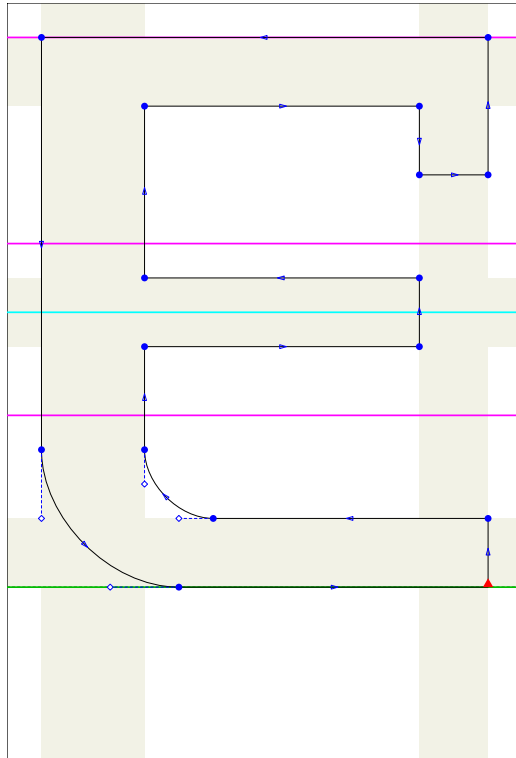

```
encode("Eacute")(201); standard_introduce("Eacute");
beginlyph(Eacute);
use_accent(E, acute);
fix_dimens(wd.E, ht.E + ht.acute - lc_height, 0, 0);
standard_exact_hsbw("Eacute");
endglyph;
```

Construction of the character Ecircumflex:

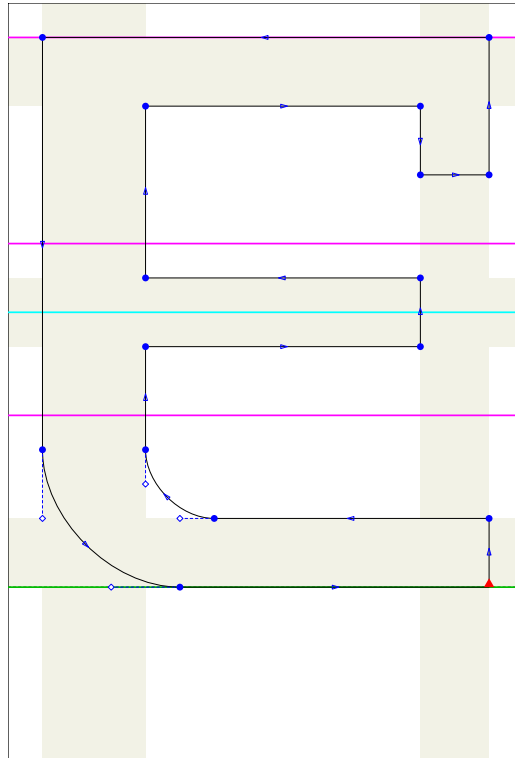

```

encode("Ecircumflex")(202); standard_introduce("Ecircumflex");
beginlyph(Ecircumflex);
use_accent(E, circumflex);

fix_dimens(wd.E, ht.E + ht.circumflex - lc_height, 0, 0);
standard_exact_hsbw("Ecircumflex");
endglyph;

```

Construction of the character Edieresis:

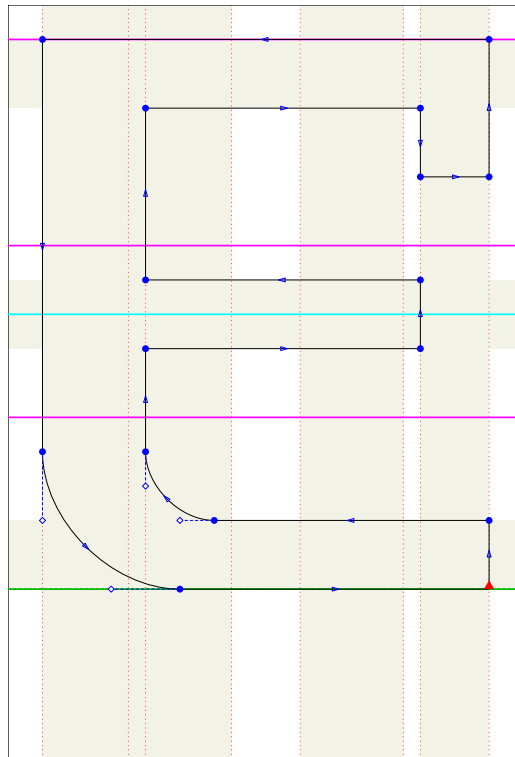

```

encode("Edieresis")(203); standard_introduce("Edieresis");
begin_glyph(Edieresis);
use_accent(E, dieresis);

fix_dimens(wd.E, ht.E + ht.dieresis - lc_height, 0, 0);

standard_exact_hsbw("Edieresis");
end_glyph;

```

Construction of the character Igrave:

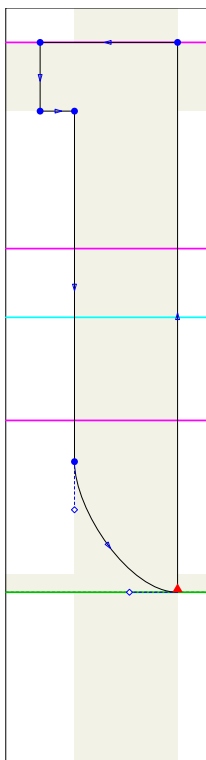

```

encode("Igrave")(204); standard_introduce("Igrave");
beginlyph(Igrave);
use_accent(I, grave);

fix_dimens(wd.l, ht.l + ht.grave - lc_height, 0, 0);
standard_exact_hsbw("Igrave");
endglyph;

```

Construction of the character Iacute:

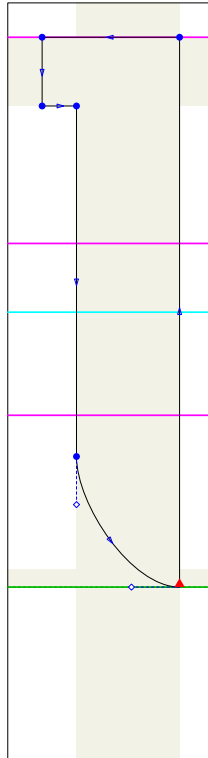

```
encode("Iacute")(205); standard_introduce("Iacute");
beginlyph(lacute);
use_accent(l, acute);
fix_dimens(wd.l, ht.l + ht.acute - lc_height, 0, 0);
standard_exact_hsbw("Iacute");
endglyph;
```

Construction of the character Icircumflex:

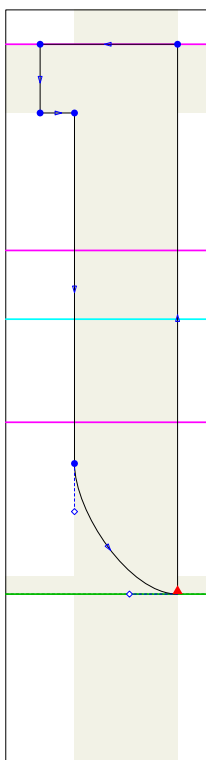

```

encode("Icircumflex")(206); standard_introduce("Icircumflex");
beginlyph(Icircumflex);
use_accent(I, circumflex);

fix_dimens(wd.I, ht.I + ht.circumflex - lc_height, 0, 0);

standard_exact_hsbw("Icircumflex");
endglyph;

```

Construction of the character Idieresis:

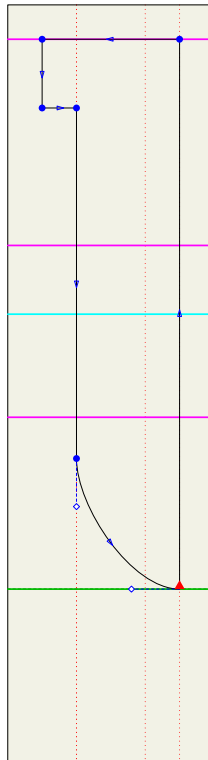

```

encode("Idieresis")(207); standard_introduce("Idieresis");
beginlyph(Idieresis);
use_accent(I, dieresis);
fix_dimens(wd.I, ht.I + ht.dieresis - lc_height, 0, 0);
standard_exact_hsbw("Idieresis");
endglyph;

```

Construction of the character Eth:

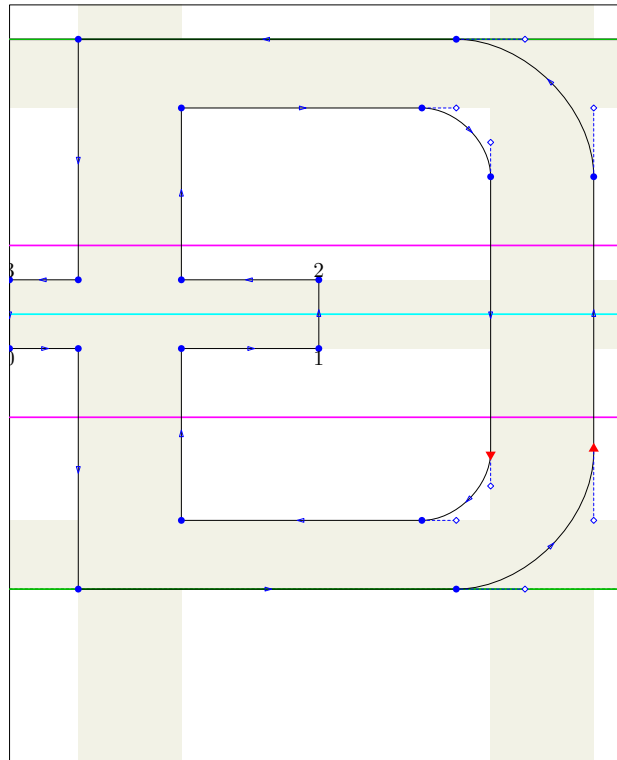

```

encode("Eth")(208); standard_introduce("Eth");
beginlyph(Eth);
 $x_0 = x_3 = \text{leftstemloc} - xu$ ;  $.5[y_0, y_3] = .5[y_1, y_2] = .5uc\_height$ ;
 $y_2 - y_1 = y_3 - y_0 = py$ ;  $x_1 - x_0 = x_2 - x_3 = \text{leftstemloc} + px + 5xu$ ;

find_outlines(glyph_stored.D 1 shifted (1xu, 0),
   $z_0 \text{ -- } z_1 \text{ -- } z_2 \text{ -- } z_3 \text{ -- cycle}$ )(glypha);
find_outlines(reverse glyph_stored.D 2 shifted (1xu, 0),
   $z_0 \text{ -- } z_3 \text{ -- } z_2 \text{ -- } z_1 \text{ -- cycle}$ )(glyphb);

Fill glypha1;
unFill reverse glyphb1;

fix_vstem(px)(glyph_stored.glyph_name 1, glyph_stored.glyph_name 2);
fix_hstem(py)(glyph_stored.glyph_name 1, glyph_stored.glyph_name 2);
fix_dimens(wd.D + xu, ht.D, 0, 0);

just_labels bot(0, 1);
just_labels top(2, 3);

standard_exact_hsbw("Eth");
endglyph;

```

Construction of the character Ntilde:

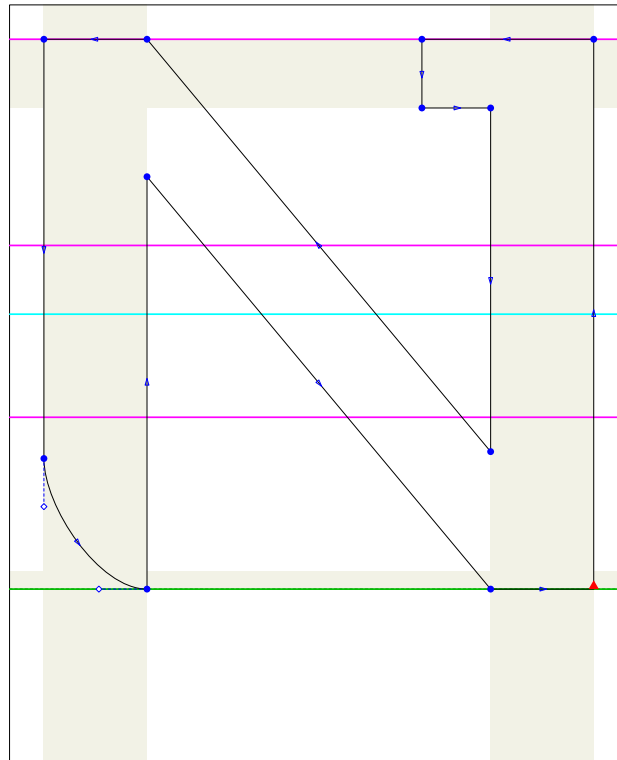

```

encode("Ntilde")(209); standard_introduce("Ntilde");
begin_glyph(Ntilde);
use_accent(N, tilde);

fix_dimens(wd.N, ht.N + ht.tilde - lc_height, 0, 0);

standard_exact_hsbw("Ntilde");
end_glyph;

```

Construction of the character Ograve:

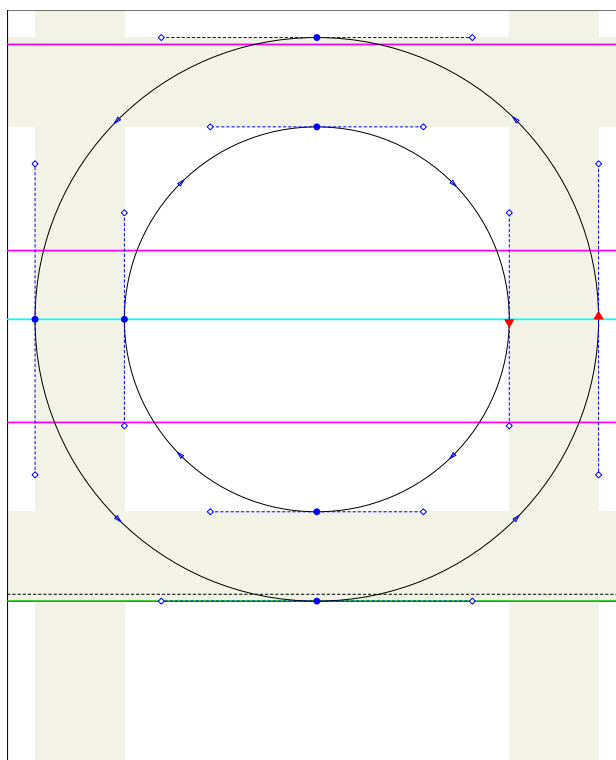

```

encode("Ograve")(210); standard_introduce("Ograve");
beginlyph(Ograve);
use_accent(O, grave)(0, -o);

fix_dimens(wd.O, ht.O + ht.grave - lc.height - o, dp.O, 0);

standard_exact_hsbw("Ograve");
endglyph;

```

Construction of the character Oacute:

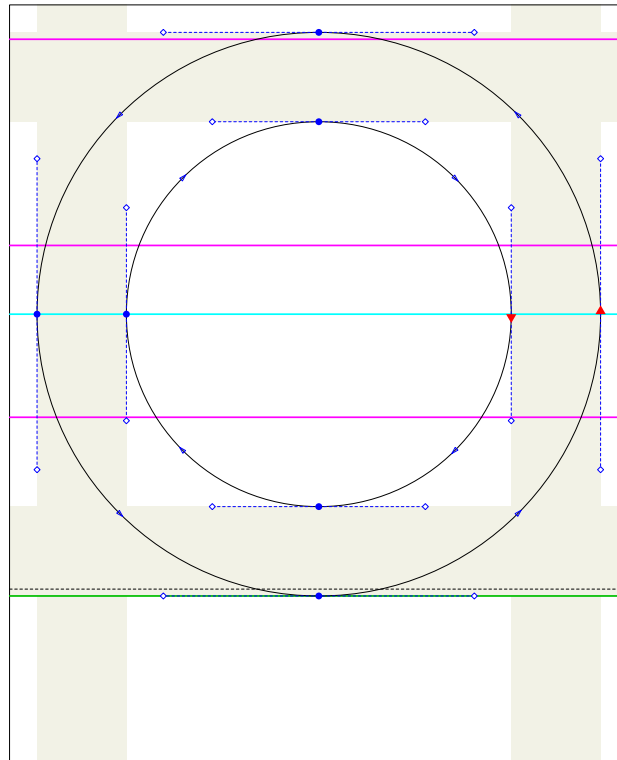

```

encode("Oacute")(211); standard_introduce("Oacute");
begin_glyph(Oacute);
use_accent(O, acute)(0, -o);
fix_dimens(wd.O, ht.O + ht.acute - lc.height - o, dp.O, 0);
standard_exact_hsbw("Oacute");
end_glyph;

```

Construction of the character Ocircumflex:

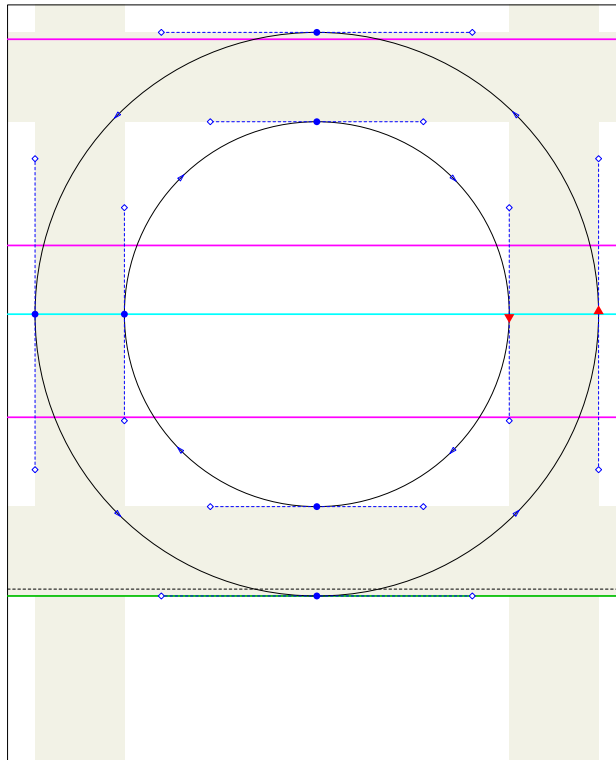

```

encode("Ocircumflex")(212); standard_introduce("Ocircumflex");
beginlyph(Ocircumflex);
use_accent(O, circumflex)(0, -o);
fix_dimens(wd.O, ht.O + ht.circumflex - lc.height - o, dp.O, 0);
standard_exact_hsbw("Ocircumflex");
endglyph;

```

Construction of the character Otilde:

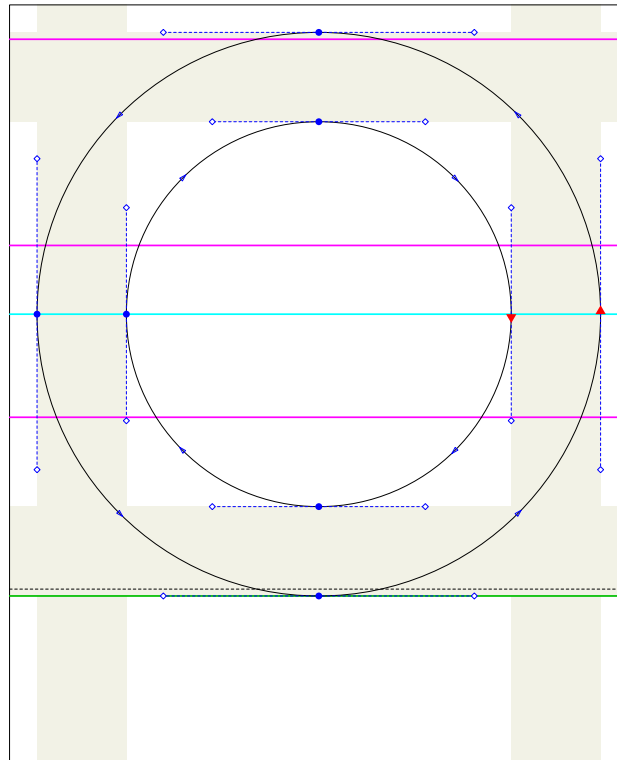

```

encode("Otilde")(213); standard_introduce("Otilde");
begin_glyph(Otilde);
use_accent(O, tilde)(0, -o);
fix_dimens(wd.O, ht.O + ht.tilde - lc_height - o, dp.O, 0);
standard_exact_hsbw("Otilde");
end_glyph;

```

Construction of the character Odieresis:

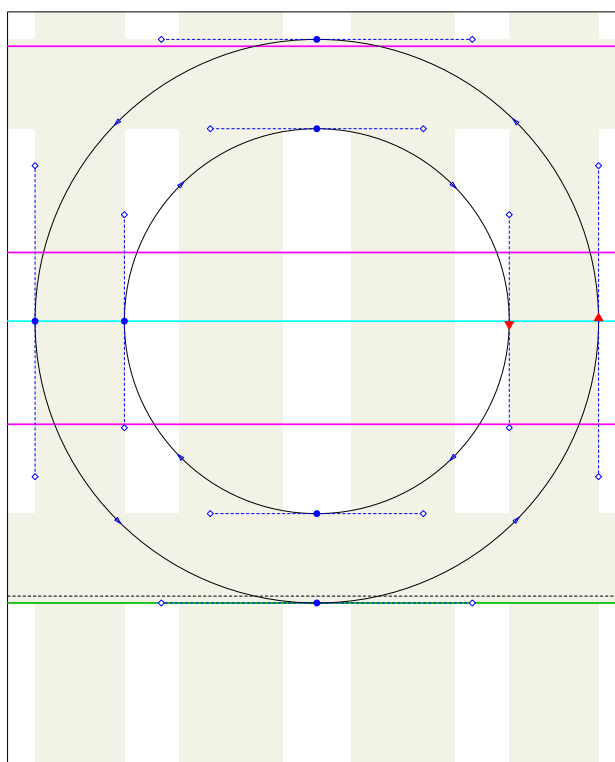

```

encode("Odieresis")(214); standard_introduce("Odieresis");
beginlyph(Odieresis);
use_accent(O, dieresis)(0, -o);
fix_dimens(wd.O, ht.O + ht.dieresis - lc.height - o, dp.O, 0);
standard_exact_hsbw("Odieresis");
endglyph;

```

Construction of the character multiply:

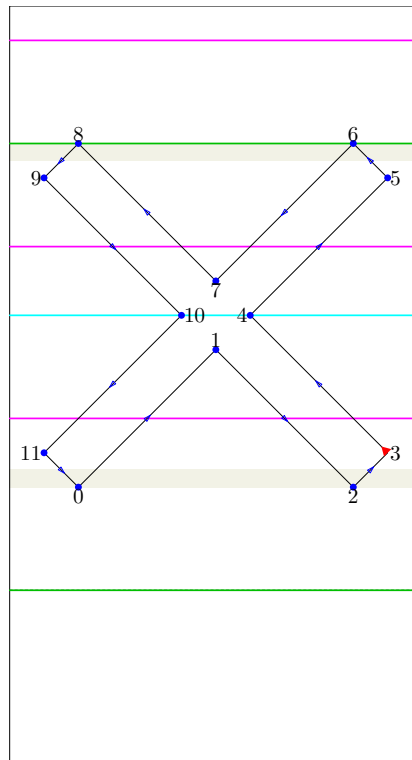

```
encode("multiply")(215); standard_introduce("multiply");
beginlyph(multiply);
```

```
 $y_0 = y_2 = \text{math\_axis} - 1.5py - 2xu$ ;  $x_9 = x_{11} = \text{leftstemloc}$ ;  $y_8 = y_6 = \text{math\_axis} + 1.5py + 2xu$ ;
```

```
 $x_0 - x_{11} = x_3 - x_2 = x_5 - x_6 = x_8 - x_9$ 
```

```
 $= y_{11} - y_0 = y_3 - y_2 = y_6 - y_5 = y_8 - y_9 = xu$ ;
```

```
 $x_6 - x_{11} = y_6 - y_{11}$ ;  $x_3 - x_8 = y_8 - y_3$ ;
```

```
 $z_{10} = \text{whatever}[z_{11}, z_6] = \text{whatever}[z_2, z_9]$ ;
```

```
 $z_1 = \text{whatever}[z_0, z_5] = \text{whatever}[z_2, z_9]$ ;
```

```
 $z_4 = \text{whatever}[z_0, z_5] = \text{whatever}[z_3, z_8]$ ;
```

```
 $z_7 = \text{whatever}[z_{11}, z_6] = \text{whatever}[z_3, z_8]$ ;
```

```
Fill  $z_0$  --  $z_1$  --  $z_2$  --  $z_3$  --  $z_4$  --  $z_5$  --  $z_6$  --  $z_7$  --  $z_8$  --  $z_9$  --  $z_{10}$  --  $z_{11}$  -- cycle;
```

```
ghost_stem top, bot;
```

```
fix_dimens( $x_3 + \text{rightbear}$ ,  $y_6$ , 0, 0);
```

```
just_labels bot(0, 2, 7);
```

```
just_labels rt(3, 5, 10);
```

```
just_labels top(1, 6, 8);
```

```
just_labels lft(4, 9, 11);
```

```
standard_exact_hsbw("multiply");
```

```
endglyph;
```

Construction of the character Oslash:

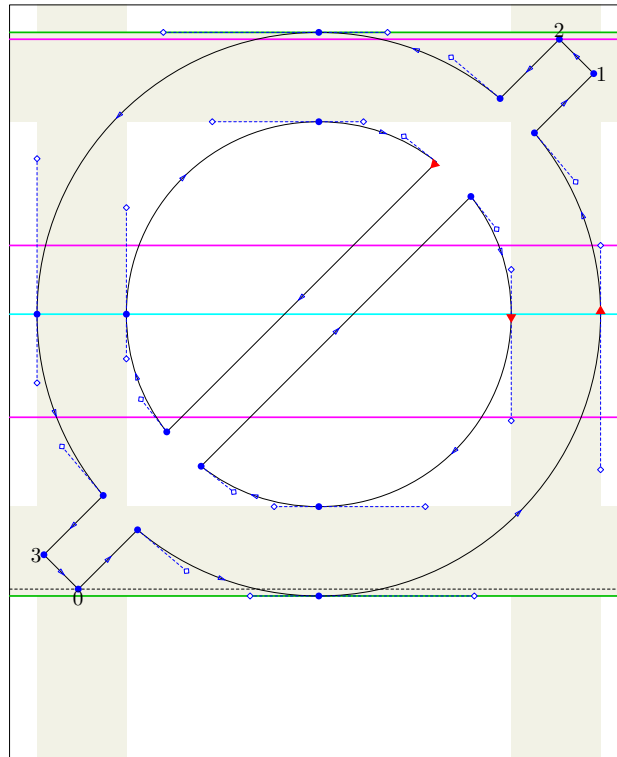

```

encode("Oslash")(216); standard_introduce("Oslash");
beginglyph(Oslash);
 $y_0 = 0$ ;  $x_3 = \text{leftstemloc}$ ;  $y_2 = \text{uc\_height}$ ;
 $x_0 - x_3 = x_1 - x_2 = y_3 - y_0 = y_2 - y_1 = xu$ ;
 $x_2 - x_3 = y_2 - y_3$ ;

find_outlines(glyph_stored.O 1,  $z_0$  --  $z_1$  --  $z_2$  --  $z_3$  -- cycle)(glypha);
find_outlines(reverse glyph_stored.O 2,  $z_0$  --  $z_3$  --  $z_2$  --  $z_1$  -- cycle)(glyphb);

Fill glypha1;
unFill reverse glyphb1, reverse glyphb2;

use_stems(O);
fix_dimens(wd.O, ht.O, dp.O, 0);

just_labels bot(0);
just_labels rt(1);
just_labels top(2);
just_labels lft(3);

standard_exact_hsbw("Oslash");
endglyph;

```

Construction of the character Ugrave:

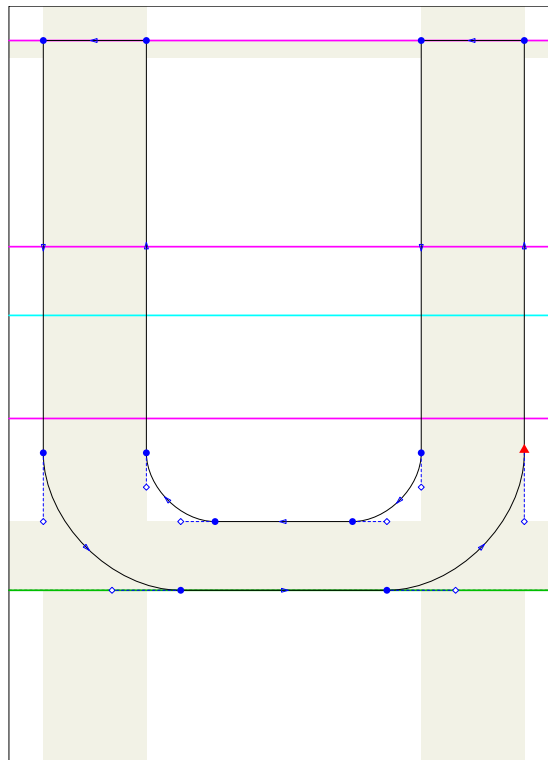

```

encode("Ugrave")(217); standard_introduce("Ugrave");
beginlyph(Ugrave);
use_accent(U, grave);

fix_dimens(wd.U, ht.U + ht.grave - lc.height, 0, 0);
standard_exact_hsbw("Ugrave");
endlyph;

```

Construction of the character Uacute:

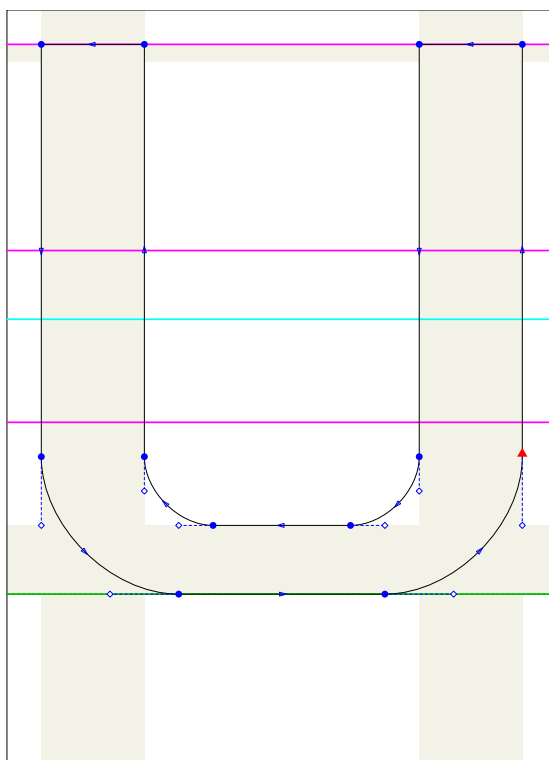

```

encode("Uacute")(218); standard_introduce("Uacute");
begin_glyph(Uacute);
use_accent(U, acute);

fix_dimens(wd.U, ht.U + ht.acute - lc.height, 0, 0);

standard_exact_hsbw("Uacute");
end_glyph;

```

Construction of the character Ucircumflex:

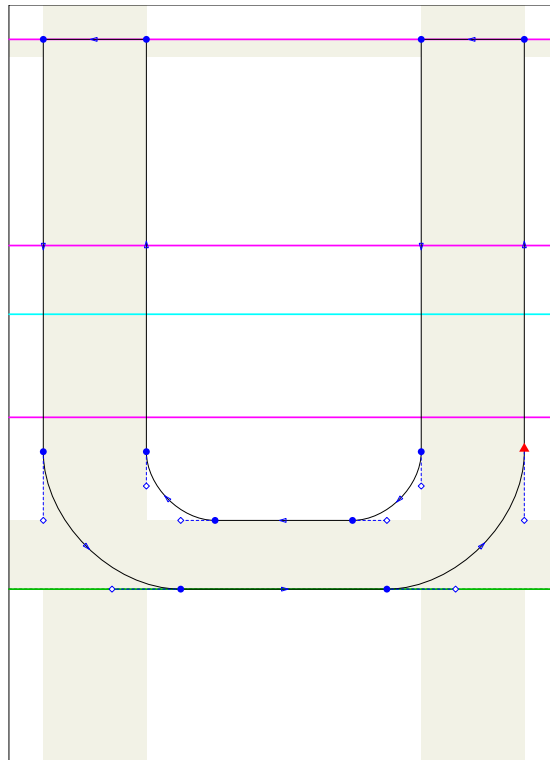

```

encode("Ucircumflex")(219); standard_introduce("Ucircumflex");
beginlyph(Ucircumflex);
use_accent(U, circumflex);

fix_dimens(wd.U, ht.U + ht.circumflex - lc.height, 0, 0);

standard_exact_hsbw("Ucircumflex");
endglyph;

```

Construction of the character Udieresis:

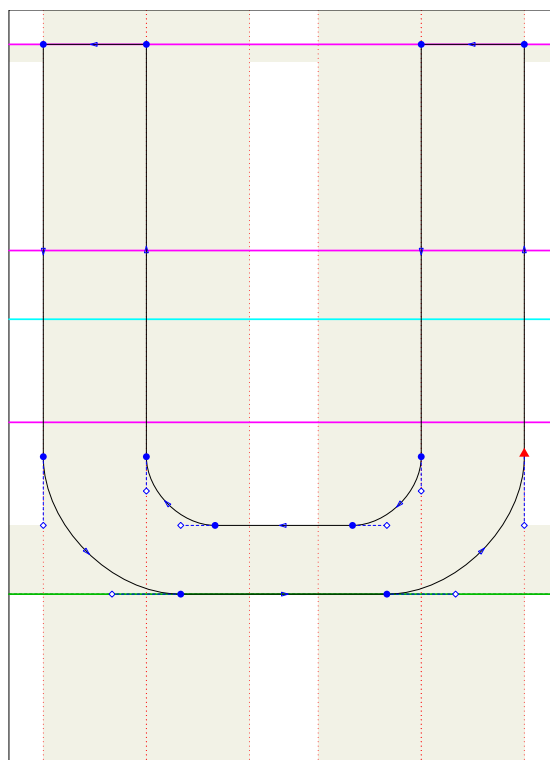

```

encode("Udieresis")(220); standard_introduce("Udieresis");
beginlyph(Udieresis);
use_accent(U, dieresis);

fix_dimens(wd.U, ht.U + ht.dieresis - lc.height, 0, 0);

standard_exact_hsbw("Udieresis");
endglyph;

```

Construction of the character Yacute:

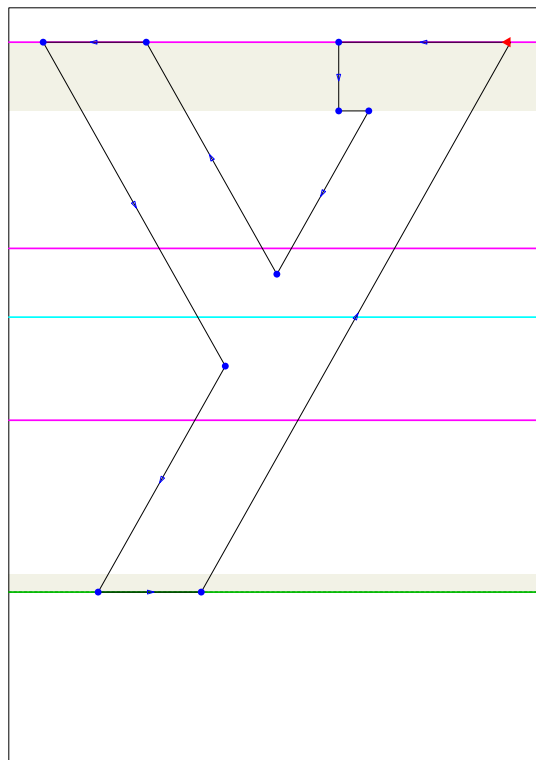

```

encode("Yacute")(221); standard_introduce("Yacute");
begin_glyph(Yacute);
use_accent(Y, acute);

fix_dimens(wd.Y, ht.Y + ht.acute - lc_height, 0, 0);

standard_exact_hsbw("Yacute");
end_glyph;

```

Construction of the character Thorn:

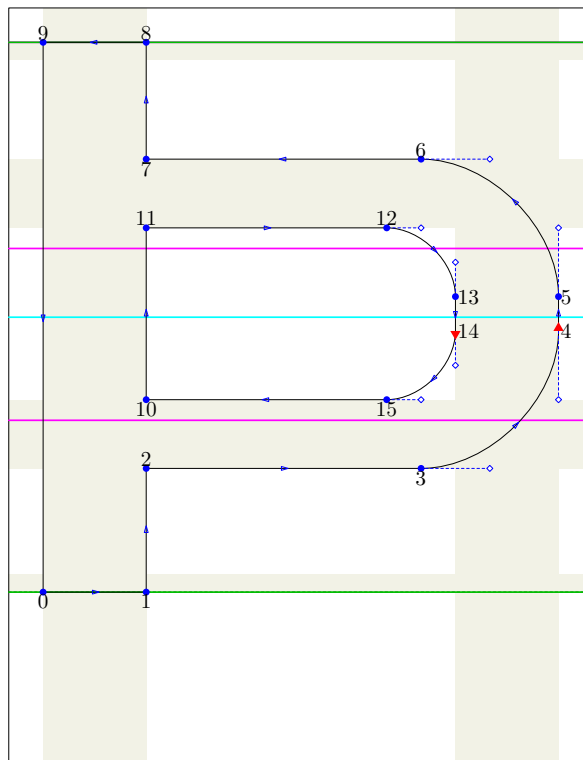

```

encode("Thorn")(222); standard_introduce("Thorn");
begin_glyph(Thorn);
 $y_0 = y_1 = 0$ ;  $x_0 = x_9 = \text{leftstemloc}$ ;  $y_8 = y_9 = \text{uc\_height}$ ;
 $x_1 - x_0 = x_2 - x_0 = x_{10} - x_0 = x_{11} - x_9 = x_7 - x_9$ 
 $= x_8 - x_9 = x_5 - x_{13} = x_4 - x_{14} = px$ ;  $x_{12} - x_{11} = x_{15} - x_{10} = 7xu$ ;
 $y_{10} - y_2 = y_{15} - y_3 = y_6 - y_{12} = y_7 - y_{11} = py$ ;
 $y_9 - y_7 = y_8 - y_6 = 3xu + 2u$ ;  $y_2 - y_0 = y_3 - y_1 = 3xu + 3u$ ;
 $z_4 = z_3 + (\text{obow}, \text{obow})$ ;  $z_6 = z_5 + (-\text{obow}, \text{obow})$ ;  $z_{13} = z_{12} + (\text{ibow}, -\text{ibow})$ ;
 $z_{15} = z_{14} - (\text{ibow}, \text{ibow})$ ;

Fill  $z_0$  --  $z_1$  --  $z_2$  -- crescent right(3, 4) -- crescent up(5, 6) --  $z_7$  --  $z_8$  --  $z_9$  -- cycle;
unFill  $z_{10}$  --  $z_{11}$  -- bow right(12, 13) -- bow down(14, 15) -- cycle;

fix_vstem( $px$ )(glyph_stored.glyph_name 1, glyph_stored.glyph_name 2);
fix_hstem( $py$ )(glyph_stored.glyph_name 1, glyph_stored.glyph_name 2);
ghost_stem bot, top;
fix_dimens( $x_4 + \text{rightbear}$ ,  $y_8$ , 0, 0);

just_labels bot(0, 1, 3, 7, 10, 15);
just_labels top(2, 6, 8, 9, 11, 12);
just_labels rt(4, 5, 13, 14);

standard_exact_hsbw("Thorn");
end_glyph;

```

Construction of the character germandbls:

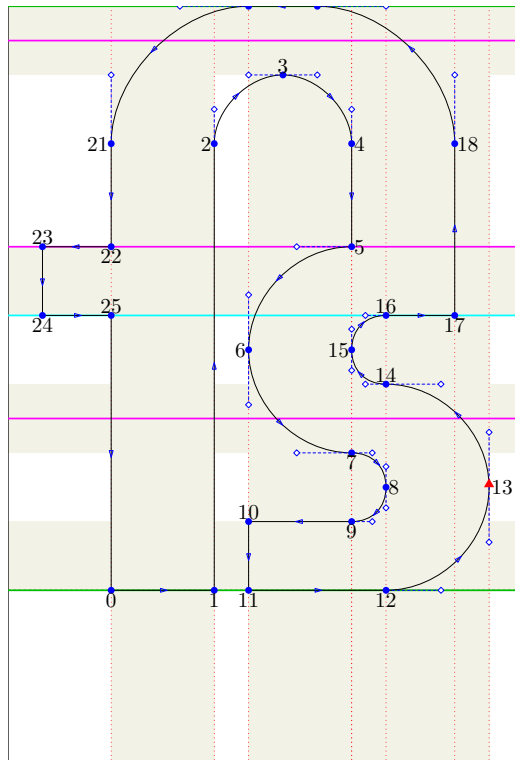

```

encode("germandbls")(223); standard_introduce("germandbls");
beginglyph(germandbls);
y0 = y1 = y11 = y12 = 0; x23 = x24 = leftstemloc; y19 = y20 = ascender;
x1 - x0 = x2 - x21 = x18 - x4 = x17 - x5 = x15 - x6 = x13 - x8 = px;
x21 = x22; x0 = x25; x22 - x23 = x25 - x24 = 2xu; x4 = x5;
x10 = x11 = x6; y16 = y17; y22 = y23 = lc_height;
y10 - y11 = y9 - y12 = y14 - y7 = y5 - y16 = y20 - y3
= y22 - y25 = y23 - y24 = py;
z3 = z2 + (ibow, ibow); z4 = z3 + (ibow, -ibow); z6 = z5 - (.75obow, .75obow);
z7 = z6 + (.75obow, -.75obow); z8 = z7 + (.5ibow, -.5ibow); z9 = z8 - (.5ibow, .5ibow);
z13 = z12 + (.75obow, .75obow); z14 = z13 + (-.75obow, .75obow);
z15 = z14 + (-.5ibow, .5ibow); z16 = z15 + (.5ibow, .5ibow); z19 = z18 + (-obow, obow);
z21 = z20 - (obow, obow); hh0 := y8; hh1 := y6;

Fill z0 -- z1 -- bow up(2, 3) & bow right(3, 4) -- small_crescent left(5, 6)
& small_crescent down(6, 7) & small_bow right(7, 8) & small_bow down(8, 9)
-- z10 -- z11 -- small_crescent right(12, 13) & small_crescent up(13, 14)
& small_bow left(14, 15) & small_bow up(15, 16) -- z17 -- crescent up(18, 19)
-- crescent left(20, 21) -- z22 -- z23 -- z24 -- z25 -- cycle;

fix_vstem(px)(glyph_stored.glyph_name 1);
fix_hstem(py)(glyph_stored.glyph_name 1)((y > hh1) or (y < hh0));
fix_hstem(py)(glyph_stored.glyph_name 1)((y > hh0) and (y < hh1));
fix_dimens(x13 + rightbear, y19, 0, 0);

just_labels bot(0, 1, 7, 9, 11, 12, 17, 22, 24);
just_labels top(3, 10, 14, 16, 19, 20, 23, 25);
just_labels rt(4, 5, 8, 13, 18);
just_labels lft(2, 6, 15, 21);

standard_exact_hsbw("germandbls");
endglyph;

```

Construction of the character szlig:

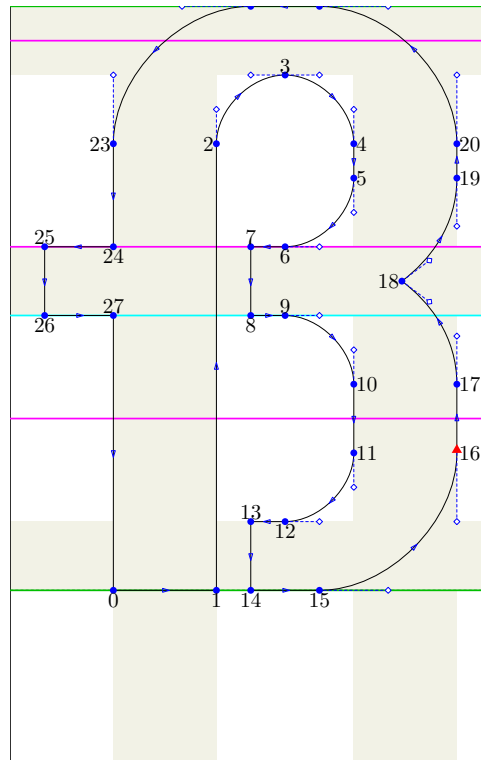

```
standard_introduce("szlig");
```

```
beginglyph(szlig);
```

```
 $y_0 = y_1 = y_{14} = y_{15} = 0$ ;  $x_{25} = x_{26} = \text{leftstemloc}$ ;  $y_{21} = y_{22} = \text{ascender}$ ;
```

```
 $x_1 - x_0 = x_2 - x_{23} = x_{20} - x_4 = x_{19} - x_5 = x_{17} - x_{10}$ 
```

```
 $= x_{16} - x_{11} = px$ ;  $y_{25} - y_{26} = y_{24} - y_{27} = y_{22} - y_3 = y_7 - y_8 = y_6 - y_9$ 
```

```
 $= y_{13} - y_{14} = y_{12} - y_{15} = py$ ;  $x_{24} - x_{25} = x_{27} - x_{26} = 2xu$ ;
```

```
 $x_6 - x_7 = x_9 - x_8 = x_{12} - x_{13} = xu$ ;  $y_6 = y_7 = y_{24} = y_{25} = \text{lc\_height}$ ;
```

```
 $y_{18} = .5[y_9, y_6]$ ;  $y_{19} - y_{18} = y_{18} - y_{17} = \text{obow} - .5py$ ;
```

```
 $x_{19} - x_{18} = x_{17} - x_{18} = .4\text{obow}$ ;  $x_{19} = x_{20} = x_{16}$ ;  $x_0 = x_{27}$ ;  $x_{23} = x_{24}$ ;  $x_{13} = x_{14}$ ;
```

```
 $z_3 = z_2 + (\text{ibow}, \text{ibow})$ ;  $z_4 = z_3 + (\text{ibow}, -\text{ibow})$ ;  $z_6 = z_5 - (\text{ibow}, \text{ibow})$ ;
```

```
 $z_{10} = z_9 + (\text{ibow}, -\text{ibow})$ ;  $z_{12} = z_{11} - (\text{ibow}, \text{ibow})$ ;  $z_{16} = z_{15} + (\text{obow}, \text{obow})$ ;
```

```
 $z_{21} = z_{20} + (-\text{obow}, \text{obow})$ ;  $z_{23} = z_{22} - (\text{obow}, \text{obow})$ ;
```

```
 $hv_0 := x_7$ ;
```

```
Fill  $z_0$  --  $z_1$  -- bow up(2, 3) & bow right(3, 4) -- bow down(5, 6) --  $z_7$  --  $z_8$ 
```

```
-- bow right(9, 10) -- bow down(11, 12) --  $z_{13}$  --  $z_{14}$  -- crescent right(15, 16)
```

```
-- bay up(17, 18) & bay right(18, 19) -- crescent up(20, 21) -- crescent left(22, 23)
```

```
--  $z_{24}$  --  $z_{25}$  --  $z_{26}$  --  $z_{27}$  -- cycle;
```

```
fix_vstem(px)(glyph_stored.glyph_name 1)( $x < hv_0$ );
```

```
fix_vstem(px)(glyph_stored.glyph_name 1)( $x > hv_0$ );
```

```
fix_hstem(py)(glyph_stored.glyph_name 1);
```

```
fix_dimens( $x_{16} + \text{rightbear}$ ,  $y_{21}$ , 0, 0);
```

```
just_labels bot(0, 1, 6, 8, 12, 14, 15, 24, 26);
```

```
just_labels top(3, 7, 9, 13, 21, 22, 25, 27);
```

```
just_labels rt(4, 5, 10, 11, 16, 17, 19, 20);
```

```
just_labels lft(2, 18, 23);
```

```
standard_exact_hsbw("szlig");
```

```
endglyph;
```

Construction of the character agrave:

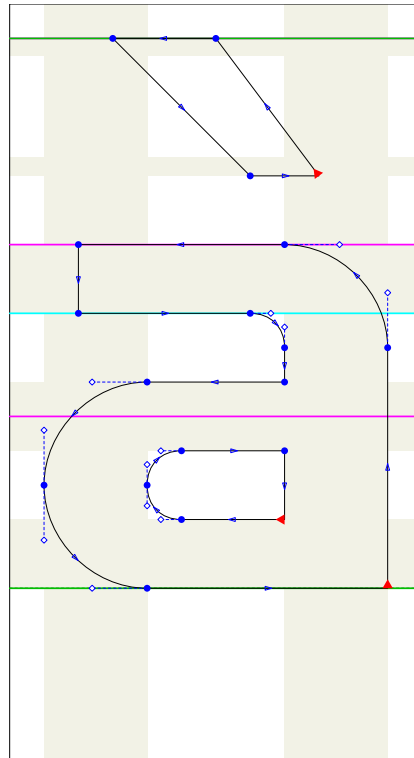

```

encode("agrave")(224); standard_introduce("agrave");
beginlyph(agrave);
use_accent(a, grave);

fix_dimens(wd.a, ht.grave, 0, 0);
standard_exact_hsbw("agrave");
endglyph;

```

Construction of the character `acute`:

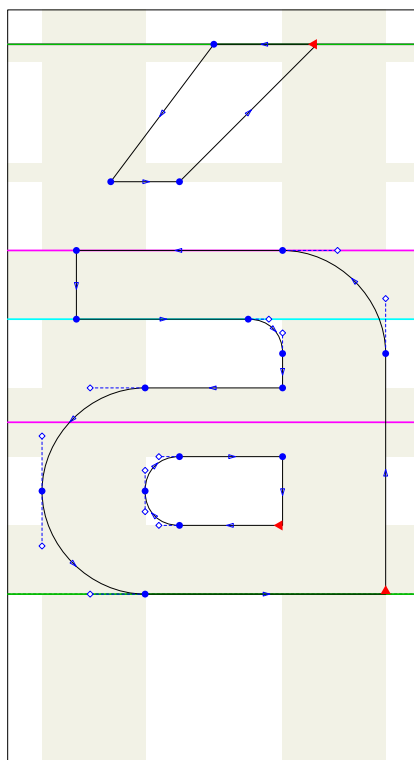

```

encode("acute")(225); standard_introduce("acute");
begin_glyph(acute);
use_accent(a, acute);

fix_dimens(wd.a, ht.acute, 0, 0);

standard_exact_hsbw("acute");
end_glyph;

```

Construction of the character acircumflex:

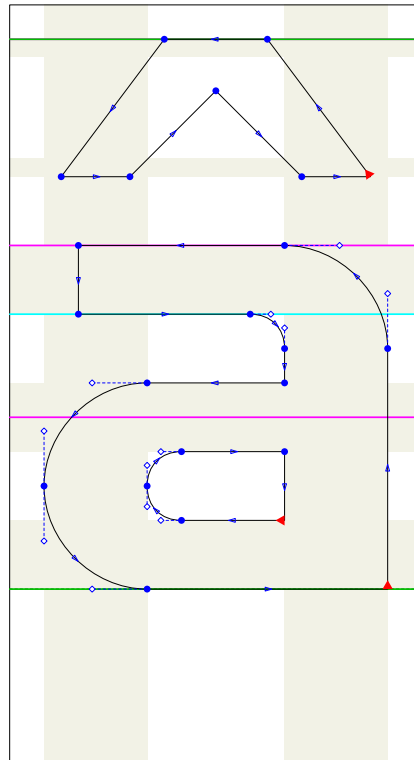

```

encode("acircumflex")(226); standard_introduce("acircumflex");
beginlyph(acircumflex);
use_accent(a, circumflex);

fix_dimens(wd.a, ht.acute, 0, 0);

standard_exact_hsbw("acircumflex");
endglyph;

```

Construction of the character atilde:

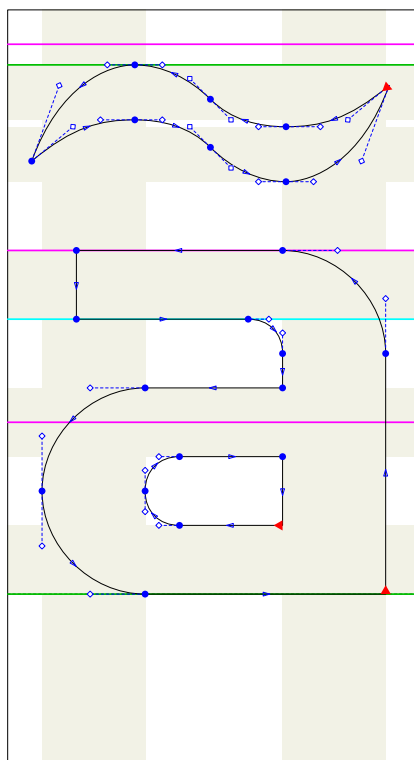

```
encode("atilde")(227); standard_introduce("atilde");
beginlyph(atilde);
use_accent(a, tilde);

fix_dimens(wd.a, ht.tilde, 0, 0);
standard_exact_hsbw("atilde");
endglyph;
```

Construction of the character adieresis:

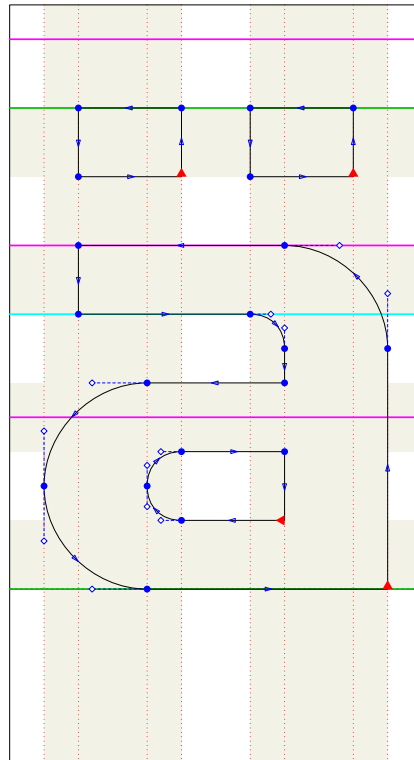

```

encode("adieresis")(228); standard_introduce("adieresis");
beginlyph(adieresis);
use_accent(a, dieresis);

fix_dimens(wd.a, ht.dieresis, 0, 0);

standard_exact_hsbw("adieresis");
endglyph;

```

Construction of the character aring:

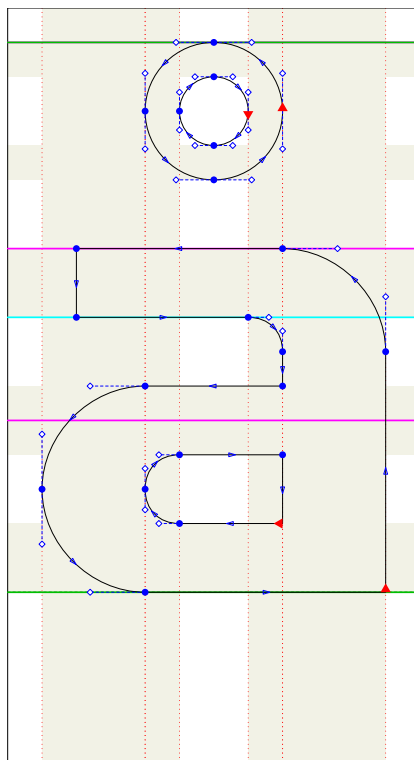

```

encode("aring")(229); standard_introduce("aring");
beginlyph(aring);
use_accent(a, ring);

fix_dimens(wd.a, ht.ring, 0, 0);
standard_exact_hsbw("aring");
endglyph;

```

Construction of the character ae:

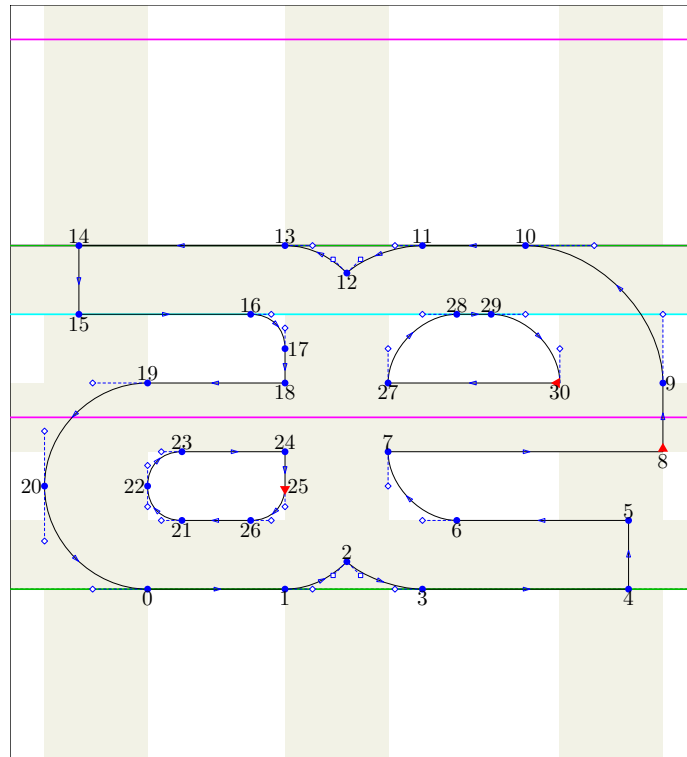

```
encode("ae")(230); standard_introduce("ae");
beginlyph(ae);
```

$$y_0 = y_1 = y_3 = y_4 = 0; \quad x_{20} = \text{leftstemloc}; \quad y_{10} = y_{11} = y_{13} = y_{14} = \text{lc_height};$$

$$x_{22} - x_{20} = x_7 - x_{24} = x_7 - x_{25} = x_{27} - x_{18}$$

$$= x_{27} - x_{17} = x_9 - x_{30} = px;$$

$$x_{18} = x_{24}; \quad x_{14} = x_{15} = x_{20} + xu;$$

$$x_{26} - x_{21} = 2xu; \quad x_{12} - x_{13} = x_2 - x_1 = 2xu - u;$$

$$y_{13} - y_{12} = y_2 - y_1 = xu - u;$$

$$y_{14} - y_{15} = y_{13} - y_{16} = y_{21} - y_0 = y_{26} - y_1$$

$$= y_{11} - y_{28} = y_{10} - y_{29} = y_6 - y_3 = y_5 - y_4$$

$$= y_{18} - y_{24} = py;$$

$$y_8 = y_7; \quad y_{24} = y_{23}; \quad x_3 - x_{25} = x_{11} - x_{17} = obow;$$

$$x_{27} - x_{13} = x_7 - x_1 = .75obow; \quad x_4 = x_5; \quad x_8 - x_5 = xu; \quad x_{29} - x_{28} = xu; \quad x_8 = x_9;$$

$$z_7 = z_6 + (-ibow, ibow); \quad z_{10} = z_9 + (-obow, obow);$$

$$z_{17} = z_{16} + (.5ibow, -.5ibow); \quad z_{20} = z_{19} - (.75obow, .75obow);$$

$$z_0 = z_{20} + (.75obow, -.75obow); \quad z_{22} = z_{21} + (-.5ibow, .5ibow);$$

$$z_{23} = z_{22} + (.5ibow, .5ibow); \quad z_{26} = z_{25} - (.5ibow, .5ibow);$$

$$z_{28} = z_{27} + (ibow, ibow); \quad z_{30} = z_{29} + (ibow, -ibow);$$

$$hh_0 := y_{21}; \quad hh_1 := y_{24}; \quad hh_2 := y_{18}; \quad hh_3 := y_{16};$$

```

Fill  $z_0$  --  $z_1$  .. controls( $x_1 + xu - u, y_1$ ) and ( $x_2 - 2u, y_2 - 2u$ ) ..  $z_2$ 
.. controls( $x_2 + 2u, y_2 - 2u$ ) and ( $x_3 - xu + u, y_3$ ) ..  $z_3$  --  $z_4$  --  $z_5$ 
-- bow left(6, 7) --  $z_8$  -- crecident up(9, 10)
--  $z_{11}$  .. controls( $x_{11} - xu + u, y_{11}$ ) and ( $x_{12} + 2u, y_{12} + 2u$ ) ..  $z_{12}$ 
.. controls( $x_{12} - 2u, y_{12} + 2u$ ) and ( $x_{13} + xu - u, y_{13}$ ) ..  $z_{13}$  --  $z_{14}$  --  $z_{15}$ 
-- small_bow right(16, 17) --  $z_{18}$  -- small_crescent left(19, 20)
& small_crescent down(20, 0) & cycle;
unFill small_bow left(21, 22) & small_bow up(22, 23) --  $z_{24}$ 
-- small_bow down(25, 26) -- cycle,
bow up(27, 28) -- bow right(29, 30) -- cycle;

fix_vstem( $px$ )(glyph_stored.glyph_name 1, glyph_stored.glyph_name 2,
glyph_stored.glyph_name 3);
fix_hstem( $py$ )(glyph_stored.glyph_name 1, glyph_stored.glyph_name 2,
glyph_stored.glyph_name 3)(( $y \leq hh_0$ ) or ( $y \geq hh_3$ ));
fix_hstem( $py$ )(glyph_stored.glyph_name 1, glyph_stored.glyph_name 2,
glyph_stored.glyph_name 3)(( $y \geq hh_1$ ) and ( $y \leq hh_2$ ));
fix_dimens( $x_8 + rightbear, y_{10}, 0, 0$ );

just_labels bot(0, 1, 3, 4, 6, 8, 12, 15, 18, 21, 26, 27, 30);
just_labels top(2, 5, 7, 10, 11, 13, 14, 16, 19, 23, 24, 28, 29);
just_labels lft(20, 22);
just_labels rt(9, 17, 25);

standard_exact_hsbw("ae");
endglyph;

```

Construction of the character ccedilla:

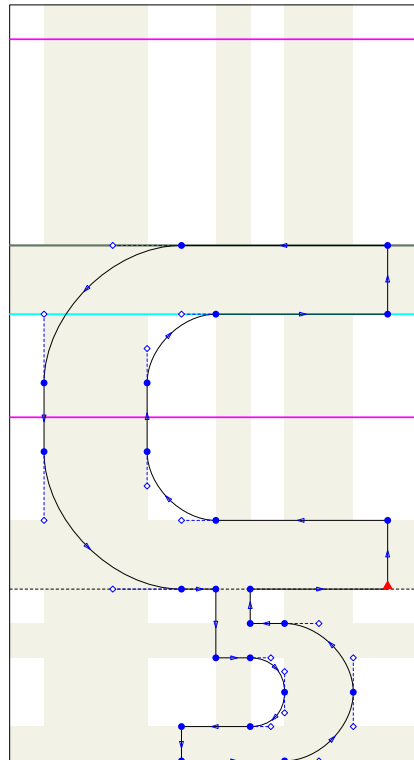

```

encode("ccedilla")(231); standard_introduce("ccedilla");
beginglyph(ccedilla);
find_outlines(glyph_stored.c 1, glyph_stored.cedilla 1
  shifted (4xu, 0))(glyph);
Fill glyph1;
use_stems(c);
use_stems(cedilla)(4xu, 0);
fix_dimens(wd.c, ht.c, dp.cedilla, 0);
standard_exact_hsbw("ccedilla");
endglyph;

```

Construction of the character egrave:

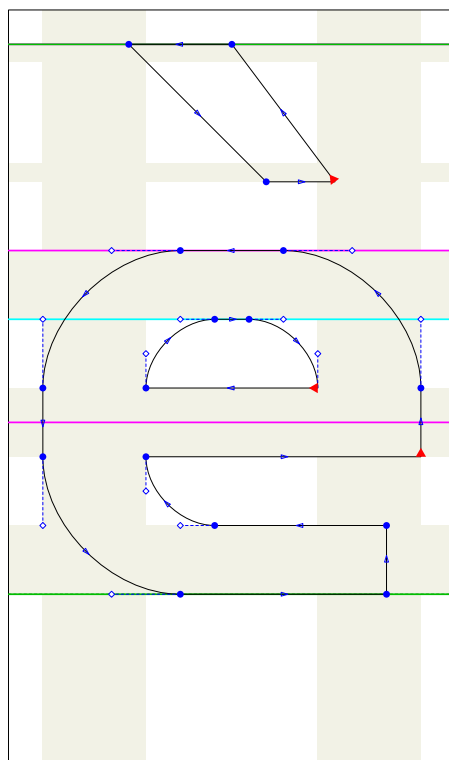

```

encode("egrave")(232); standard_introduce("egrave");
beginglyph(egrave);
use_accent(e, grave);

fix_dimens(wd.e, ht.grave, 0, 0);
standard_exact_hsbw("egrave");
endglyph;

```

Construction of the character eacute:

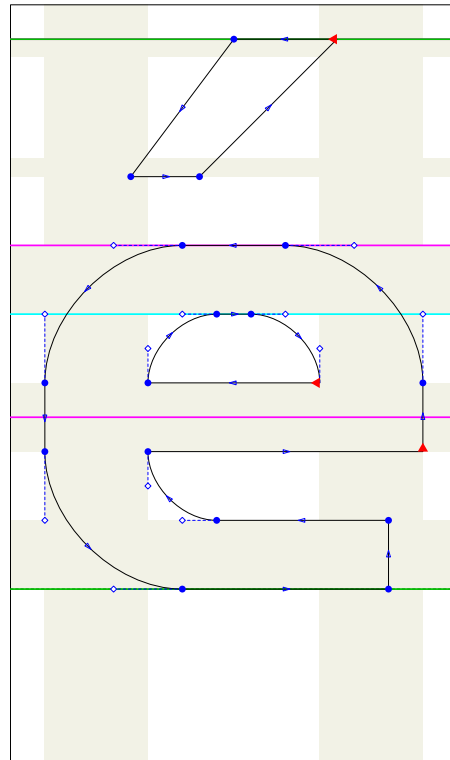

```

encode("eacute")(233); standard_introduce("eacute");
beginglyph(eacute);
use_accent(e, acute);
fix_dimens(wd.e, ht.acute, 0, 0);
standard_exact_hsbw("eacute");
endglyph;

```

Construction of the character ecircumflex:

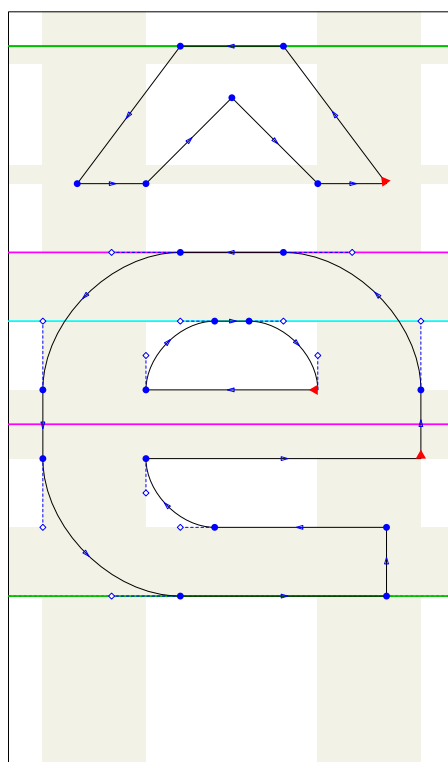

```

encode("ecircumflex")(234); standard_introduce("ecircumflex");
beginlyph(ecircumflex);
use_accent(e, circumflex);

fix_dimens(wd.e, ht.circumflex, 0, 0);

standard_exact_hsbw("ecircumflex");
endglyph;

```

Construction of the character edieresis:

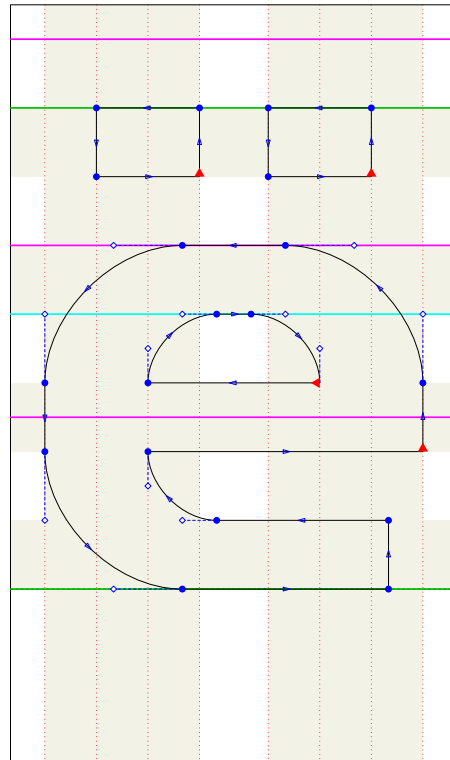

```

encode("edieresis")(235); standard_introduce("edieresis");
beginlyph(edieresis);
use_accent(e, dieresis);

fix_dimens(wd.e, ht.dieresis, 0, 0);

standard_exact_hsbw("edieresis");
endglyph;

```

Construction of the character igrave:

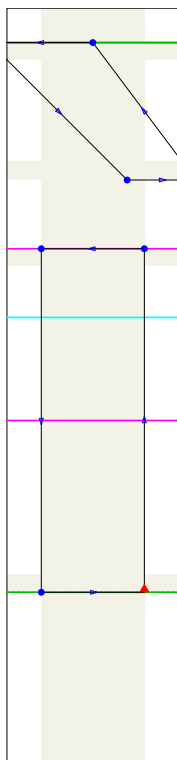

```
encode("igrave")(236); standard_introduce("igrave");
beginlyph(igrave);
use_accent(dotlessi, grave);

fix_dimens(wd.dotlessi, ht.grave, 0, 0);
standard_exact_hsbw("igrave");
endglyph;
```

Construction of the character iacute:

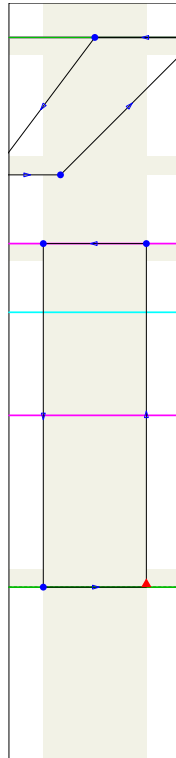

```
encode("iacute")(237); standard_introduce("iacute");
beginlyph(iacute);
use_accent(dotlessi, acute);
fix_dimens(wd.dotlessi, ht.acute, 0, 0);
standard_exact_hsbw("iacute");
endglyph;
```

Construction of the character `icircumflex`:

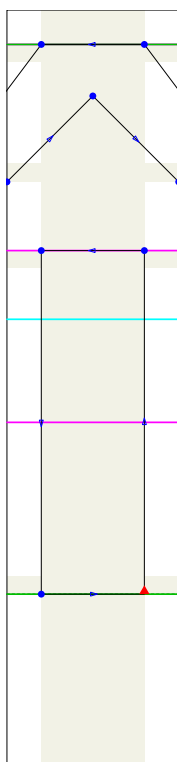

```

encode("icircumflex")(238); standard_introduce("icircumflex");
begin_glyph(icircumflex);
use_accent(dotlessi, circumflex);
fix_dimens(wd.dotlessi, ht.circumflex, 0, 0);
standard_exact_hsbw("icircumflex");
end_glyph;

```

Construction of the character idieresis:

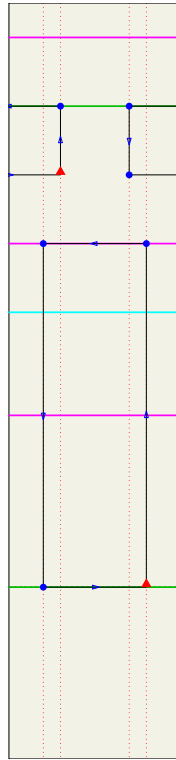

```

encode("idieresis")(239); standard_introduce("idieresis");
beginglyph(idieresis);
use_accent(dotlessi, dieresis);

fix_dimens(wd.dotlessi, ht.dieresis, 0, 0);
standard_exact_hsbw("idieresis");
endglyph;

```

Construction of the character eth:

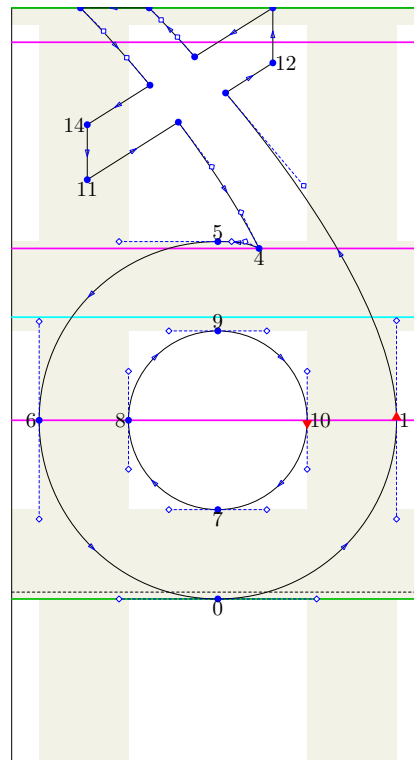

```

encode("eth")(240); standard_introduce("eth");
beginglyph(eth);
 $y_0 = -o$ ;  $x_6 = \text{leftstemloc} - o$ ;  $y_5 = \text{lc\_height} + o$ ;  $y_{13} = y_2 = y_3 = \text{ascender}$ ;
 $y_5 - y_9 = y_7 - y_0 = x_8 - x_6 = x_1 - x_{10} = o + .48(py + px)$ ;
 $x_1 - x_6 = y_5 - y_0$ ;  $x_5 = x_9 = x_7 = x_0 = .5[x_6, x_1]$ ;  $x_2 - x_3 = 2xu$ ;  $x_3 - x_6 = xu + o$ ;
 $y_6 = y_8 = y_{10} = y_1 = .5[y_0, y_5]$ ;  $x_{14} - x_3 = x_{11} - x_3 = u$ ;
 $x_{13} - x_2 = x_{12} - x_2 = 3xu + 3u$ ;  $y_{13} - y_{12} = y_{14} - y_{11} = xu + 3u$ ;  $y_{12} - y_{14} = 2xu - u$ ;
 $y_4 = \text{lc\_height}$ ;  $x_4 - x_5 = xu + u$ ;

find_outlines( $z_0 \dots z_1 \dots \text{controls}(x_1, y_1 + 4xu)$  and  $(x_2 + 2xu, y_2 - 2xu) \dots z_2$ 
  --  $z_3 \dots \text{controls}(x_3 + 2xu, y_3 - 2xu)$  and  $(x_4 - xu, y_4 + 2xu)$ 
  ..  $z_4 \dots \text{controls}(x_4 - 2u, y_4 + u)$  and  $(x_5 + 2u, y_5) \dots z_5 \dots z_6 \dots \text{cycle}$ ,
   $z_{11}$  --  $z_{12}$  --  $z_{13}$  --  $z_{14}$  -- cycle)(glyph);
Fill glyph1;
unFill  $z_7 \dots z_8 \dots z_9 \dots z_{10} \dots \text{cycle}$ ;

fix_vstem( $o + .48(py + px)$ )(glyph_stored.glyph_name 1, glyph_stored.glyph_name 2);
fix_hstem( $o + .48(py + px)$ )(glyph_stored.glyph_name 1, glyph_stored.glyph_name 2);
fix_dims( $x_1 + \text{rightbear} - o, y_2, y_0, 0$ );
ghost_stem top;

just_labels bot(0, 4, 7, 11);
just_labels top(2, 3, 5, 9, 13);
just_labels rt(1, 10, 12);
just_labels lft(6, 8, 14);

standard_exact_hsbw("eth");
endglyph;

```

Construction of the character ntilde:

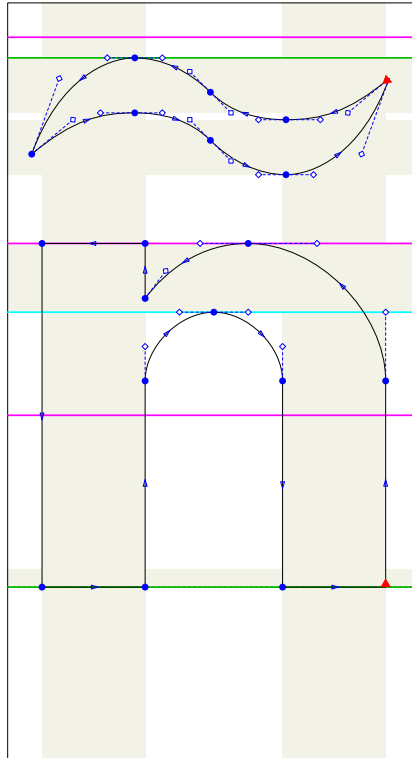

```

encode("ntilde")(241); standard_introduce("ntilde");
begin_glyph(ntilde);
use_accent(n, tilde);

fix_dimens(wd.n, ht.tilde, 0, 0);

standard_exact_hsbw("ntilde");
end_glyph;

```

Construction of the character ograve:

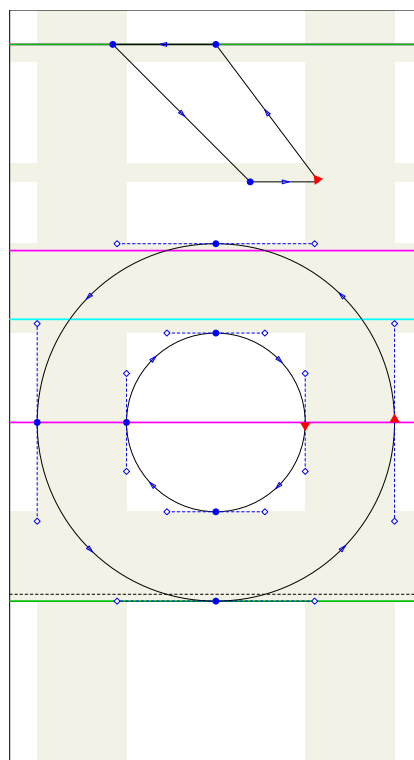

```

encode("ograve")(242); standard_introduce("ograve");
beginlyph(ograve);
  use_accent(o, grave)(0, -o);
fix_dimens(wd.o, ht.grave, dp.o, 0);
standard_exact_hsbw("ograve");
endglyph;

```

Construction of the character oacute:

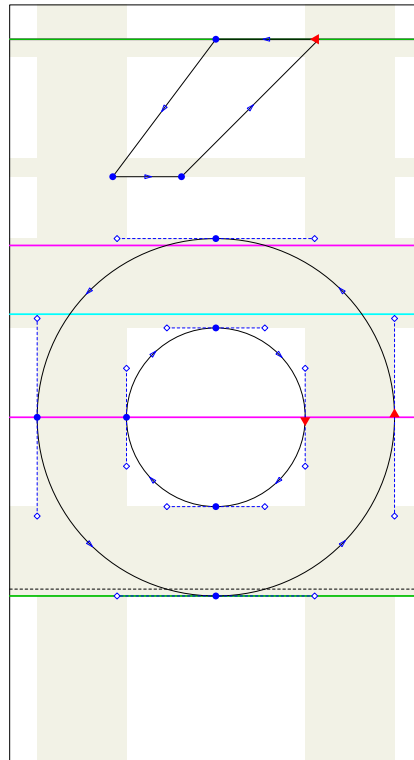

```

encode("oacute")(243); standard_introduce("oacute");
begin_glyph(oacute);
use_accent(o, acute)(0, -o);
fix_dimens(wd.o, ht.acute, dp.o, 0);
standard_exact_hsbw("oacute");
end_glyph;

```

Construction of the character ocircumflex:

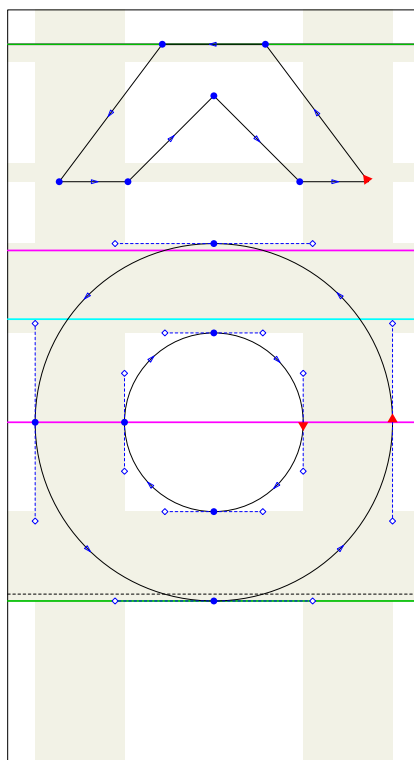

```

encode("ocircumflex")(244); standard_introduce("ocircumflex");
beginlyph(ocircumflex);
use_accent(o, circumflex)(0, -o);
fix_dimens(wd.o, ht.circumflex, dp.o, 0);
standard_exact_hsbw("ocircumflex");
endglyph;

```

Construction of the character otilde:

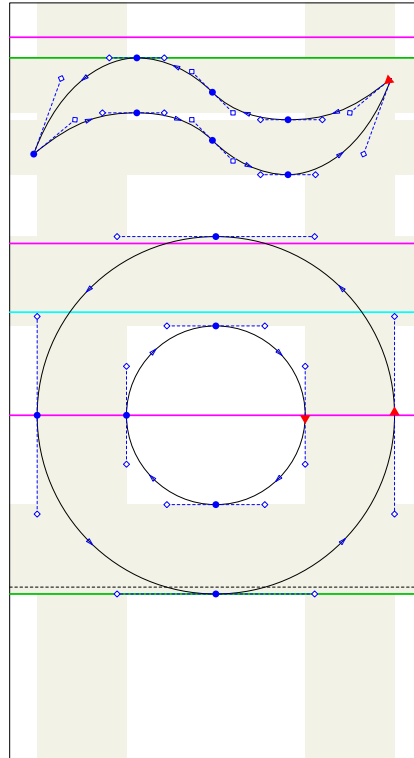

```

encode("otilde")(245); standard_introduce("otilde");
begin_glyph(otilde);
use_accent(o, tilde)(0, -o);
fix_dimens(wd.o, ht.tilde, dp.o, 0);
standard_exact_hsbw("otilde");
end_glyph;

```

Construction of the character odieresis:

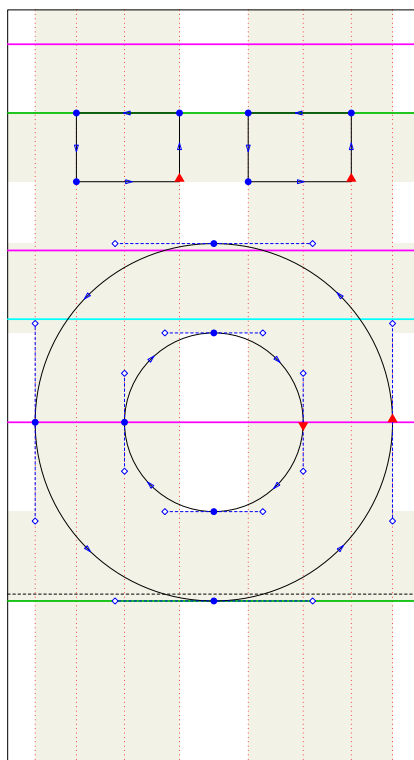

```

encode("odieresis")(246); standard_introduce("odieresis");
beginglyph(odieresis);
use_accent(o, dieresis)(0, -o);
fix_dimens(wd.o, ht.dieresis, dp.o, 0);
standard_exact_hsbw("odieresis");
endglyph;

```

Construction of the character divide:

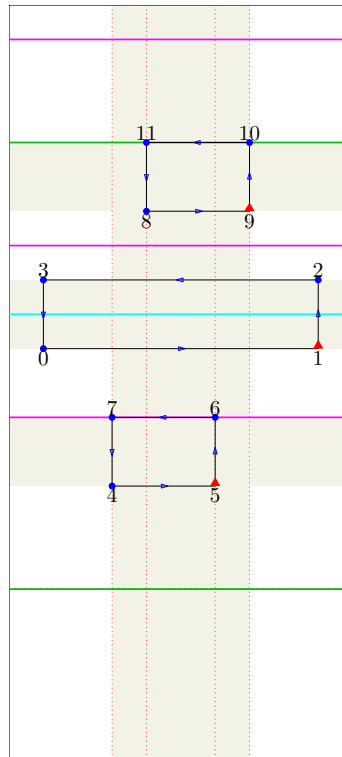

```

encode("divide")(247); standard_introduce("divide");
beginlyph(divide);
 $y_4 = y_5 = \text{math\_axis} - 1.5py - 2xu$ ;  $x_0 = x_3 = \text{leftstemloc}$ ;  $y_{10} = y_{11} = \text{math\_axis} + 1.5py + 2xu$ ;
 $.5[y_0, y_3] = .5[y_1, y_2] = \text{math\_axis}$ ;
 $x_{10} - x_{11} = x_9 - x_8 = x_6 - x_7 = x_5 - x_4 = px$ ;
 $x_2 - x_{10} = x_1 - x_9 = x_7 - x_3 = x_4 - x_0 = 2xu$ ;
 $y_3 - y_0 = y_2 - y_1 = y_7 - y_4 = y_6 - y_5$ 
 $= y_{10} - y_9 = y_{11} - y_8 = py$ ;
 $x_2 - x_3 = x_1 - x_0 = 2 * 3xu + py$ ; % Length (be equal to plus)

Fill  $z_0$  --  $z_1$  --  $z_2$  --  $z_3$  -- cycle,  $z_4$  --  $z_5$  --  $z_6$  --  $z_7$  -- cycle,
 $z_8$  --  $z_9$  --  $z_{10}$  --  $z_{11}$  -- cycle;

fix_vstem( $px$ )(glyph_stored.glyph_name 2, glyph_stored.glyph_name 3);
fix_hstem( $py$ )(glyph_stored.glyph_name 1);
fix_hstem( $py$ )(glyph_stored.glyph_name 2, glyph_stored.glyph_name 3);
fix_dimens( $x_1 + \text{rightbear}$ ,  $y_{10}$ , 0, 0);

just_labels bot(0, 1, 4, 5, 8, 9);
just_labels top(2, 3, 6, 7, 10, 11);

hstem_triple := true;

standard_exact_hsbw("divide");
endglyph;

```

Construction of the character oslash:

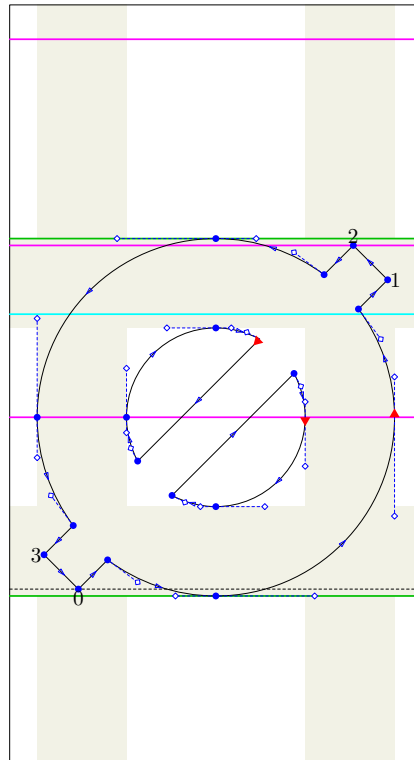

```

encode("oslash")(248); standard_introduce("oslash");
begin_glyph(oslash);
y0 = 0; x3 = leftstemloc; y2 = lc_height;
x0 - x3 = x1 - x2 = y3 - y0 = y2 - y1 = xu;
x2 - x3 = y2 - y3;

find_outlines(glyph_stored.o 1, z0 -- z1 -- z2 -- z3 -- cycle)(glypha);
find_outlines(reverse glyph_stored.o 2, z0 -- z3 -- z2 -- z1 -- cycle)(glyphb);

Fill glypha1;
unFill reverse glyphb1, reverse glyphb2;

use_stems(o);
fix_dimens(wd.o, ht.o, dp.o, 0);

just_labels bot(0);
just_labels rt(1);
just_labels top(2);
just_labels lft(3);

standard_exact_hsbw("oslash");
end_glyph;

```

Construction of the character ugrave:

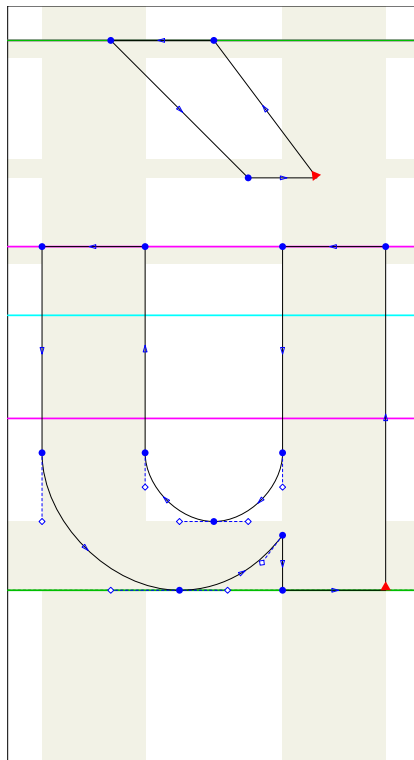

```
encode("ugrave")(249); standard_introduce("ugrave");
beginlyph(ugrave);
use_accent(u, grave);

fix_dimens(wd.u, ht.grave, 0, 0);
standard_exact_hsbw("ugrave");
endglyph;
```

Construction of the character uacute:

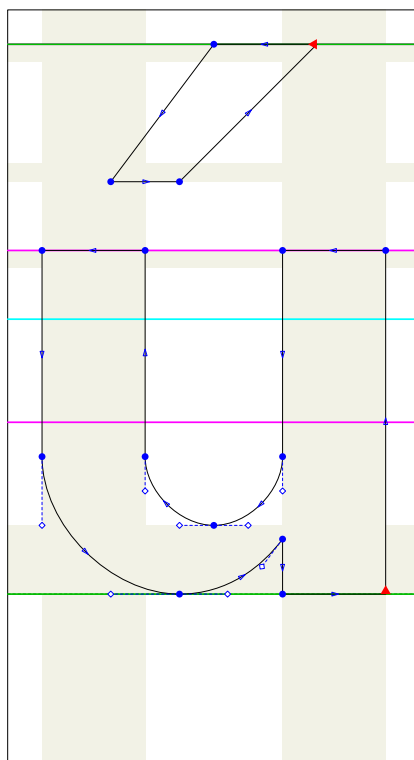

```

encode("uacute")(250); standard_introduce("uacute");
beginglyph(uacute);
use_accent(u, acute);
fix_dimens(wd.u, ht.acute, 0, 0);
standard_exact_hsbw("uacute");
endglyph;

```

Construction of the character ucircumflex:

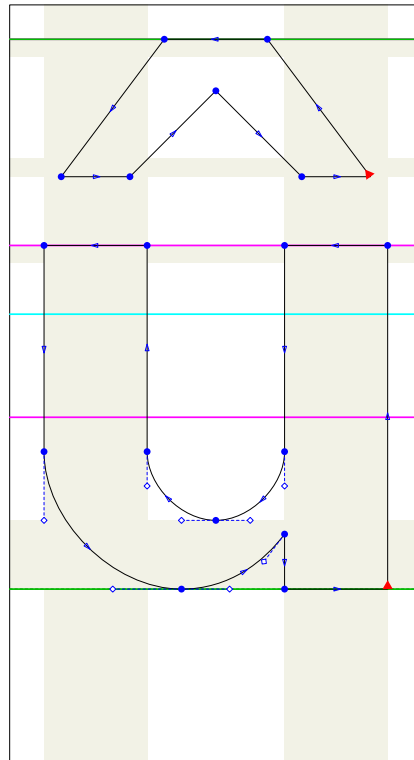

```

encode("ucircumflex")(251); standard_introduce("ucircumflex");
beginlyph(ucircumflex);
use_accent(u, circumflex);
fix_dimens(wd.u, ht.circumflex, 0, 0);
standard_exact_hsbw("ucircumflex");
endglyph;

```

Construction of the character udieresis:

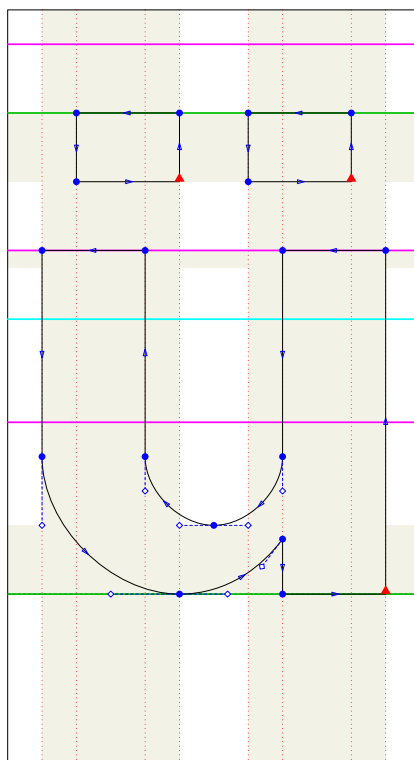

```

encode("udieresis")(252); standard_introduce("udieresis");
beginlyph(udieresis);
use_accent(u, dieresis);
fix_dimens(wd.u, ht.dieresis, 0, 0);
standard_exact_hsbw("udieresis");
endglyph;

```

Construction of the character yacute:

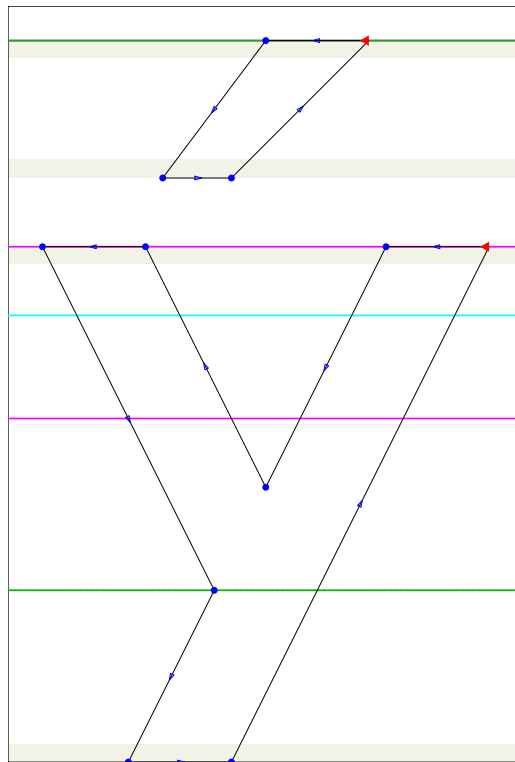

```

encode("yacute")(253); standard_introduce("yacute");
begin_glyph(yacute);
use_accent(y, acute);

fix_dimens(wd.y, ht.acute, 0, 0);
standard_exact_hsbw("yacute");
end_glyph;

```

Construction of the character thorn:

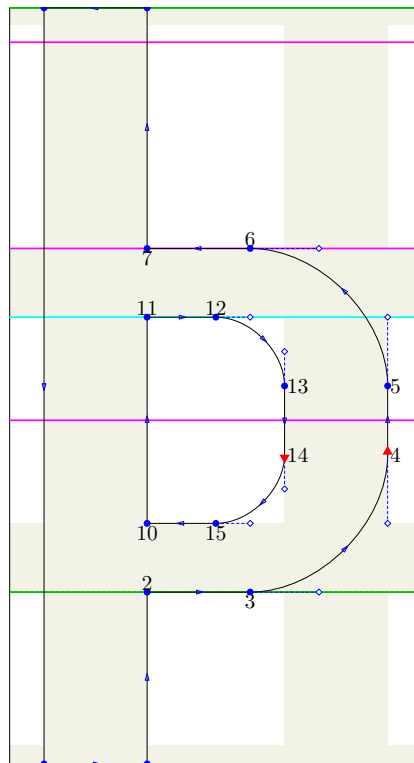

```

encode("thorn")(254); standard_introduce("thorn");
begin_glyph(thorn);
 $y_2 = y_3 = 0$ ;  $x_0 = x_9 = \text{leftstemloc}$ ;  $y_8 = y_9 = \text{ascender}$ ;
 $x_1 - x_0 = x_2 - x_0 = x_{10} - x_0 = x_{11} - x_9 = x_7 - x_9$ 
 $= x_8 - x_9 = x_5 - x_{13} = x_4 - x_{14} = px$ ;  $x_{15} - x_{10} = x_{12} - x_{11} = 2xu$ ;
 $y_{10} - y_2 = y_{15} - y_3 = y_7 - y_{11} = y_6 - y_{12} = py$ ;
 $y_7 = y_6 = \text{lc\_height}$ ;  $y_0 = y_1 = \text{descender}$ ;
 $z_4 = z_3 + (\text{obow}, \text{obow})$ ;  $z_6 = z_5 + (-\text{obow}, \text{obow})$ ;  $z_{13} = z_{12} + (\text{ibow}, -\text{ibow})$ ;
 $z_{15} = z_{14} - (\text{ibow}, \text{ibow})$ ;

Fill  $z_0$  --  $z_1$  --  $z_2$  -- crescent right(3, 4) -- crescent up(5, 6) --  $z_7$  --  $z_8$  --  $z_9$  -- cycle;
unFill  $z_{10}$  --  $z_{11}$  -- bow right(12, 13) -- bow down(14, 15) -- cycle;

fix_vstem( $px$ )(glyph_stored.glyph_name 1, glyph_stored.glyph_name 2);
fix_hstem( $py$ )(glyph_stored.glyph_name 1, glyph_stored.glyph_name 2);
ghost_stem bot, top;
fix_dimens( $x_4 + \text{rightbear}$ ,  $y_8$ , 0, 0);

just_labels bot(0, 1, 3, 7, 10, 15);
just_labels top(2, 6, 8, 9, 11, 12);
just_labels rt(4, 5, 13, 14);

standard_exact_hsbw("thorn");
end_glyph;

```

Construction of the character ydieresis:

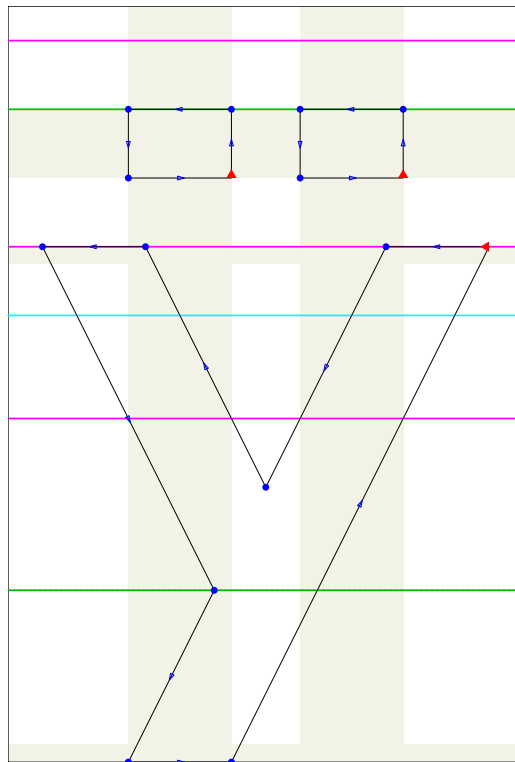

```

encode("ydieresis")(255); standard_introduce("ydieresis");
beginlyph(ydieresis);
use_accent(y, dieresis);

fix_dimens(wd.y, ht.dieresis, 0, 0);
standard_exact_hsbw("ydieresis");
endglyph;

```

LIGATURE/KERNING TABLE

This is the ligature/kerning table which describes some correction of horizontal spacing and ligatures for pairs of letters. That greatly removes annoying effects which occur where the extremes are not at the same height, as for example in ‘AV’ and if features touch, as in ‘fi.’

```

LK("slash") KP("A", "Agrave", "Aacute", "Acircumflex", "Atilde", "Adieresis",
  "Aring", "J", "slash")(-2leftstemloc - px - o - u) KL;
LK("backslash") KP("T", "V", "W", "backslash")(-2leftstemloc - px - o - u) KL;
for  $t :=$  "A", "Agrave", "Aacute", "Acircumflex", "Atilde", "Adieresis",
  "Aring": LK( $t$ ) KP("C", "Ccedilla")(-leftstemloc) KP("E", "Egrave",
  "Eacute", "Ecircumflex", "Edieresis")(-leftstemloc) KP("F")(-1.5leftstemloc)
KP("G")(-leftstemloc) KP("N", "Ntilde")(-1.5leftstemloc)
KP("I", "Igrave", "Iacute", "Icircumflex", "Idieresis")(-1.5leftstemloc - xu)
KP("J")(-leftstemloc) KP("L")(-leftstemloc) KP("Lslash")(-2leftstemloc)
KP("M")(-1.5leftstemloc) KP("O", "OE", "Ograve", "Oacute", "Ocircumflex",
  "Otilde", "Odieresis", "Openbaseleft")(-2leftstemloc) KP("Q",
  "Qwave")(-2leftstemloc) KP("T")(-leftstemloc - px - o - u)
KP("U", "Ugrave", "Uacute", "Ucircumflex", "Udieresis")(-leftstemloc)
KP("V", "W")(-2leftstemloc - px - o - u) KP("backslash")(-2leftstemloc - px - o - u)
KP("a", "agrave", "aacute", "acircumflex", "atilde", "adieresis", "aring",
  "ae")(-leftstemloc) KP("c", "ccedilla")(-leftstemloc) KP("d")(-leftstemloc)
KP("e", "egrave", "eacute", "ecircumflex", "edieresis")(-leftstemloc)
KP("f", "t", "fi", "fl", "ffi", "ffl", "ff", "germandbls")(-2xu)
KP("g")(-leftstemloc) KP("o", "eth", "ograve", "oacute", "ocircumflex",
  "otilde", "odieresis", "oe")(-leftstemloc) KP("q")(-leftstemloc)
KP("u", "ugrave", "uacute", "ucircumflex", "udieresis")(-leftstemloc)
KP("v")(-px - .5leftstemloc) KP("w")(-px - .5leftstemloc) KP("y", "yacute",
  "ydieresis")(-px) KL; endfor
LK("B") KP("A", "Agrave", "Aacute", "Acircumflex", "Atilde", "Adieresis",
  "Aring", "AE")(-leftstemloc) KP("I", "Igrave", "Iacute", "Icircumflex",
  "Idieresis")(-xu) KP("T")(-.5leftstemloc) KP("V", "W")(-leftstemloc)
KP("X")(-leftstemloc) KP("Y", "Ydieresis", "Yacute")(-leftstemloc) KP("Z",
  "Zcaron")(-.5leftstemloc) KL;
for  $t :=$  "C", "Ccedilla": LK( $t$ ) KP("O", "Ograve", "Oacute", "Ocircumflex",
  "Otilde", "Odieresis", "Openbaseleft", "OE")(-leftstemloc)
KP("Q")(-leftstemloc) KL; endfor
for  $t :=$  "D", "Eth": LK( $t$ ) KP("A", "Agrave", "Aacute", "Acircumflex", "Atilde",
  "Adieresis", "Aring", "AE")(-leftstemloc) KP("V", "W")(-leftstemloc)
KP("X")(-leftstemloc) KP("Y", "Yacute", "Ydieresis")(-leftstemloc)
KP("Z", "Zcaron")(-.5leftstemloc) KL; endfor
LK("F") KP("A", "Agrave", "Aacute", "Acircumflex", "Atilde", "Adieresis",
  "Aring", "AE")(-leftstemloc - xgap) KP("J")(-leftstemloc - xgap) KL;
LK("G") KP("A", "Agrave", "Aacute", "Acircumflex", "Atilde", "Adieresis",
  "Aring", "AE")(-leftstemloc) KL;
LK("J") KP("A", "Agrave", "Aacute", "Acircumflex", "Atilde", "Adieresis",
  "Aring", "AE")(-leftstemloc) KL;
LK("K") KP("C", "Ccedilla")(-1.5leftstemloc) KP("E", "Egrave", "Eacute",
  "Ecircumflex", "Edieresis")(-2leftstemloc) KP("F")(-2leftstemloc)
KP("G")(-1.5leftstemloc) KP("I", "Igrave", "Iacute", "Icircumflex",
  "Idieresis")(-2leftstemloc) KP("J")(-1.5leftstemloc)
KP("L")(-1.5leftstemloc) KP("Lslash")(-1.5leftstemloc - xu)
KP("M")(-2leftstemloc) KP("N", "Ntilde")(-2leftstemloc) KP("O", "OE",
  "Ograve", "Oacute", "Ocircumflex", "Otilde", "Odieresis",
  "Openbaseleft")(-2leftstemloc) KP("Q", "Qwave")(-2leftstemloc)
KP("T")(-1.5leftstemloc) KP("U", "Ugrave", "Uacute", "Ucircumflex",
  "Udieresis")(-1.5leftstemloc) KP("V", "W")(-2leftstemloc)
KP("a", "agrave", "aacute", "acircumflex", "atilde", "adieresis",

```

```

"aring", "ae")(-leftstemloc) KP("c", "ccedilla")(-leftstemloc)
KP("d")(-leftstemloc) KP("e", "egrave", "eacute", "ecircumflex",
"edieresis")(-leftstemloc) KP("f", "t", "fi", "fl", "ffi", "ffl", "ff",
"germandbls")(-2xu) KP("g")(-leftstemloc) KP("o", "eth", "ograve",
"oacute", "ocircumflex", "otilde", "odieresis", "oe")(-leftstemloc)
KP("q")(-leftstemloc) KP("u", "ugrave", "uacute", "ucircumflex",
"udieresis")(-leftstemloc) KP("v")(-px - .5leftstemloc)
KP("w")(-px - .5leftstemloc) KP("y", "yacute", "ydieresis")(-px)
KL;
for t := "L", "Lslash": LK(t) KP("I", "Igrave", "Iacute", "Icircumflex",
"Idieresis")(-xu) KP("O", "Ograve", "Oacute", "Ocircumflex",
"Otilde", "Odieresis", "Oopenbaseleft")(-leftstemloc) KP("Q",
"Qwave")(-leftstemloc) KP("T")(-2leftstemloc - xgap)
KP("V", "W")(-2leftstemloc - xgap) KL; endfor
for t := "0", "0grave", "0acute", "0circumflex", "0tilde", "0dieresis",
"0openbaseleft": LK(t) KP("A", "Agrave", "Aacute", "Acircumflex", "Atilde",
"Adieresis", "Aring", "AE")(-2leftstemloc) KP("I", "Igrave", "Iacute",
"Icircumflex", "Idieresis")(-xu) KP("J")(-.5leftstemloc)
KP("T")(-2leftstemloc) KP("V", "W")(-2leftstemloc) KP("X")(-2leftstemloc)
KP("Y", "Ydieresis", "Yacute")(-2leftstemloc) KP("Z",
"Zcaron")(-2leftstemloc) KL; endfor
LK("P") KP("A", "Agrave", "Aacute", "Acircumflex", "Atilde", "Adieresis",
"Aring", "AE")(-2leftstemloc - px - o - u) KP("I", "Igrave", "Iacute",
"Icircumflex", "Idieresis")(-xu) KP("J")(-leftstemloc - px)
KP("V", "W")(-leftstemloc) KP("X")(-1.5leftstemloc) KP("Y", "Ydieresis",
"Yacute")(-1.5leftstemloc) KP("Z", "Zcaron")(-.5leftstemloc) KL;
for t := "Q", "Qwave": LK(t) KP("I", "Igrave", "Iacute", "Icircumflex",
"Idieresis")(-xu) KP("J")(-.5leftstemloc) KP("T")(-2leftstemloc)
KP("V", "W")(-2leftstemloc) KP("X")(-.5leftstemloc) KP("Y", "Ydieresis",
"Yacute")(-.5leftstemloc) KP("Z", "Zcaron")(-.5leftstemloc) KL; endfor
LK("R") KP("I", "Igrave", "Iacute", "Icircumflex", "Idieresis")(-xu)
KP("J")(-2leftstemloc) KP("T")(-.5leftstemloc) KP("V", "W")(-leftstemloc)
KP("c", "ccedilla")(-2leftstemloc)
KP("d")(-2leftstemloc) KP("e", "egrave", "eacute", "ecircumflex",
"edieresis")(-2leftstemloc) KP("g")(-2leftstemloc) KP("o", "eth", "ograve",
"oacute", "ocircumflex", "otilde", "odieresis", "oe")(-2leftstemloc)
KP("q")(-2leftstemloc) KL;
for t := "S", "Scaron": LK(t) KP("A", "Agrave", "Aacute", "Acircumflex",
"Atilde", "Adieresis", "Aring", "AE")(-leftstemloc) KP("f", "t", "fi",
"fl", "ffi", "ffl", "ff", "germandbls")(-leftstemloc)
KP("v")(-1.5leftstemloc) KP("w")(-1.5leftstemloc) KP("x")(-1.5leftstemloc)
KP("y")(-1.5leftstemloc) KP("z")(-leftstemloc) KL; endfor
LK("T") KP("A", "Agrave", "Aacute", "Acircumflex", "Atilde", "Adieresis",
"Aring", "AE")(-leftstemloc - 2xu - o - u) KP("C", "Ccedilla")(-.5leftstemloc)
KP("G")(-.5leftstemloc) KP("J")(-leftstemloc - px) KP("O", "Ograve",
"Oacute", "Ocircumflex", "Otilde", "Odieresis", "Oopenbaseleft",
"OE")(-2leftstemloc) KP("Q", "Qwave")(-2leftstemloc) KP("S",
"Scaron")(-.5leftstemloc) KP("a", "ae")(-2leftstemloc - 2xu)
KP("c", "ccedilla")(-2leftstemloc - 2xu) KP("d")(-2leftstemloc - 2xu)
KP("e")(-2leftstemloc - 2xu) KP("f", "t", "fi", "fl", "ffi", "ffl", "ff",
"germandbls")(-2xu) KP("g")(-2leftstemloc - 2xu) KP("m")(-2leftstemloc - 2xu)
KP("n")(-2leftstemloc - 2xu) KP("o", "oe")(-2leftstemloc - 2xu)
KP("p")(-2leftstemloc - 2xu) KP("q")(-2leftstemloc - 2xu)
KP("r")(-2leftstemloc - 2xu) KP("s")(-2leftstemloc - 2xu)
KP("u")(-2leftstemloc - 2xu) KP("v")(-2leftstemloc - 2xu)
KP("w")(-2leftstemloc - 2xu) KP("x")(-2leftstemloc - 2xu)
KP("y")(-2leftstemloc - 2xu) KP("z")(-2leftstemloc - 2xu) KL;
for t := "U", "Ugrave", "Uacute", "Ucircumflex", "Udieresis": LK(t) KP("A",

```

```

"Agrave", "Aacute", "Acircumflex", "Atilde", "Adieresis", "Aring",
"AE")(-leftstemloc) KL; endfor
for t := "V", "W": LK(t) KP("A", "Agrave", "Aacute", "Acircumflex", "Atilde",
"Adieresis", "Aring", "AE")(-2leftstemloc - px - o - u) KP("C",
"Ccedilla")(-leftstemloc) KP("G")(-leftstemloc) KP("J")(-leftstemloc - px)
KP("O", "OE", "Ograve", "Oacute", "Ocircumflex", "Otilde", "Odieresis",
"Openbaseleft")(-2leftstemloc) KP("Q", "Qwave")(-2leftstemloc)
KP("S", "Scaron")(-leftstemloc) KP("slash")(-2leftstemloc - px - o - u)
KP("a", "agrave", "aacute", "acircumflex", "atilde", "adieresis", "aring",
"ae")(-px) KP("c", "ccedilla")(-leftstemloc - px) KP("d")(-leftstemloc - px)
KP("e")(-leftstemloc - px) KP("f", "t", "fi", "fl", "ffi", "ffl", "ff",
"germandbls")(-2xu) KP("g")(-leftstemloc - px) KP("m")(-2leftstemloc)
KP("n")(-2leftstemloc) KP("o", "oe")(-leftstemloc - px) KP("p")(-2leftstemloc)
KP("q")(-leftstemloc - px) KP("r")(-2leftstemloc) KP("s")(-leftstemloc - px)
KP("u")(-2leftstemloc) KP("v")(-2leftstemloc) KP("x")(-2leftstemloc)
KP("y")(-2leftstemloc) KP("z")(-2leftstemloc) KL; endfor
LK("X") KP("C", "Ccedilla")(-leftstemloc) KP("G")(-leftstemloc)
KP("J")(-2leftstemloc) KP("O", "Ograve", "Oacute", "Ocircumflex",
"Otilde", "Odieresis", "Openbaseleft", "OE")(-2leftstemloc)
KP("Q", "Qwave")(-2leftstemloc) KP("a", "ae")(-leftstemloc) KP("c",
"ccedilla")(-leftstemloc) KP("d")(-leftstemloc) KP("e")(-leftstemloc)
KP("f", "t", "fi", "fl", "ffi", "ffl", "ff", "germandbls")(-2xu)
KP("g")(-leftstemloc) KP("o", "oe")(-leftstemloc) KP("q")(-leftstemloc)
KP("u")(-leftstemloc) KP("v")(-px) KP("w")(-px) KP("y")(-2leftstemloc) KL;
for t := "Y", "Yacute", "Ydieresis": LK(t) KP("A", "Agrave", "Aacute",
"Acircumflex", "Atilde", "Adieresis", "Aring",
"AE")(-2leftstemloc - px - o - u - 1/3 px) KP("C", "Ccedilla")(-leftstemloc)
KP("G")(-leftstemloc) KP("J")(-2leftstemloc - px - o - u) KP("O", "OE", "Ograve",
"Oacute", "Ocircumflex", "Otilde", "Odieresis",
"Openbaseleft")(-2leftstemloc) KP("Q", "Qwave")(-2leftstemloc)
KP("S", "Scaron")(-2leftstemloc) KP("slash")(-2leftstemloc - px - o - u)
KP("a", "ae")(-px) KP("c", "ccedilla")(-px)
KP("d")(-px) KP("e")(-px) KP("f", "t", "fi", "fl", "ffi",
"ffl", "ff", "germandbls")(-2xu) KP("g")(-px) KP("o",
"oe")(-px) KP("q")(-px) KP("u")(-px) KP("v")(-px)
KP("w")(-px) KP("y")(-2leftstemloc) KL; endfor
for t := "Z", "Zcaron": LK(t) KP("O", "OE", "Ograve", "Oacute", "Ocircumflex",
"Otilde", "Odieresis", "Openbaseleft")(-.5leftstemloc) KP("Q",
"Qwave")(-.5leftstemloc) KP("f", "t", "fi", "fl", "ffi", "ffl", "ff",
"germandbls")(-2xu) KP("v")(-2leftstemloc) KP("w")(-2leftstemloc)
KP("y")(-1.5leftstemloc) KL; endfor
for t := "a", "agrave", "aacute", "acircumflex", "atilde", "adieresis",
"aring": LK(t) KP("v")(-leftstemloc) KP("w")(-leftstemloc) KP("y", "yacute",
"ydieresis")(-leftstemloc) KL; endfor
LK("b") KP("v")(-leftstemloc) KP("w")(-leftstemloc) KP("x")(-leftstemloc)
KP("y", "yacute", "ydieresis")(-leftstemloc) KL;
for t := "egrave", "eacute", "ecircumflex", "edieresis", "ae", "oe":
LK(t) KP("v")(-leftstemloc) KP("w")(-leftstemloc) KP("x")(-leftstemloc)
KP("y", "yacute", "ydieresis")(-leftstemloc) KL; endfor
LK("f") KP("a", "agrave", "aacute", "acircumflex", "atilde", "adieresis",
"aring", "ae")(-xu) KP("c", "ccedilla")(-xu) KP("d")(-xu) KP("e", "egrave",
"eacute", "ecircumflex", "edieresis")(-xu)
KP("t", "fi", "fl", "ffi", "ffl", "ff", "germandbls")(-xu)
KP("g")(-xu) KP("igrave", "iacute", "icircumflex", "idieresis")(-xu)
KP("j")(-xu) KP("m")(-xu) KP("n", "ntilde")(-xu) KP("o", "ograve",
"oacute", "ocircumflex", "otilde", "odieresis", "oe")(-xu - .5leftstemloc)
KP("p")(-xu) KP("q")(-xu) KP("r")(-xu) KP("s", "scaron")(-xu) KP("u",
"ugrave", "uacute", "ucircumflex", "udieresis")(-xu) KP("v")(-xu)

```

KP("w")(-xu) KP("x")(-xu) KP("y", "yacute", "ydieresis")(-xu)
KP("z", "zcaron")(-xu) LP("f")("ff") LP("i")("fi") LP("l")("fl") KL;
LK("ff") KP("a", "agrave", "aacute", "acircumflex", "atilde", "adieresis",
"aring", "ae")(-xu) KP("c", "ccedilla")(-xu) KP("d")(-xu) KP("e", "egrave",
"eacute", "ecircumflex", "edieresis")(-xu)
KP("f", "t", "fi", "fl", "ffi", "ffl", "ff", "germandbls")(-xu)
KP("g")(-xu) KP("igrave", "iacute", "icircumflex", "idieresis")(-xu)
KP("j")(-xu) KP("m")(-xu) KP("n", "ntilde")(-xu) KP("o", "ograve",
"oacute", "ocircumflex", "otilde", "odieresis", "oe")(-xu - .5leftstemloc)
KP("p")(-xu) KP("q")(-xu) KP("r")(-xu) KP("s", "scaron")(-xu) KP("u",
"ugrave", "uacute", "ucircumflex", "udieresis")(-xu) KP("v")(-xu)
KP("w")(-xu) KP("x")(-xu) KP("y", "yacute", "ydieresis")(-xu)
KP("z", "zcaron")(-xu) LP("i")("ffi") LP("l")("ffl") KL;
LK("h") KP("v")(-leftstemloc) KP("w")(-leftstemloc) KP("y", "yacute",
"ydieresis")(-leftstemloc) KL;
LK("k") KP("c", "ccedilla")(-leftstemloc) KP("d")(-leftstemloc)
KP("e", "egrave", "eacute", "ecircumflex", "edieresis")(-leftstemloc)
KP("g")(-leftstemloc) KP("o")(-leftstemloc) KP("q")(-leftstemloc) KL;
LK("m") KP("v")(-leftstemloc) KP("w")(-leftstemloc) KP("y", "yacute",
"ydieresis")(-leftstemloc) KL;
for t := "n", "ntilde": LK(t) KP("v")(-leftstemloc) KP("w")(-leftstemloc)
KP("y", "yacute", "ydieresis")(-leftstemloc) KL; endfor
LK("o") KP("v")(-leftstemloc) KP("w")(-leftstemloc) KP("x")(-leftstemloc)
KP("y", "yacute", "ydieresis")(-leftstemloc) KL;
LK("p") KP("v")(-leftstemloc) KP("w")(-leftstemloc) KP("x")(-leftstemloc)
KP("y", "yacute", "ydieresis")(-leftstemloc) KL;
for t := "s", "scaron": LK(t) KP("v")(-leftstemloc) KP("w")(-leftstemloc)
KP("x")(-leftstemloc) KP("y", "yacute", "ydieresis")(-leftstemloc)
KP("z", "zcaron")(-leftstemloc) KL; endfor
LK("t") KP("a", "agrave", "aacute", "acircumflex", "atilde", "adieresis",
"aring", "ae")(-leftstemloc) KL;
LK("v") KP("a", "agrave", "aacute", "acircumflex", "atilde", "adieresis",
"aring", "ae")(-leftstemloc) KP("c", "ccedilla")(-leftstemloc)
KP("d")(-leftstemloc) KP("e", "egrave", "eacute", "ecircumflex",
"edieresis")(-leftstemloc) KP("g")(-leftstemloc) KP("o", "ograve",
"oacute", "ocircumflex", "otilde", "odieresis", "oe")(-leftstemloc)
KP("q")(-leftstemloc) KP("s", "scaron")(-leftstemloc) KL;
LK("w") KP("a", "agrave", "aacute", "acircumflex", "atilde", "adieresis",
"aring", "ae")(-leftstemloc) KP("c", "ccedilla")(-leftstemloc)
KP("d")(-leftstemloc) KP("e", "egrave", "eacute", "ecircumflex",
"edieresis")(-leftstemloc) KP("g")(-leftstemloc) KP("o", "ograve",
"oacute", "ocircumflex", "otilde", "odieresis", "oe")(-leftstemloc)
KP("q")(-leftstemloc) KP("s", "scaron")(-leftstemloc) KL;
LK("x") KP("a", "agrave", "aacute", "acircumflex", "atilde", "adieresis",
"aring", "ae")(-leftstemloc) KP("c", "ccedilla")(-leftstemloc)
KP("d")(-leftstemloc) KP("e", "egrave", "eacute", "ecircumflex",
"edieresis")(-leftstemloc) KP("g")(-leftstemloc) KP("o", "ograve",
"oacute", "ocircumflex", "otilde", "odieresis", "oe")(-leftstemloc)
KP("q")(-leftstemloc) KL;
for t := "y", "yacute", "ydieresis": LK(t) KP("a", "agrave", "aacute",
"acircumflex", "atilde", "adieresis", "aring", "ae")(-leftstemloc) KP("c",
"ccedilla")(-leftstemloc) KP("d")(-leftstemloc) KP("e", "egrave", "eacute",
"ecircumflex", "edieresis")(-leftstemloc) KP("g")(-leftstemloc) KP("o",
"ograve", "oacute", "ocircumflex", "otilde", "odieresis",
"oe")(-leftstemloc) KP("q")(-leftstemloc) KP("s",
"scaron")(-leftstemloc) KL; endfor
LK("hyphen") LP("hyphen")("endash") KL;
LK("endash") LP("hyphen")("emdash") KL;

```
LK("quoteleft") LP("quoteleft")("quotedblleft") KL;  
LK("quoteright") LP("quoteright")("quotedblright") KL;  
LK("quotesinglbase") LP("quotesinglbase")("quotedblbase") KL;  
endfont;
```

GLYPH LIST: breve 11 dotaccent 12 ring 13 hungarumlaut 14 ogonek 15 caron 16
 dotlessi 17 fraction 18 fi 19 fl 20 ffi 21 ffl 22 ff 23 space 24 exclam 25 quotedbl 26
 numbersign 27 dollar 28 zerosuperior 30 percent 31 ampersand 32 quotesingle 33 parenleft 34
 parenright 35 asterisk 36 plus 37 comma 38 hyphen 39 period 40 slash 41 zero 42 one 43
 two 44 three 45 four 46 five 47 six 48 seven 49 eight 50 nine 51 colon 52 semicolon 53
 less 54 equal 55 greater 56 question 57 at 58 A 59 B 60 C 61 D 62 E 63 F 64 G 65
 H 66 I 67 J 68 K 69 L 70 Lslash 71 M 72 N 73 O 74 Oopenbaseleft 75 P 76 Q 77
 Qwave 78 R 79 S 80 S.alt 81 T 82 U 83 V 84 W 85 X 86 Y 87 Z 88 Zcaron 89
 bracketleft 90 backslash 91 bracketright 92 asciicircum 93 underscore 94 grave 95 a 96 b 97
 c 98 d 99 e 100 f 101 g 102 h 103 i 104 dotlessj 105 j 106 k 107 l 108 lslash 109
 m 110 n 111 o 112 p 113 q 114 r 115 s 116 t 117 u 118 v 119 w 120 x 121 y 122
 y.alt 123 z 124 zcaron 125 braceleft 126 bar 127 braceright 128 asciitilde 129 Euro 130
 quotesinglbase 131 florin 132 quotedblbase 133 ellipsis 134 dagger 135 daggerdbl 136
 circumflex 137 perthousand 138 Scaron 139 guilsinglleft 140 OE 141 quoteleft 142
 quoteright 143 quotedblleft 144 quotedblright 145 bullet 146 endash 147 emdash 148 tilde 149
 trademark 150 scaron 151 guilsinglright 152 oe 153 dieresis 154 Ydieresis 155 exclamdown 156
 cent 157 sterling 158 currency 159 yen 160 brokenbar 161 section 162 copyright 163
 ordfeminine 164 guillemotleft 165 logicalnot 166 minus 167 registered 168 macron 169
 degree 170 plusminus 171 twosuperior 172 threesuperior 173 foursuperior 174 acute 175 mu 176
 paragraph 177 periodcentered 178 cedilla 179 onesuperior 180 ordmasculine 181
 guillemotright 182 onequarter 183 onehalf 184 threequarters 185 questiondown 186 Agrave 187
 Aacute 188 Acircumflex 189 Atilde 190 Adieresis 191 Aring 192 AE 193 Ccedilla 194
 Egrave 195 Eacute 196 Ecircumflex 197 Edieresis 198 Igrave 199 Iacute 200 Icircumflex 201
 Idieresis 202 Eth 203 Ntilde 204 Ograve 205 Oacute 206 Ocircumflex 207 Otilde 208
 Odieresis 209 multiply 210 Oslash 211 Ugrave 212 Uacute 213 Ucircumflex 214 Udieresis 215
 Yacute 216 Thorn 217 germandbls 218 szlig 219 agrave 220 aacute 221 acircumflex 222
 atilde 223 adieresis 224 aring 225 ae 226 ccedilla 228 egrave 229 eacute 230 ecircumflex 231
 edieresis 232 igrave 233 iacute 234 icircumflex 235 idieresis 236 eth 237 ntilde 238 ograve 239
 oacute 240 ocircumflex 241 otilde 242 odieresis 243 divide 244 oslash 245 ugrave 246
 uacute 247 ucircumflex 248 udieresis 249 yacute 250 thorn 251 ydieresis 252